

TRILOGY SERIES OPERATIONS MANUAL

Models: T2030 T2030V
 T2440 T2440V
 T2850 T2850V



Warranty Statement

MATHEWS COMPANY LIMITED WARRANTY FOR WHOLE GOODS





Except as otherwise set forth herein, Mathews Company (Seller) warrants that the equipment supplied by Seller to Buyer shall be free from defects in materials and workmanship when properly installed and operated under normal conditions and in accordance with all applicable instruction manuals. This limited warranty shall expire two (2) years from the date of shipment from Seller's Crystal Lake, Illinois, U.S.A. facility. In addition, for a period of five (5) years from the date of shipment from Seller's Crystal Lake, Illinois, U.S.A. facility, Seller will re-balance M-C Shredder rotors for Buyer at Seller's Crystal Lake, Illinois, U.S.A. facility, provided that the rotors did not become unbalanced through abnormal use by Buyer or were not damaged by Buyer in any way.



To obtain consideration under this limited warranty, Buyer must first notify Seller in Crystal Lake, Illinois, U.S.A., stating in what respects the equipment is believed by Buyer to be defective and providing a list of the parts at issue. Additionally, Buyer must complete a warranty request form stating the machine serial number. Upon receipt by Seller of such notice from Buyer, Buyer may receive authorization from Seller to return the parts. If parts are to be scrapped locally, Buyer will be so advised. If Seller provides Buyer with authorization to return the parts, Buyer shall return such parts to Seller's facility in Crystal Lake, Illinois, U.S.A., transportation prepaid, for examination by Seller. No parts shall be returned to Seller unless Buyer first obtains a return authorization number from Seller. If, in Seller's sole judgment, the parts returned by Buyer are defective and covered under this limited warranty, Seller shall have the option of repairing, rebuilding or replacing such parts. This limited warranty shall not apply to parts which, in Seller's sole judgment, have been the subject of negligence, abuse, accident, misapplication, tampering, alteration, improper adjustment, or electrical problems caused by low voltage conditions; nor shall it apply to consumables, such as belts; nor shall it apply to parts damaged by acts of God, war or civil insurrection, acts of terrorism, improper installation, operation, maintenance or storage, or other than normal application, use or service, including, without limitation, operational failures caused by corrosion, erosion, wear and tear, rust or other foreign materials in the system in which they are utilized.

Failure to give notice within the warranty period shall be a waiver of this limited warranty and no assistance or other action thereafter taken by Seller shall be deemed to extend or revive the warranty period. This limited warranty covers only whole goods and shall not apply to replacement parts or upgrade kits. A separate warranty statement published by Seller covers the warranty on parts and upgrade kits. This limited warranty shall not apply to any products, parts, accessories or other equipment not manufactured by Seller, provided that Seller, upon request by Buyer, shall advise Buyer of any warranties known to Seller that may be offered by the manufacturer of such equipment. This limited warranty shall not cover, and Seller shall not under any circumstances be liable for, damages for injuries to persons or property; loss of crops or other products; losses caused by harvest delays; loss of profits; loss of use; cost of rental equipment; expenses of labor, travel or other items relating to the removal or replacement of defective parts; damages resulting from the removal of defective parts or the installation of repaired, rebuilt or replaced parts; expenses relating to the transportation of parts to and from Seller's facility; any consequential, incidental, contingent or special damages, whether arising in contract, in tort or under statute; or any other damages or expenses not agreed upon in writing by Seller, even if Seller has been advised of the potential for any such damages or expenses.

THIS LIMITED WARRANTY IS IN LIEU OF ALL WARRANTIES, EXPRESS OR IMPLIED, INCLUDING, WITHOUT LIMITATION, ALL WARRANTIES OF MERCHANTABILITY AND FITNESS FOR A PARTICULAR PURPOSE OR USE. No person is authorized to give any other warranty or to assume any other liability on Seller's behalf.

Table of Contents

	Introduction	1.1
	Overview	1.1
	Grain Drying Principles	1.1
	Air	1.1
	Heat	1.1
	Time.....	1.1
	Owner / Operator Notes	1.2
	Warranty Registration	1.2
	Model / Serial Number / Specifications	1.2
	Safety	1.3
	Lock-out / Tag-out Requirements	1.4
	Blocks.....	1.5
	Specifications	2.1
	T2030 Dimensions	2.2
	T2440 Dimensions	2.3
	T2850 Dimensions	2.4
	Equipment Overview	3.1
	Main Dryer Components	3.1
	High Voltage Cabinet	3.3
	Pinnacle Lite Remote Cabinet	3.4
	Burner Control Cabinet	3.5
	Discharge Moisture Sampler	3.7
	Gas Train	3.8
	LPG Gas Train (Optional CGA Requirements).....	3.8
	Burner	3.10
	Maxon NP Burner	3.10
	Operating Procedures	4.1
	Overview	4.1
	Component Adjustments	4.1
	Air Pressure Switch	4.1
	High Limit Switch	4.2
	Grain Fill System	4.4
	Temperature Controller	4.6
	Variable Frequency Drive (VFD).....	4.10
	Changing Variable Frequency Drive Parameters.....	4.11
	Operational Procedures	4.13
	Selecting Mode of Operation.....	4.13
	First Time Start-Up.....	4.14
	Daily Shut-Down	4.15
	Daily Start-Up	4.16
	End-of-Season Shut-Down	4.17
	Suggested Plenum Temperatures	4.18
	Suggested Discharge Rate.....	4.18
	Maintenance	5.1
	Overview	5.1
	Pre-Season Checks	5.1
	Grain Fill & Discharge System	5.1

Belt Adjustment.....	5.1
Fans & Burners	5.2
Lubrication.....	5.3
Seasonal Cleaning	5.3
Outer Screens	5.4
Inner Screens	5.4
Post-Season Maintenance	5.4
 Troubleshooting	6.1
Diagnosing a Dryer Shutdown	6.1
Safety Circuit Overview	6.1
Safety Circuit Schematic	6.3
Customer Interface	6.4
Customer Connections	6.4
Temperature Controller.....	6.4
Always Overshoots the Setpoint Temperature	6.4
Unable to Reach Setpoint Temperature	6.4
Plenum Temperature Will Not Hold Satisfactorily	6.5
Controller Fault Codes	6.5
Variable Frequency Drive (VFD)	6.6
Display Faults.....	6.6
Fault Code Description	6.6
Common Diagnostic Issues.....	6.7
 Notes	7.1

Introduction

This volume of the manual is intended to provide you with an overview of the construction, operation and maintenance of your Mathews Company Trilogy Series Grain Dryer. The information contained herein is divided into 6 sections which are: Introduction, Specifications, Equipment Overview, Operating Procedures, Maintenance and Troubleshooting.

Overview

The majority of the information in this manual applies to all Trilogy Series Grain Dryers, however it is important to understand that there are different configurations and options that may or may not be included on your particular machine. In most cases it is indicated where there is a feature that may not be configured on all machines with a note of "if equipped" or "optional".

Grain Drying Principles

Understanding fundamental grain drying principles is an important element of the operation of your grain dryer. As such, the following is a brief overview of the grain drying process.

Grain drying is a mass transfer process consisting of the removal of water by evaporation from the grain. In its most simplest concept, drying consists of three main components, Air, Heat and Time:

Air

Ambient air is supplied to a fan that is horizontally mounted on the exterior of the dryer which pushes it through a burner to raise its temperature, then forces it across the column of grain. The function of the heated air is to facilitate a heat and mass transfer process. As the heated air passes over the grain, the heat from the air is transferred to the grain thereby elevating the temperature of the grain (heat transfer). Similarly, as the grain is heated, the moisture of the grain will start to exit to its surroundings as the equilibrium moisture of the grain is reached. This leads to the transfer of moisture from the grain to the air (mass transfer).

Heat

The accurate control of this heating process is what makes the equipment energy efficient. As the ambient conditions (temperature and relative humidity) change, as well as the desired plenum setpoint, the gas control system will respond to opening or closing to allow more or less fuel to flow to the burner.

Time

The time element of grain drying refers to the time the grain is spent inside the dryer. The time that the grain is exposed to the heated air determines how much moisture is driven out of the grain. The longer the exposure, more moisture removal occurs. As such, the best method for controlling the amount of moisture removal in the grain is to increase or decrease the grain's retention time by increasing or decreasing the discharge metering speed. The slower the metering system operates, the longer the grain is exposed to the heated air and the moisture removal is increased. The faster the metering system



operates, the shorter the grain is exposed to the heated air and the moisture removal is decreased. The easiest way to keep good grain quality and accurate control is to keep heat and air consistent while varying only grain retention time, which has proven to be the most common and efficient way to dry grain.

Owner / Operator Notes

Before operating your grain dryer, it is strongly encouraged that you read the contents of this Operations Manual as well as Volume 2 - Pinnacle Lite Controls Manual. It will be important for you to become familiar with the controls, adjustments and settings required to obtain efficient operation.

To keep your dryer operating at its peak efficiency, it should be cleaned, lubricated, belts tensioned, ignition system checked, and the fill/takeaway in good operating condition. Refer to the Maintenance Section to understand the required maintenance and suggested intervals. The Pre-Season check can be made when the dryer is empty. Any necessary repairs or adjustments should be completed so that the dryer will be ready to operate before your drying season begins.

Warranty Registration

It is important to send in your warranty registration card as soon as your new grain dryer is delivered. Not only does the card validate your warranty, but it also assists Mathews Company in disseminating information particular to your dryer model.

Model / Serial Number / Specifications

The model and serial number of your Mathews Company continuous flow grain dryer are stamped on plates located on the base of the dryer as shown:

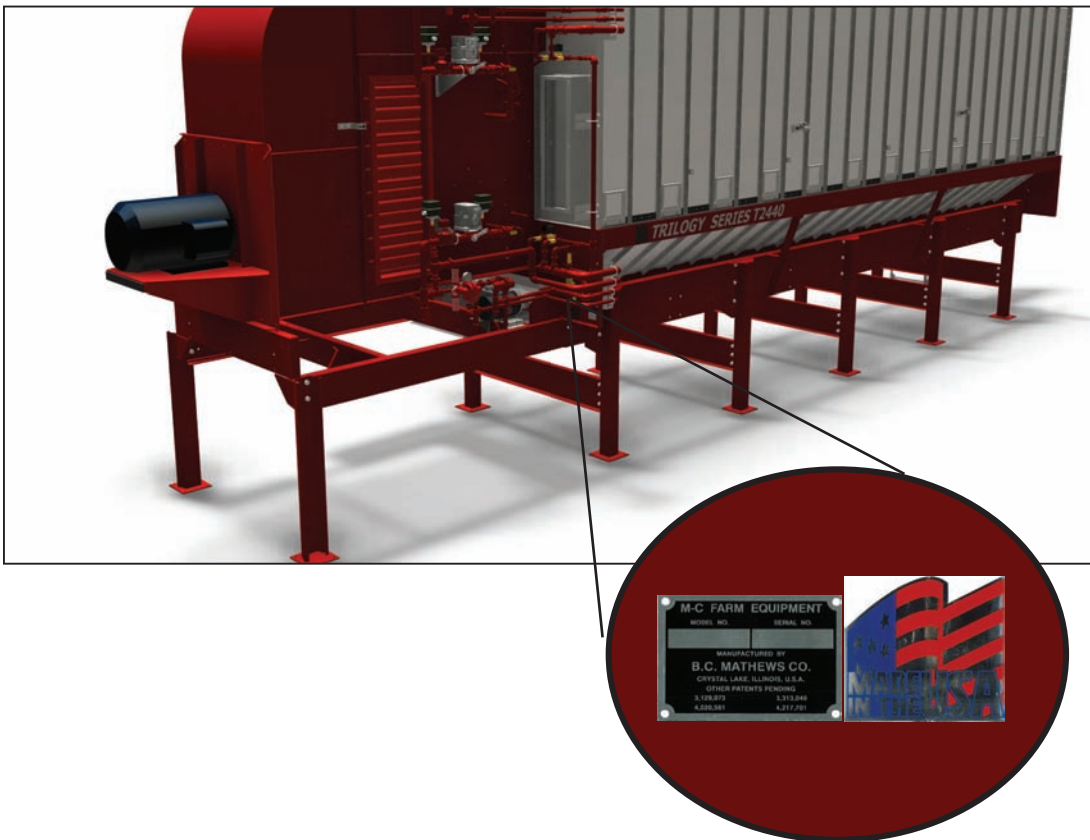

Specifications for the machine will be located on the nameplate which is located on the inside door of the High Voltage Cabinet as well as on the inside of the Remote Cabinet. A sample nameplate is shown below:



Mathews Company
 500 Industrial Avenue
 Crystal Lake, IL 60012, U.S.A
 WARNING - For Outdoor Installation Only

Safety

While operating or performing maintenance on your machine, it is important to make safety a top priority. Be sure to read and understand the operations manual before attempting to operate the dryer. The following list of best practices should be followed to help ensure safe operation:

1. Keep ALL guards, access doors, covers, safety decals, and safety devices in place and securely fastened. Never operate the dryer while guards are removed.
2. Keep all untrained personnel away from system components and control panels at all times.
3. Never attempt to operate the unit by jumping or otherwise bypassing any safety devices.
4. Always open the main power supply disconnect switch and lock it in the open position with an approved lockout device prior to performing any service or maintenance work on the fan or burner unit.
5. Lock out power before removing guards, access doors, and covers.
6. Keep hands, feet and clothing away from all rotating parts.
7. Electrical repairs should be performed by trained and qualified personnel only. Failure to follow safe electrical procedures can result in serious injury.
8. If it should become necessary to perform checks on system components or high voltage test with energized circuits, proceed with extreme caution and follow all established safety practices.
9. Routinely check for any gas leaks.
10. Do not allow children or bystanders to be near the grain dryer or grain handling machinery while it is operating.
11. Do not operate the grain dryer without all safety shields in place and secure.



Lock-out / Tag-out Requirements

The purpose of a lock-out / tag-out procedure is to prevent injury and/or death to personnel by requiring that certain precautions be taken before servicing or repairing equipment. This includes shutting off and locking-out the electrical power source of the equipment. A standard Lock-out / Tag-out program is explained as follows:

1. All maintenance personnel are issued a suitable lock (or locks) that is durable. The lock has the individual's name and other identification on it. Each worker must have his/her own lock and the only key to that lock. In addition, locks can be color coded to indicate different shifts or types of services.
2. Each person who will be working on the machinery should put a lock on the machine's lockout device(s). Each lock must remain on the machine until the work is completed. Only the individual who placed the lock should remove his/her lock.
3. Check to be sure that no one is operating the machinery before turning off the power. The machine operator must be informed before the power is turned off. Sudden loss of power could cause an accident.
4. Any mechanism under load or pressure, such as springs, should be released and blocked.
5. All energy sources that could activate the machine must be locked-out.
6. The main valve or main electrical disconnect must be tested to be sure that the power to the machine is off.
7. Electrical circuits must be checked by qualified persons with proper and calibrated electrical testing equipment. An electrical failure could energize the equipment, even if the switch is in the OFF position. Stored energy in electrical capacitors should be safely discharged.
8. Return disconnects and operating controls to the OFF position after each test.
9. Attach accident prevention tags. The tags will give the reason for placing the tag, the name of the person placing the tag, how he/she may be contacted, and the date and time the tag was placed.

The following are some images of lock out tag out material that can be used for locking out the work area.





Blocks

Suitable blocks are another important safety device for making a piece of equipment safe to be repaired or serviced. Blocks must be placed under raised dies, lifts, or any equipment that might inadvertently move by sliding, falling, or rolling.

Blocks, special brackets, or special stands, such as those commonly used under raised vehicles, must be available at all times. Another form of blocking is the placement of a blind. A blind is a disk of metal placed in a pipe to ensure that no air or other substance will pass through that point if the system is accidentally activated.

Before installing blinds or blocks, bleed down steam, air or hydraulic lines to get rid of any pressure. Coiled springs, spring loaded devices or suspended loads must also be released so that their stored energy will not result in inadvertent movement.



Specifications

Model	T2030	T2440	T2850
Holding Capacity (bu)	470 bu	560 bu	650 bu
Grain Column Thickness	12"	12"	12"
Grain Column Length	20'-0"	24'-0"	28'-0"
Overall Length	30'-6"	34'-6"	38'-6"
Overall Width	7'-5"	7'-5"	7'-5"
Burner Capacity (All Heat)	approx 7.1 MMBTU/hr	approx 7.7 MMBTU/hr	approx 8.9 MMBTU/hr
Burner Capacity (Heat +Press+Cool)	approx 3.8 MMBTU/hr	approx 4.4 MMBTU/hr	approx 5.3 MMBTU/hr
Burner Capacity (Heat+Vac+Cool)	approx 3.0 MMBTU/hr	approx 3.5 MMBTU/hr	approx 4.2 MMBTU/hr
Fan Motor Size	30 HP	40 HP	50 HP
Unload Auger Motor Size	1.5 HP	1.5 HP	1.5 HP

T2030 Dimensions

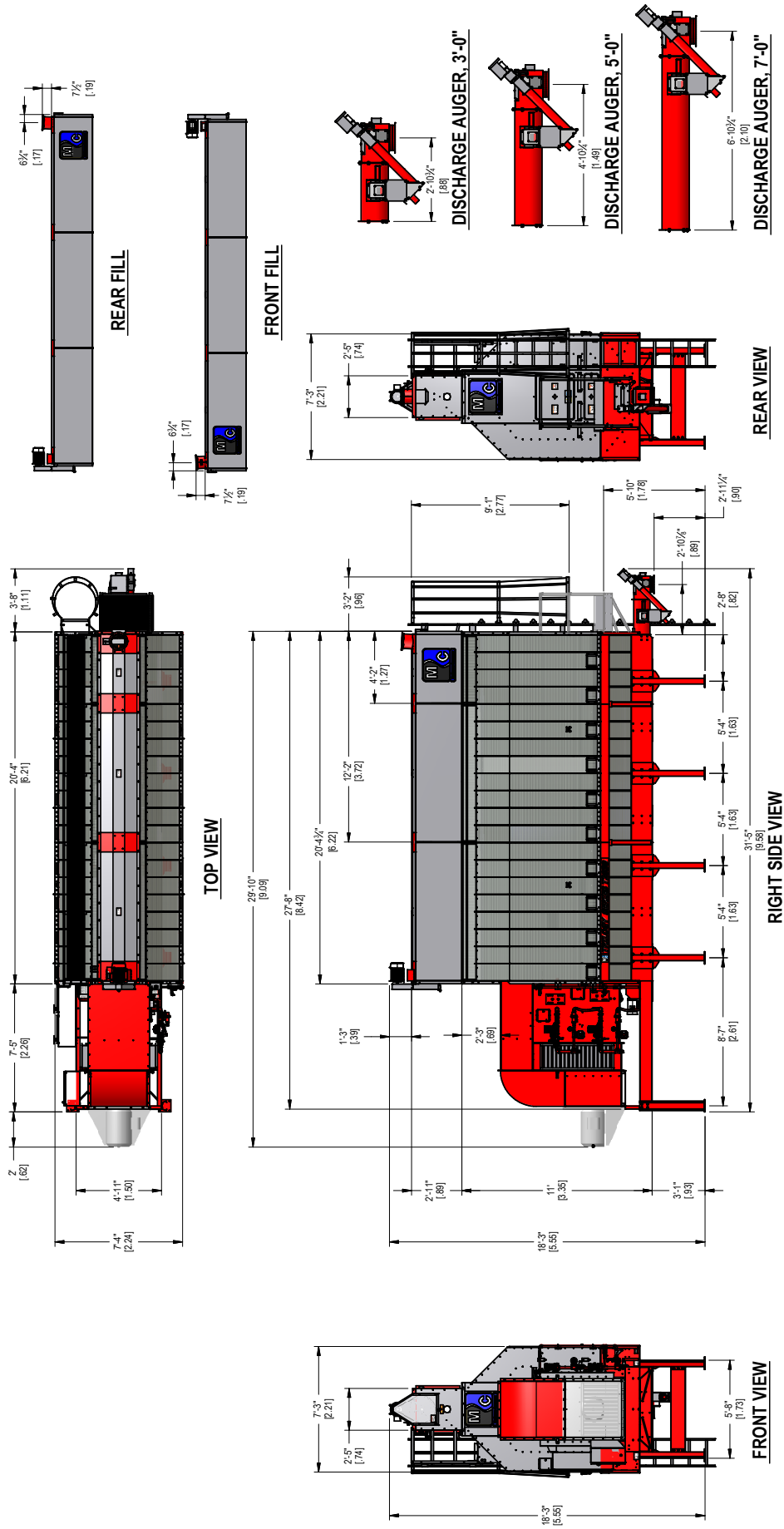

T2440 Dimensions

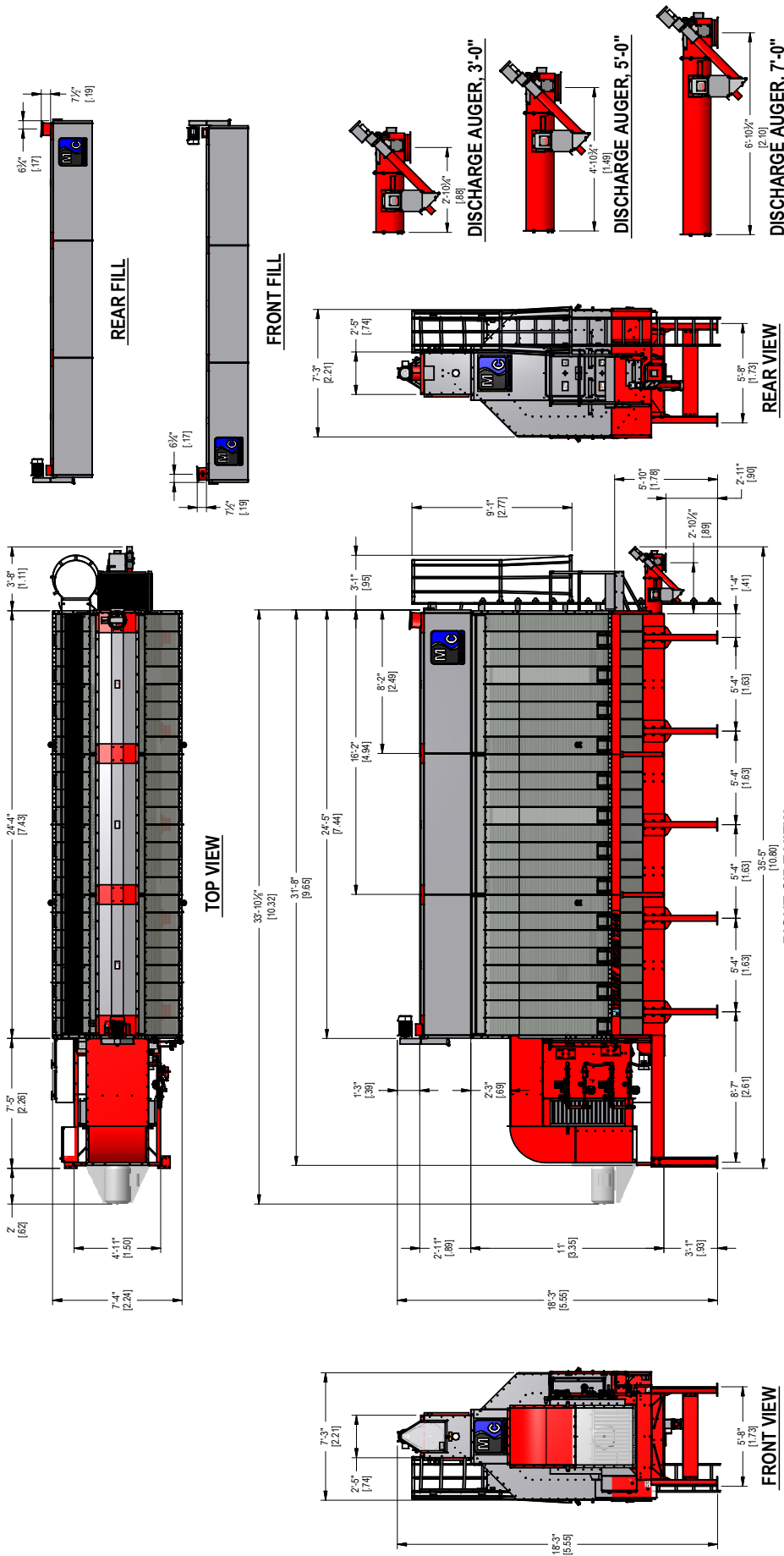

T2850 Dimensions

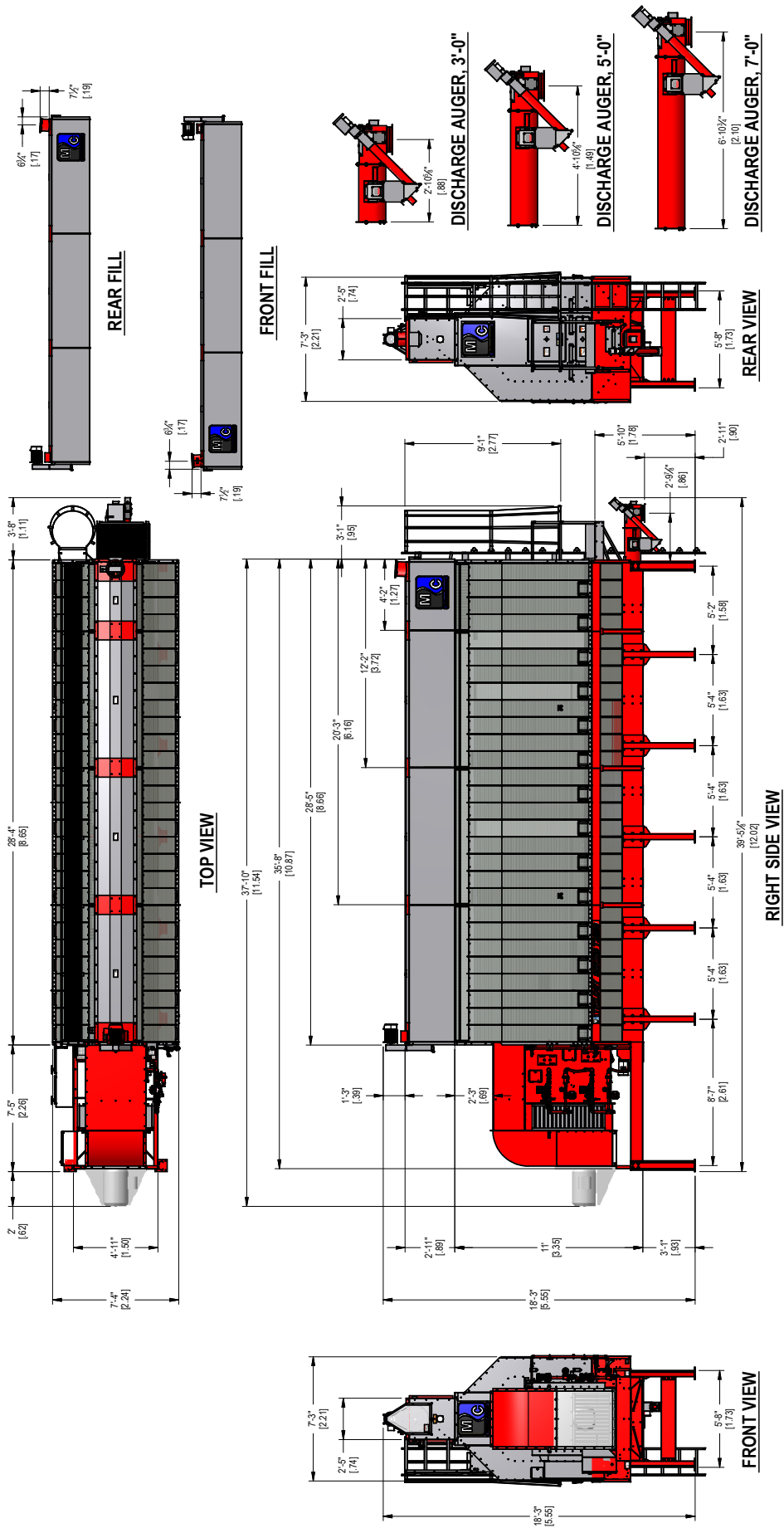

Equipment Overview

The Equipment Overview section will help identify parts of the dryer and briefly explain their function. The images will physically show you what the component(s) look like and the description following will state their purpose.

Main Dryer Components

The following rendered image shows an overall view of the dryer with some of the main components highlighted. The pages following will explain these components or assemblies more in depth as well as explain the function of any associated parts.

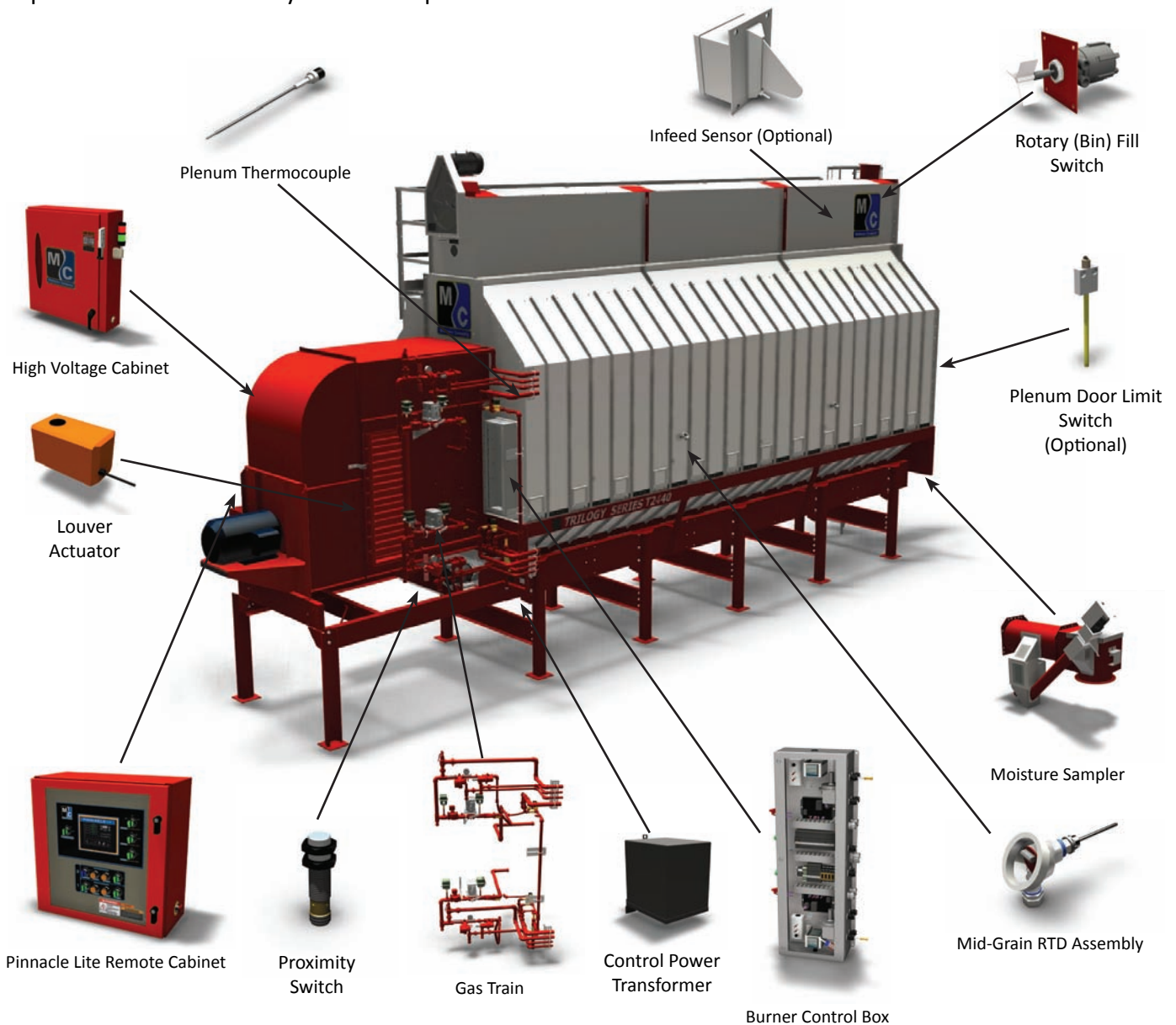



Rotary (Bin) Fill Switch

The Rotary Fill Switch is located in the wet hopper on the opposite end of the fill tube and is powered by 120V. The switch is motorized and will rotate a paddle until wet grain comes in contact with the paddle. Once this happens, grain stops the rotation and proves the level of grain in the hopper.



Plenum Thermocouple

The Plenum Thermocouple is a temperature sensing device located in the plenum used to send a signal to the temperature controller to establish and maintain plenum temperature.



Mid-Grain RTD Assembly

The four Mid-Grain RTD (Resistance Temperature Device) Assemblies are located around the perimeter of the dryer and are used to detect the temperature of the grain in the column. Each of these four RTD assemblies is equipped with a 4-20mA transmitter which provides an analog input signal sent to the PLC.



Proximity Switch

The Proximity Switch is used to detect the rotation of the discharge metering system by sensing the proximity of a detector on the discharge metering shaft. If the rotation of the shaft goes undetected for a set duration of time, the machine will be shutdown.



Control Power Transformer

The Control Power Transformer is used to transform a portion of the incoming electrical power to reliable 120V control power which is used to supply power to various electrical components including the PLC.



Louver Actuator

The Louver Actuator is used to modulate the automatic louvers inside the fan chamber. These louvers will move depending on the type of mode that you are in.



Infeed DM510 Moisture Sensor (Optional)

The infeed moisture sensor is mandatory for AccuDry grain dryers, and optional for TruDry grain dryers. This sensor monitors incoming grain in real-time so that the AccuDry prediction model can react to incoming grain moisture changes. On an optional TruDry grain dryer, this will only display on the main screen, and will not affect the operation of the grain dryer.

High Voltage Cabinet

The High Voltage Cabinet contains all of the motor starters and protectors, main power disconnect, programmable logic controller (PLC), breakers, relays, and other associated electrical hardware.

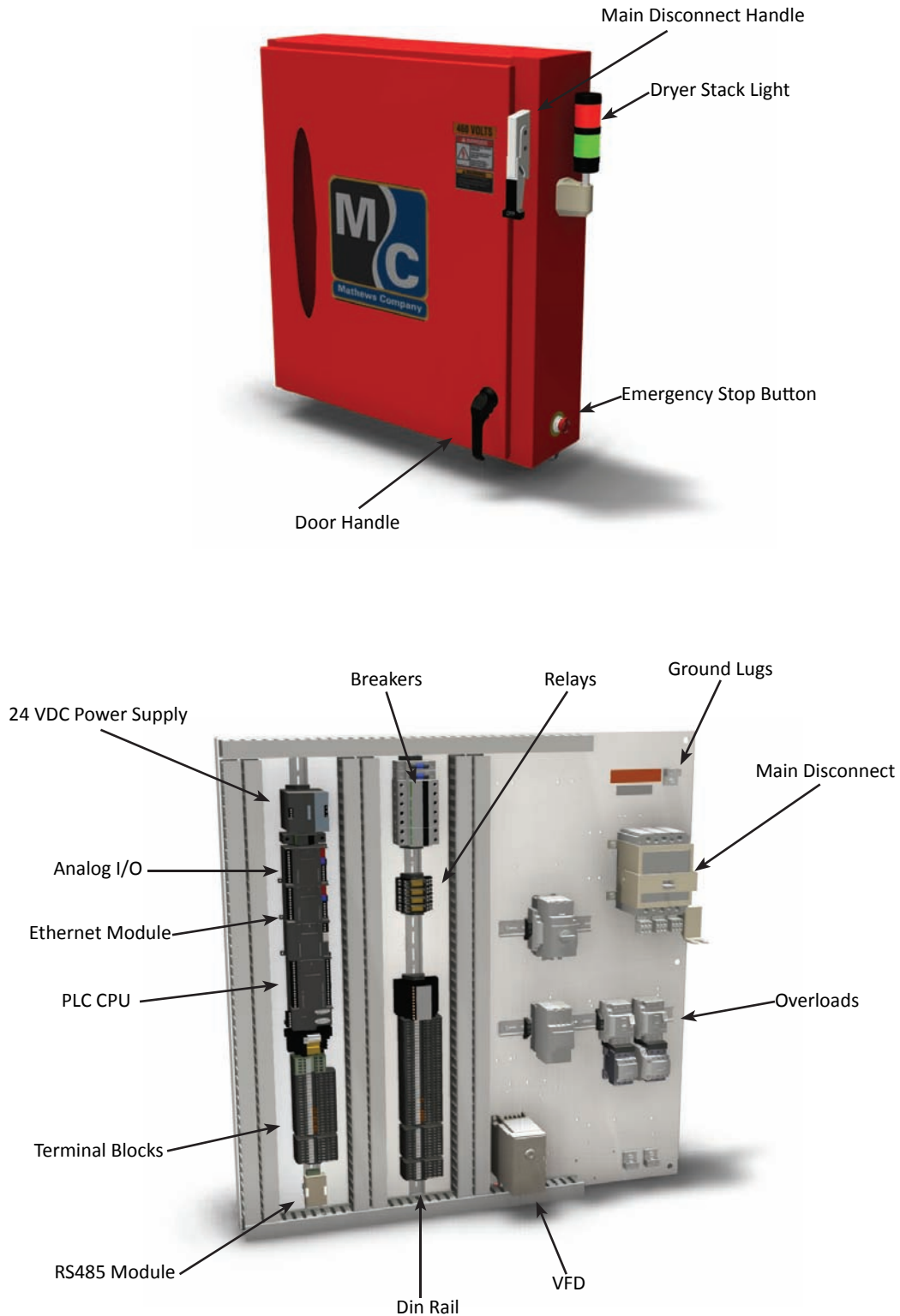

Pinnacle Lite Remote Cabinet

The Pinnacle Lite Remote Cabinet is where all of the dryer controls are located including the Pinnacle Lite HMI touch screen, power switches and indicator lights, as well as fan, burner, fill and discharge controls.

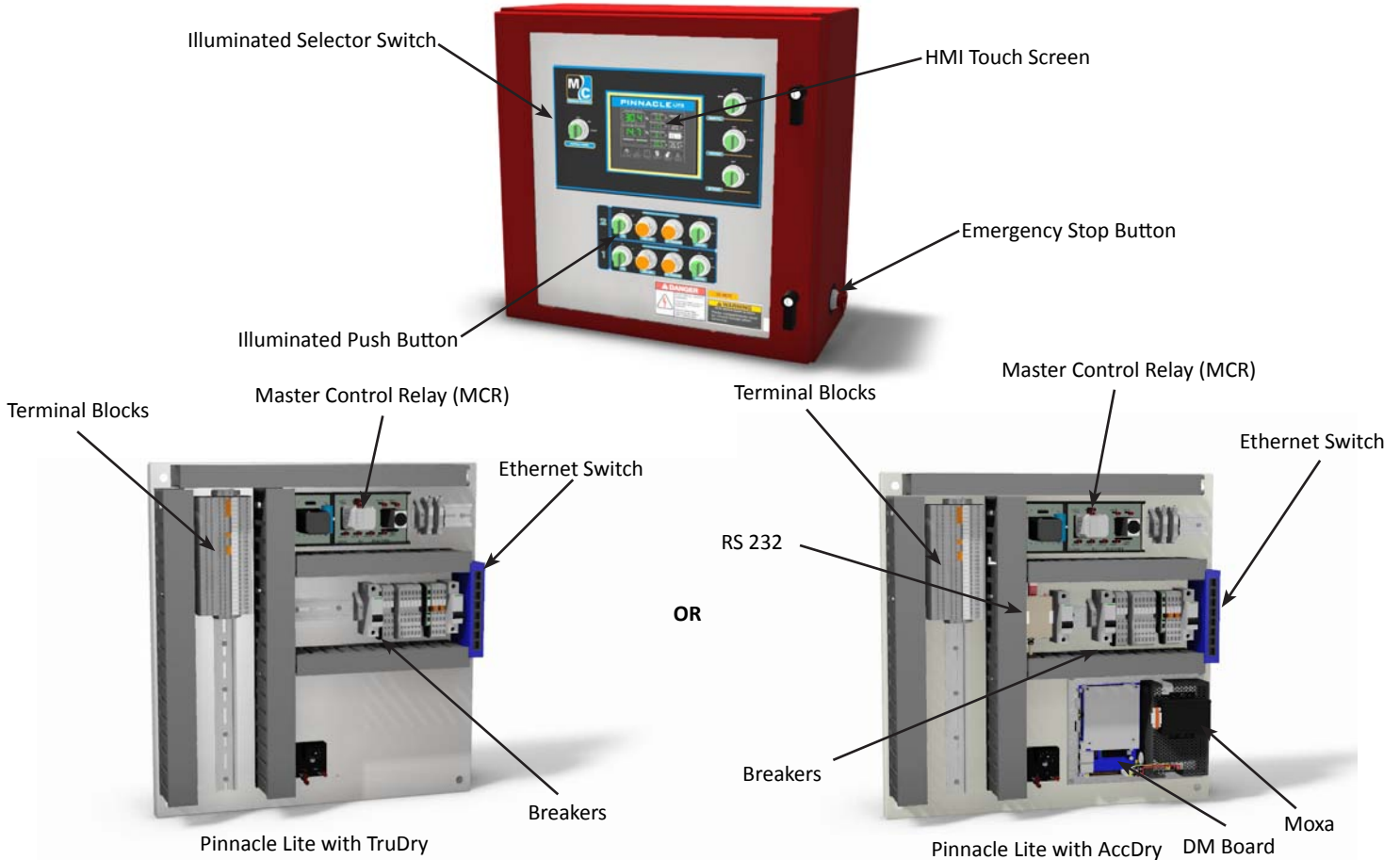

Illuminated Push Button



The amber colored Illuminated Push Buttons are a combination push button and indicator light device which individually indicate the status of the air pressure and high limit switches associated with its respective fan and burner. These push buttons also serve an additional purpose which is to reset the associated plenum's temperature controller mounted in the burner control box. Pressing both of the push buttons simultaneously will reset the temperature controller by cycling the power.

Illuminated Selector Switch



Illuminated Selector Switches are a combination selector switch and indicator light device which is used to start/stop devices and also indicate that the associated devices are in operation when looking at the remote cabinet from a distance.

Illuminated Mode Selector Switch



Illuminated Mode Selector Switch is a switch that is used for selecting the mode of operation. You can select from Pressure or Vacuum mode.



Human Machine Interface (HMI) Touch Screen

The HMI Touch Screen is where all Pinnacle Lite controls and related information is displayed. See the Pinnacle Lite Controls Manual for more information.

Burner Control Cabinet

The Burner Control Cabinet houses all of the components to safely operate the fan and burner which includes air pressure switches, high limit switches, ignition boards, and temperature controllers. The cabinet is mounted near the fan and burner for ease of access and/or troubleshooting purposes. This cabinet has a see through door so that the components, including the plenum temperature controllers, can be monitored without opening the door. Additionally, the plenum temperature setpoint can be adjusted locally on the temperature controller or remotely on the Pinnacle Lite HMI touchscreen.

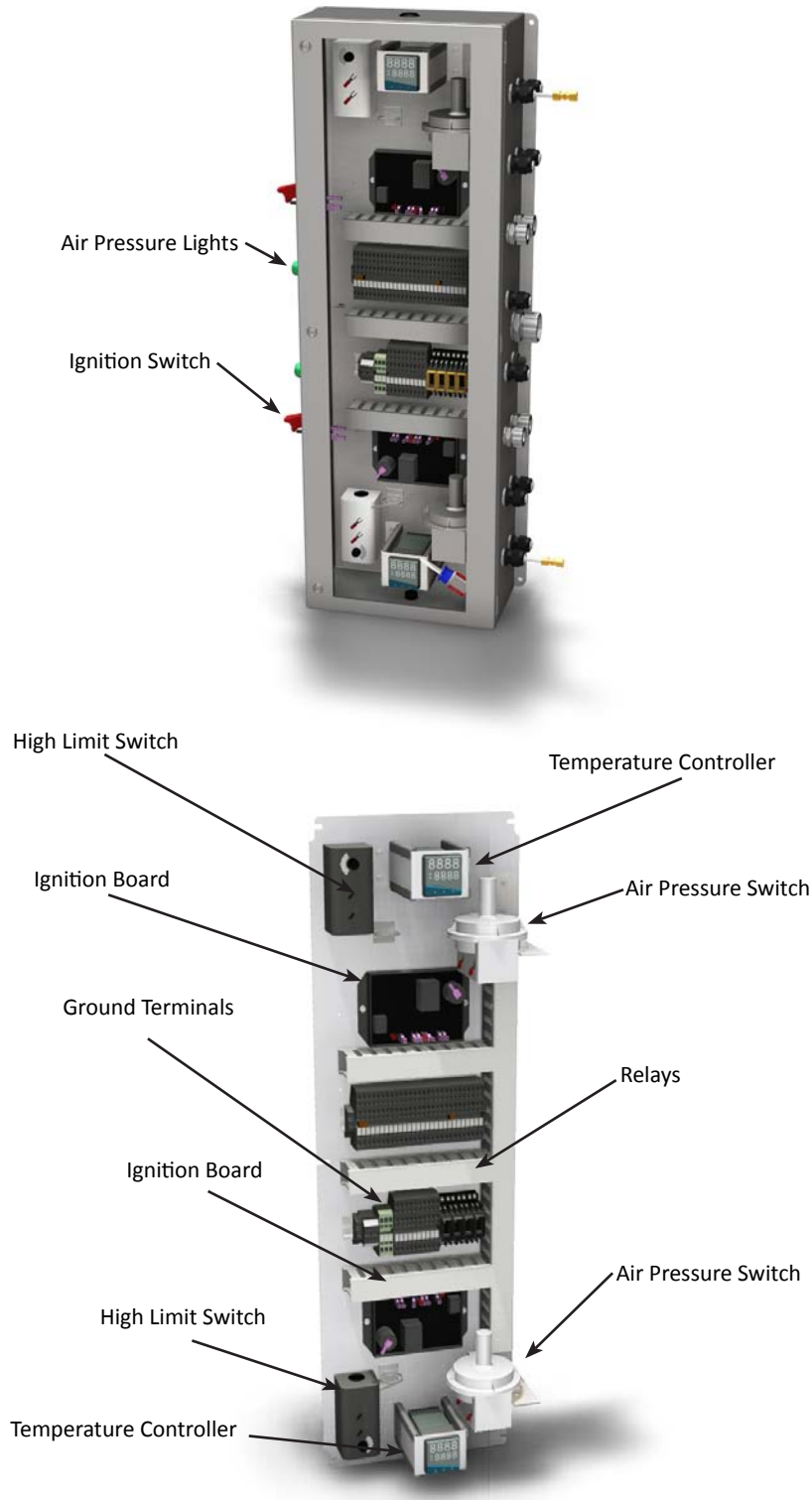



Ignition Board

The Ignition Board controls the overall operation of the burner by supplying high voltage from the coil to the spark plug to ignite the burner, sending signals to open/close the gas valves, and continuously monitoring the presence of a flame for safe and reliable operation.



High Limit Switch

The High Limit Switch utilizes a capillary bulb to sense an over-temperature condition in the plenum which will cause the dryer to shutdown. The high limit setpoint is adjustable on the switch and should be set approximately 40 deg F higher than the plenum temperature setpoint.



Air Pressure Switch

The purpose of the Air Pressure Switch is to prove airflow from the fan for safe operation of the burner. The air pressure switch is adjustable and should be set once the dryer is full of grain. Adjustment of the switch is done in the burner control cabinet and indication of reaching the air pressure switch's setpoint is indicated on the green light on the outside of the burner control cabinet as well as the amber light on the remote cabinet.



Temperature Controller

The Temperature Controller controls the plenum temperature by continuously adjusting the position of the gas control valve and in doing so displays both the setpoint and the actual temperature in the plenum which is measured by the plenum thermocouple. Additionally, the plenum temperature setpoint, actual plenum temperature, and the controller output % can be viewed on the Pinnacle Lite HMI touch screen.

Discharge Moisture Sampler

The discharge moisture sampler is used to continuously collect a sample of grain, move it past the discharge moisture sensor in a controlled and steady fashion, and return the sampled grain back to the discharge of the dryer.

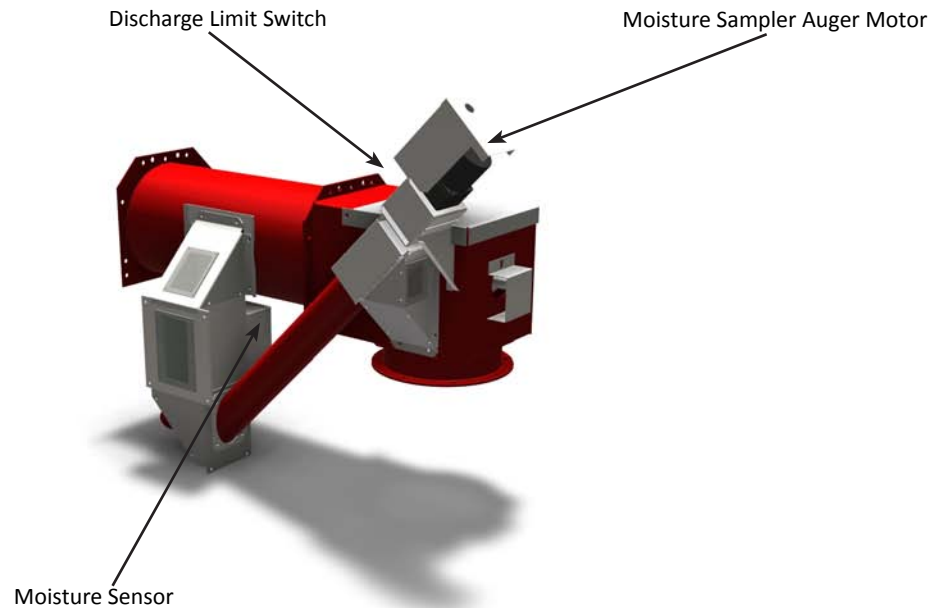

Moisture Sensor



The Moisture Sensor is an electronic device that measures the grain moisture indirectly by measuring the capacitance of the field of grain and correlating it to a voltage. Additionally, there is a small thermistor, which also produces an analog output voltage, mounted on the face of the sensor to measure the grain's temperature to compensate the moisture reading and to provide a real-time indication of the grain's temperatures. These voltages are input to the PLC and when calibrated, will display the discharge grain moisture as well as the temperature on the HMI touchscreen.

Discharge Limit Switch



The Discharge Limit Switch is a spring loaded lever that maintains a normally open contact which is held closed. The purpose of this switch is to detect a discharge grain overload condition that may be a result of a failed discharge auger or takeaway equipment. Once an overload conditions exists, the top door on the discharge auger will lift up and the switch will return to its normally open position; in doing so, the safety circuit is opened and the dryer is shutdown.

Moisture Sampler Auger Motor



The Moisture Sampler Auger Motor is a small fractional HP motor that slowly augers a sample of grain past the moisture sensor and returns the sampled grain back to the primary discharge of the dryer.



Gas Train

The purpose of the gas train is to safely and efficiently supply fuel at the correct pressures and flow rates to the burners. There are several variations of the gas train depending on what model and options are equipped on the machine.

If the dryer is equipped for LPG fuel, there will be liquid lines sending LPG to the vaporizer and back to the manifold. CE equipped machines will have gas pressure switches to meet local codes. CGA equipped machines will have gas pressure switches as well as liquid and vapor venting to meet local codes.

LPG Gas Train (Optional CGA Requirements)

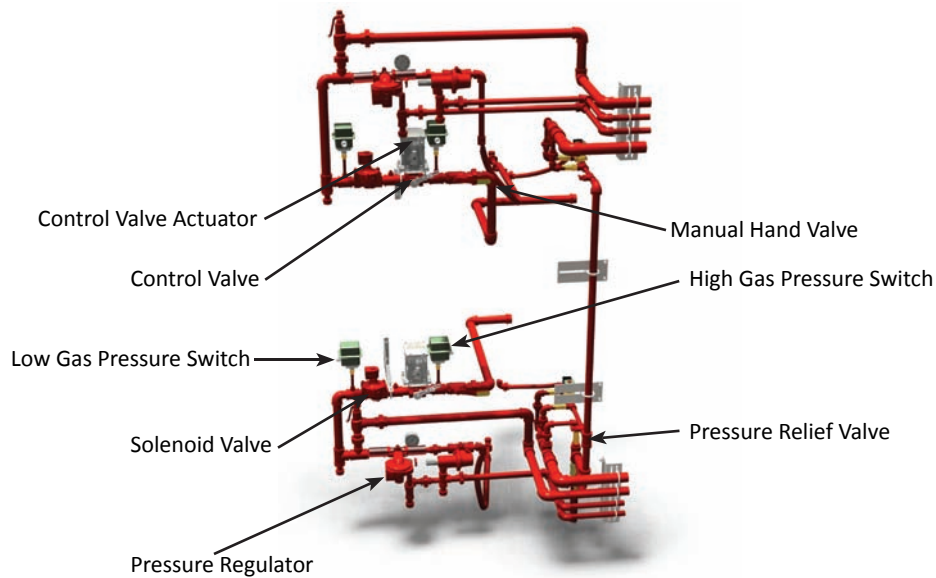



Control Valve

The Control Valve is a throttling butterfly valve that controls the fuel flow rate to the burner which is precisely positioned by the control valve actuator. The control valve is connected to the control valve actuator through a mechanical linkage.



Control Valve Actuator

The Control Valve Actuator is an electrical actuator that is connected to the control valve through a mechanical linkage that precisely positions it based on the output of the digital temperature controller. As the plenum temperature drops below the setpoint, the temperature controller tells the control valve actuator to open more, whereas if the plenum temperature rises above the setpoint, the temperature controller tells the control valve actuator to close more.



Strainer

The purpose of the Strainer is to collect any foreign material with a wire mesh filter that may find its way into the fuel supply line.



Solenoid Valve

The Solenoid Valve is to start and stop the flow of fuel to the burner. The opening/closing actuation of the solenoid valve is monitored and performed by the ignition board.



Pressure Relief Valve

The purpose of the Pressure Relief Valve is to automatically open and relieve excess pressure when the line pressure becomes too high. Once the pressure drops, the valve will close and seal again for continued proper operation.



Low / High Gas Pressure Switches (CE/CGA equipped machines only)

The Low / High Gas Pressure Switches are adjustable switches used to detect either low gas or high gas pressure in the gas train and shutdown the dryer. These switches are used for CE or CGA equipped machines to meet local codes.



Pressure Regulator

The Primary purpose of a Pressure Regulator is to continuously control the supply pressure of the fuel to the gas train manifold. There are various sizes and configuration based on model and configured options, however the primary purpose is the same.



Manual Hand Valve

The purpose of a Manual Hand Valve is to manually open and close various portion of the gas train for maintenance purposes.



Burner

The purpose of the burner is to provide heat to the drying air. This heat come from the combustion of the supplied fuel and takes place in the Maxon NP burner.

Maxon NP Burner

The Maxon NP Burner, which consists of a cast iron burner body drilled to discharge gaseous fuel between diverging stainless steel mixing plates, is a burner which efficiently combusts the fuel/air mixture thereby producing the required process heat to the drying air.

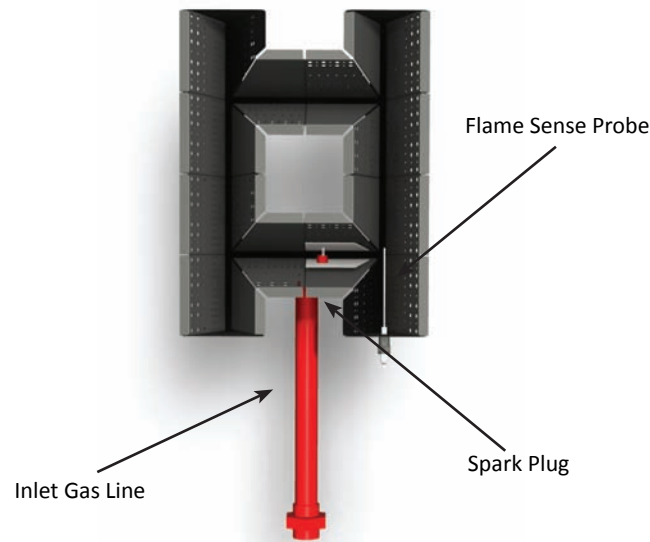

Spark Plug

The Spark Plug receives high voltage current from the ignition board and arcs at the spark plug gap to provide direct spark ignition for the burner.



Flame Sense Probe

The Flame Sense Probe detects the presence of the flame and provides positive confirmation to the ignition board so that operation of the burner may continue.

Operating Procedures

Overview

This section will explain the operation of the primary components of the dryer as well as provide step-by-step procedures to properly start-up and shut-down the machine. Operational and functional descriptions along with adjustment details for primary components will be presented initially, followed by operational procedures for starting up and shutting down the dryer.

Component Adjustments

The following information will provide you with the details you need to properly operate the different components of the dryer and to make any adjustments necessary. The components listed in the pages following do not comprise everything that can be adjusted on the dryer, but rather the components that need to be adjusted based on normal operation.

Air Pressure Switch

The purpose of the Air Pressure Switch is to prove airflow from the fan for safe operation of the burner. Once the pressure switch has been satisfied, operation of the burner and its ignition system are permitted. In the event that air pressure is lost as indicated by a non-illuminated air pressure light, the burner will extinguish.

Depending on the number of burners, this will determine the number of air pressure switches, with one installed per burner. The air pressure switch is adjustable and should be set once the dryer is full of grain. Adjustment of the switch is done in the burner control cabinet and indication of reaching the air pressure switch's setpoint is indicated by the green air pressure light on the outside of the burner control cabinet as well as the amber air pressure light on the remote cabinet.

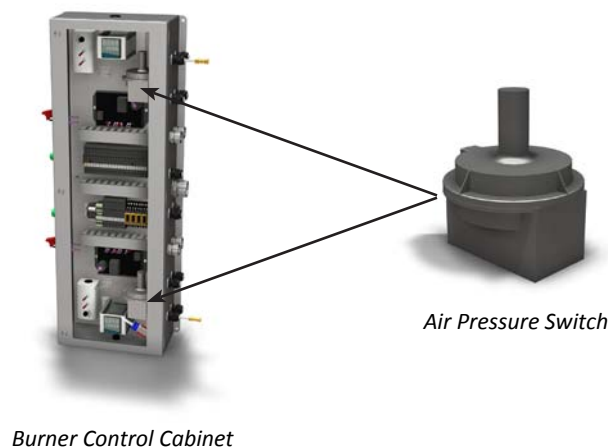

The safety features associated with the air pressure switch(es) are for your safety and for the protection of the dryer. They should be checked for correct operation at the start of the drying season and periodically during the season as they are designed to protect the dryer from a fire that may result from fan (air flow) failure while the burner is ignited and a flame is present.



Setpoint Check

The following procedure shall be utilized to properly check the air pressure switch(es) setpoint. Note that the air pressure switch for each fan/burner must be checked and set independently.

1. After the dryer has been filled with grain and before the burner is ignited, the operation of each air pressure switch must be checked.
2. All of the fans must be running (including the cooling fans) before the air pressure switches can be accurately adjusted.
3. Start all fans and determine if the air pressure switch light (for the switch that is being verified) on the remote cabinet or the burner control cabinet illuminates once the respective fan has reached its normal operating speed.
4. If the indicator light does not illuminate or comes on too soon (before the fan reaches operating speed), the air pressure switch must be adjusted.

Switch Adjustment

In the event that the indicator light does not illuminate or comes on too soon (before the fan reaches operating speed), the following procedure shall be used to properly set the air pressure switch:

1. Remove the cap on the air pressure switch. Inside the air pressure switch use the slotted screw to make adjustments by turning clockwise or counter-clockwise.
2. Turn the adjusting screw counter-clockwise until the air pressure light comes on. After the air pressure light comes on, turn the adjusting screw counter-clockwise an additional $\frac{1}{4}$ to $\frac{1}{2}$ turn to allow for normal changes in static pressure.

The air pressure light will go out when the fan is turned off because the fan start/stop illuminated switch is wired so that the power flows from the fan start/stop illuminated switch to the air pressure indicator light on the remote cabinet and the burner control cabinet.

If all air pressure switch adjustment is used and the air pressure light does not illuminate, the air pressure switch is defective and must be replaced. Once the switch is replaced, check its operation and make adjustments as previously outlined.

High Limit Switch

The purpose of the High Limit Switch is to provide a safety shutdown in the event that the temperature in any of the plenums has exceeded the high limit setpoint. The high limit switch senses the temperature in the plenum that it is monitoring by means of a capillary bulb temperature sensing device.

Depending on the number of burners, this will determine the number of high limit switches, with one installed per burner. The high limit switch is adjustable and should be set once at the start of a drying season or for a given grain. Adjustment of the switch is done in the burner control cabinet and indication is provided by the amber high limit light on the remote cabinet. The light will normally be illuminated if a high limit condition has not been met. Note that when a high limit setpoint is exceeded, the high limit light for the applicable fan/burner will become non-illuminated as well as all other high limit lights above it because the wiring of the switch/lights are in series. For example on a 2-fan/burner system, if high limit in plenum #1 is exceeded, the high limit for plenum 1 and 2 will no longer be illuminated.

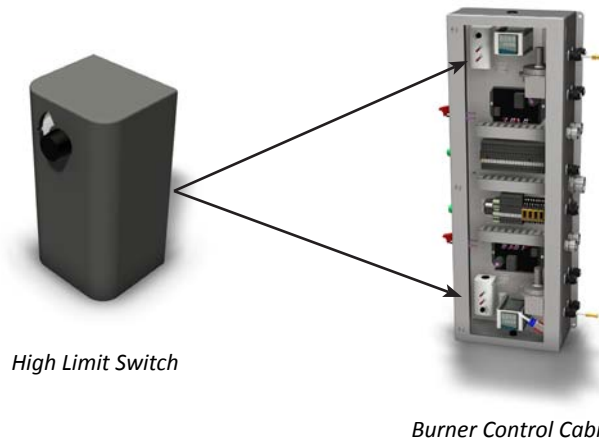

High Limit Switch

Burner Control Cabinet



The safety features associated with the high limit switch(es) are for your safety and for the protection of the dryer. They should be checked for correct operation at the start of the drying season and periodically during the season as they are designed to protect the dryer from a fire that may result from fan (air flow) failure while the burner is ignited and a flame is present.

Setpoint Check and Switch Adjustment

The following procedure shall be utilized to properly check the high limit switch(es) setpoint. Note that the high limit switch for each fan/burner must be checked and set independently. Once the high limit setpoint has been reached, the switch will need to be reset by pressing the small reset button on the top of the device.

After the dryer has been filled with grain and after the burner is ignited, the operation of each high limit switch must be checked.

1. Start the fan, ignite the burner and establish a stable temperature in the plenum.
2. Inside the burner control cabinet, adjust the high limit switch setpoint by turning the small dial counter-clockwise to a temperature below the current temperature in the plenum.
3. Once the high limit switch determines that the temperature in the plenum has exceeded the high limit setpoint, the switch will cause the dryer to shutdown and turn off the respective plenum's high limit light on the remote cabinet.
4. If the high limit switch does not shut down the dryer, it is defective and must be replaced. Once the switch is replaced, check its operation and make adjustments as previously outlined.
5. If the setpoint is exceed and properly shuts down the dryer, the setpoint can be adjusted to a value that is approximately 40 deg F above the desired plenum temperature.



Grain Fill System

The dryer control system features both a manual and an automatic grain filling system. To properly fill the dryer and to measure the grain level, the dryer is equipped with a leveling auger as well as a rotary (bin) level switch and two timers (grain flow timer and fill delay timer) located in the Remote Cabinet. Additionally, there is a green illuminated toggle switch with positions "AUTO", "MAN", and "OFF" on the Remote Cabinet. The following modes of grain fill operation are explained:

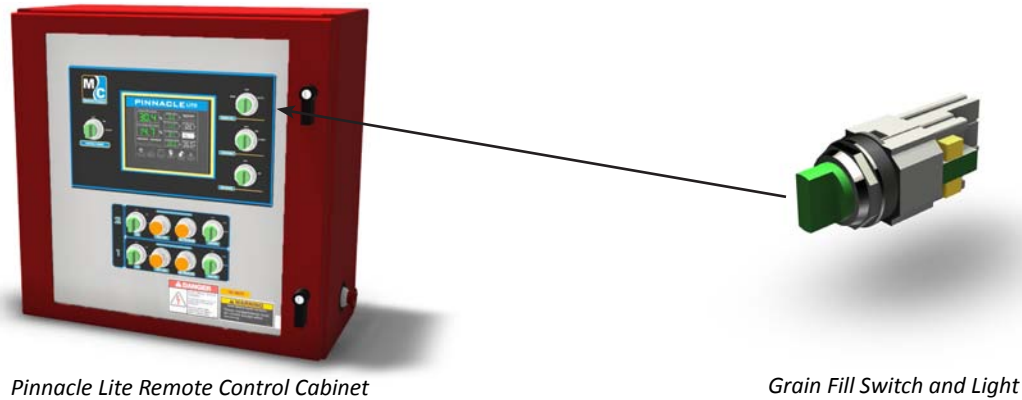

Pinnacle Lite Remote Control Cabinet

Grain Fill Switch and Light

OFF

When the grain fill switch is in the OFF position, the level auger will not run. Additionally, the status of the grain flow timer, fill delay timer and the rotary (bin) level switch will not be monitored.



Do not allow anyone to be in the dryer when filling it with grain. Always turn off and lock-out the electrical power supply to the High Voltage Cabinet before allowing anyone to work in the dryer.

MAN

When the grain fill switch is in the MAN position, the grain fill system is setup to run manually. Setting the grain fill system to run manually means that the grain flow timer and the fill delay timer are not monitored and the level auger and the rotary (bin) level switch are the only components being utilized to fill the dryer.

Running the grain fill system manually means that as the rotary (bin) level switch does not sense grain level (the paddle is rotating), the level auger will run, your fill equipment will deliver grain to the dryer and the grain fill switch will illuminate. Once the rotary (bin) level switch senses grain level (the paddle is no longer rotating), the level auger will stop running, your fill equipment will no longer be commanded to operate and the grain fill switch will no longer be illuminated. As the dryer discharges grain and the level in the hopper begins to drop, the rotary (bin) level switch will no longer sense grain level (the paddle will start rotating again), the level auger and your fill equipment will start running again as well as illuminating the grain fill switch. This process will continuously operate cycling the level auger and your fill equipment on/off repeatedly because while running the grain fill system is in manual mode, the grain flow timer and the fill delay timer are not used; this is not a recommended way to operate the dryer. Instead, fill your dryer for the first time in manual mode and switch it to automatic once you are ready to begin continuous flow operation.

AUTO

When the grain fill switch is in the AUTO position, the grain fill system is setup to run automatically. Setting the grain fill system to run automatically means that the grain flow timer and the fill delay timer are used in conjunction with the level auger and the rotary (bin) level switch to fill the dryer.

Running the grain fill system automatically means that as the rotary (bin) level switch does not sense grain level (the paddle is rotating) after the grain fill delay timer has elapsed, the level auger will run, your fill equipment will deliver grain to the dryer and the grain fill switch will illuminate. Once the rotary (bin) level switch senses grain level (the paddle is no longer rotating), the level auger will stop running, your fill equipment will no longer be commanded to operate and the grain fill switch will no longer be illuminated. Once the level auger and your fill equipment stop running, both the fill delay timer and the grain flow timer will start. The fill delay timer sets the time delay duration between when the rotary (bin) level switch senses grain level (the paddle is no longer rotating) and when the level auger and your fill equipment will begin running again. Similarly, the grain flow timer begins to countdown once the rotary (bin) level switch senses grain level (the paddle is no longer rotating), however the grain flow timer is used to detect when the fill equipment is no longer able to provide grain to the dryer. If after the level auger and your fill equipment stop running, the grain flow timer duration has been reached without the rotary (bin) level switch sensing grain level (the paddle is no longer rotating), the system will have encountered a grain flow fault and the dryer will be shutdown.

Setting the Timers

Both the fill delay and the grain flow timers are located in the Remote Cabinet. The following explains the procedure for properly setting up your grain fill system. Note that turning the grain fill switch to OFF and back to AUTO will reset the fill delay and grain flow timers.

1. Set the fill delay timer for the desired time, which is recommended to be 1-2 minutes (60-120 sec). To set the timer, simply turn the dial clockwise or counter-clockwise as necessary.
2. Set the grain flow timer for the desired time, which is recommended to be 5-10 minutes. To set the timer, set the arrows at the bottom of the timer face to X10 (times ten) and to M (minutes). It may be necessary to remove the timer from its socket to make this adjustment. Now turn the timer control knob to 1 (1x10) or 10 minutes.
3. Check the refill time a minimum of six times and calculate the average refill time. Once the average grain refill time has been determined, set the grain flow timer equal to the average refill time plus 5 minutes. This will ensure that the dryer will not shutdown unless the average grain refill time has passed and an additional 5 minutes has elapsed without the grain level being reached.

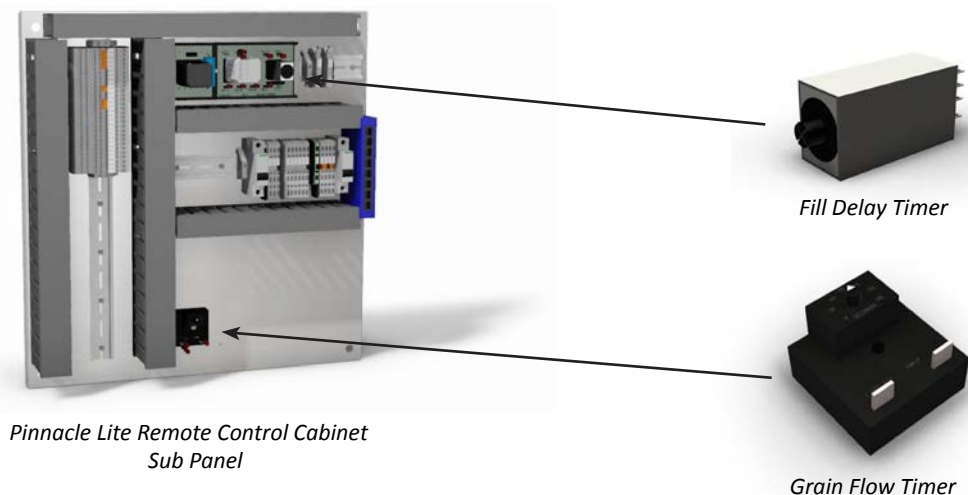

Temperature Controller

The purpose of the temperature controller is to control the plenum temperature by adjusting the position of the fuel control valve by means of the control valve actuator. Depending on the number of burners, this will determine the number of temperature controllers, with one installed per burner.

The temperature controller is located in the Burner Control Cabinet and displays the actual and set point temperature as well as indication of controller output and alarms. Additionally, the temperature controllers are in continuous communication with the Pinnacle Lite control system and the actual temperature and setpoint temperature, as well as other parameters, can be viewed on the HMI touchscreen in the Plenums chapter.

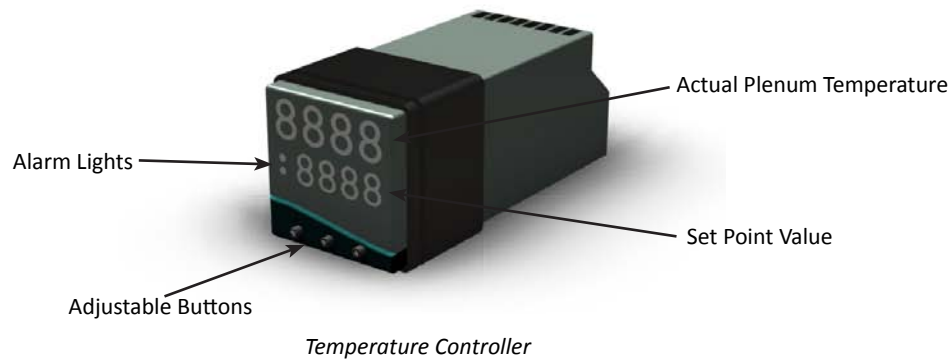

Programs

The temperature controller is pre-programmed from the Mathews Company facility with one of six different programs: Tower, Tower (metric), Profile, Profile (metric), Fuel Oil, and Fuel Oil (metric). The program that is loaded on the controller establishes parameters that are specific to the type of machine the controller is installed on and determines the units of display (degrees Celsius or degrees Fahrenheit). There are several parameters that are adjustable on the controller, however most of them are unused and the default values are left un-altered. The parameters that are changed from the default values when the controllers are initially loaded with one of the six standard controller programs are shown in the table that follows. These parameters should not ever need to be changed, however in the event that parameter adjustments are needed as directed by M-C service personnel, refer to the procedure in the Adjustments section to make program changes.

Parameter Name	Display Name	Function Level	Program		
			Default Values	Profile	Profile (Metric)
Device	inPt	5	nonE	tCK	
Units	unit	5	nonE	F	C
Low Limit	Lo.SC	2	32	0	
High Limit	hi.SC	2	caries	240	116
Proportional	bAnd	1	18	75	24
Integral	int.t	1	5.0	1.5	
Derivative	der.T	1	25	0	
Cycle Time	CYC.t	1	20	0.1	
Output 1 Type	SP1.d	5	nonE	Analog	
Output 2 Mode	SP2.A	2	nonE	dev Hi	
Output 2 Option	SP2.b	2	nonE	Latch	
Output 2 Setting	SEt.2	1	0	40	23
Output 2 Band	bnd.2	1	3.9	5.0	2.0
Output 3 Mode	SP3.A	A	nonE	dev Lo	
Output 3 Option	SP3.b	A	nonE	Hold	
Output 3 Setting	SEt.3	A	0	-40	-23
Address	Addr	C	0	varies**	
Baud Rate	bAud	C	9600	19.2	

**Note: The address number will correspond to the burner number on the machine, i.e. 1-2



Adjustments

All parameters for the temperature controller can be adjusted when it is powered up and operational. While the controller is in the main operating mode, the display will show two numbers; the top number is the actual temperature detected by the thermocouple in the plenum, whereas the bottom number shows the current temperature setpoint.

To make adjustments to the temperature setpoint, follow the procedure as follows:

1. Press * and ▼ to lower the temperature setpoint.
2. Press * and ▲ to raise the temperature setpoint.

To make parameter adjustments, follow the procedure as follows:

1. Hold down ▲ and ▼ simultaneously for 3 seconds.
2. Press ▲ or ▼ separately to page through parameters.
3. When LEVL is displayed, press * and ▼ or * and ▲ to change level.
4. Press ▲ or ▼ to page through the parameters for that level.
5. Press * and ▼ or * and ▲ to change a parameter.

To reset the controller in an alarm condition, follow the procedure as follows:

1. Make sure the condition causing either the low temperature or high temperature alarm has been rectified.
2. Momentarily press ▲ and ▼ simultaneously for 3 seconds.

To automatically tune the PID loop of the controller, follow the procedure as follows:

1. Press ▲ and ▼ simultaneously for 3 seconds.
2. Press ▼ or ▲ until TUNE is displayed.
3. Press the * and ▼ or * and ▲ until At.SP is displayed.
4. Press ▲ and ▼ simultaneously for 3 seconds.
5. You are now auto-tuning. Once TUNE disappears, auto-tuning is complete.
6. To abort auto-tune, press ▲ and ▼ simultaneously for 3 seconds.
7. Press ▼ or ▲ until the word TUNE is displayed.
8. Press the * and ▼ or * and ▲ until oFF is displayed.
9. Press ▲ and ▼ simultaneously for 3 seconds.
10. Auto-tuning is now disabled.

Alarms

The temperature controller not only controls the temperature in the plenum, but it also provide low temperature and high temperature alarms. When the plenum temperature drops below the low temperature setpoint or rises above the high temperature setpoint, an alarm condition will occur. The low and high temperature setpoint parameters are established in the program loaded on the controller as explained in the Programs section. If the low or high temperature alarms occur while the burner is lit, the controller will shutdown the dryer and a Type "C" alarm will be displayed on the Pinnacle Lite HMI touchscreen which is further explained in the Pinnacle Lite Controls Manual. Similarly, if the low or high temperature alarms occur while the burner is not lit, no action is taken, however the Pinnacle Lite HMI touchscreen will display a Type "A" alarm.

Once an alarm condition occurs, the condition causing the alarm needs to be rectified then the controller can be reset as described in the Adjustments section. Similarly, you can also reset the controller on the Pinnacle Lite HMI touchscreen as explained in the Pinnacle Lite Controls Manual. As an alternative, the controller can also be reset by re-powering. This is accomplished by momentarily pressing the corresponding air pressure light button and the high limit button (on the Remote Control Cabinet) simultaneously.

Low temperature alarms are non-latching which means that once the low temperature condition has been rectified, the controller will automatically reset itself. High temperature alarms however are non-latching and not only will the condition causing the alarm need to be rectified, but the controller will need to be reset as previously described.

Normally the plenum temperature setpoint is substantially higher than the ambient temperature before the burner in the plenum is lit. For example, if the ambient temperature is 65 deg F and the plenum temperature setpoint is 220 deg F, this would normally be considered a low temperature alarm condition, however one of the features of the controller is that it inhibits the low temperature alarm during the initial burner ramp-up in the plenum. This means that you will not receive a low temperature alarm unless the temperature has gotten within the setpoint and dropped back down below the low temperature setpoint. This is a nice feature, however please note that although this low temperature alarm is inhibited on the first time the burner is lit, a burner shutdown/cooldown with a consecutive ramp back up will cause the low temperature alarm. In order to avoid this condition, it is required to re-cycle the power to the controller which is done by momentarily pressing the corresponding air pressure light button and the high limit button (on the Remote Control Cabinet) simultaneously.



Variable Frequency Drive (VFD)

The purpose of the variable frequency drive is to control the speed of the discharge metering rolls. The communication from the HMI to the PLC then correlates to the variable frequency drive.

Variable Frequency Drive Parameters

Level	Code	Description	M-C Setting
1st Time Power	bfr	Standard Motor Speed	60hz
	Fr1	Change to A1Va for Manual	AI1
ref-	LFr	HMI Frequency	0 to 500hz
	AIU1	Input	0 to 100%
	FrH	Frequency	LSP to HSP
SEt	ACC	Acceleration Tlme	5 Sec
	dEC	Deceleration Tlme	5 Sec
	LSP	Low Speed	5.0hz
	HSP	High Speed	60hz
	ItH	Motor Thermal Current	2.1
	UFr	IR Compensation	25
	FLG	Frequency Loop Grain	20
	StA	Frequency Loop Stability	20
	SLP	Slip Compensation	100
	tdC1	Auto DC Injection Tlme	0.5 s
	SdC1	Auto DC Injection Current	7.7
	tdC2	2nd Level DC Injection Time	0 s
	SdC2	2nd Level DC Injection Current	5.5
	JPF	Skip Frequency	0 hz
	JF2	2nd Skip Frequency	0 hz
	SP2	Speed Preset 2	10 hz
	SP3	Speed Preset 3	15 hz
	SP4	Speed Preset 4	20 hz
	CLi	Limiting Current	2.6
	tLS	Low Speed Operating Time	0 (disable)
	Ftd	Motor Frequency Threshold	60
	ttd	Motor Thermal Threshold	100
	Ctd	Motor Current Threshold	2.1
	SdS	Scale Factor for SPd1/2/3	30
	SFr	Switching Frequency	4 kHz
drC	bFr	Nominal Motor Voltage	230*
	FrS	Normal Motor Frequency	60
	nCr	Nominal Motor Current	2.6
	nSP	Nominal Motor Speed	1725
	COS	Motor Power Factor	0.88
	rSC	Cold State Stator Resist	nO
	tUn	Auto Tuning	N/A

	SSL	Suppress Speed Loop	nO
	SCS	Save Parameter Config	nO
	FCS	Restore Factory Settings	nO
I-O	tCC	Type Of Control	2C
	tCt	Type of 2 Wire Control	trn
	rrS	Reverse	nO
	CRL3	Current Input Low	4 ma
	CRH3	Current Input High	20 ma
	AOIt	Analog Output Config	IOU
	dO	Analog/Logic Output	OFr
	r1	Relay R1	FLt
	r2	Relay R2	nO
	SCS	Configuration Backup	nO
	FCS	Rest the Configuration	nO
FUn	StC-	Stop Control	N/A
	Stt	Normal Stop Type	nSt
SUP		Monitoring Parameter	FrH or LCr

Changing Variable Frequency Drive Parameters

Minimum Discharge Rate

1. Press the jog dial once and turn right one click until SEt is displayed.
2. Press the jog dial and turn right two clicks to display LSP.
3. Press the jog dial to display data. The data displayed is in units of hertz (Hz). The range is 0 to 60 Hz.
4. Rotate the dial to change the number. The higher the number the faster the discharge. Factory settings should be at 5 Hz.
5. Press and hold the jog dial till the value flashes to save.
6. Press "ESC" three times to return to rdY.

Maximum Discharge Rate

1. Press the jog dial once then turn to the right until SEt is displayed
2. Press the jog dial once, turn to the right three clicks to display HSP.
3. Press the jog dial once. The data displayed is in units of hertz (Hz). The range is 0 to 60 Hz.
4. Rotate the dial to change the number. The higher the number the faster the discharge. Factory settings should be at 60 Hz.
5. Press and hold the jog dial till the value flashes to save.
6. Press "ESC" three times to return to rdY.

Current Limit of Discharge Rate

1. Press the jog dial once then turn to the right until SEt is displayed
2. Press the jog dial once then turn to the right two click to display drC.
3. Press the jog dial once then turn to the right one click to display nCr. The data displayed is unit of AC amps.



4. Arrow down the menu until “nCr” appears. The data displayed is in units of AC amps.
5. Press and hold the jog dial till the value flashes to save.
6. Press “ESC” three times to return to rdY.

Acceleration for Discharge

1. Press the jog dial once and turn right one click until SEt is displayed.
2. Press the jog dial once till ACC is displayed.
3. Press the jog dial once to display data. The data that is displayed is in units of seconds.
4. Rotate the dial to change the number. The higher the number the faster the drive will accelerate to full speed. Factory settings should be at 5 sec.
5. Press and hold the jog dial till the value flashes to save.
6. Press “ESC” three times to return to rdY.

Deceleration of Discharge

1. Press the jog dial once and turn right one click until SEt is displayed.
2. Press the jog dial once and turn right one click until dEC.
3. Press the jog dial once to display data. The data that is displayed is in units of seconds.
4. Rotate the dial to change the number. The higher the number the longer it will take to decelerate the drive. Factory settings should be at 5 sec.
5. Press and hold the jog dial till the value flashes to save.
6. Press “ESC” three times to return to rdY.

Operational Procedures

The following operational procedures provide a step-by-step guide to starting-up and shutting-down your dryer. These procedures should be followed and used in conjunction with the Pinnacle Lite Controls Manual for HMI touchscreen adjustments.

Selecting Mode of Operation

It is important to understand the mode of operation. This will affect the way your Mathews Company grain dryer will run.

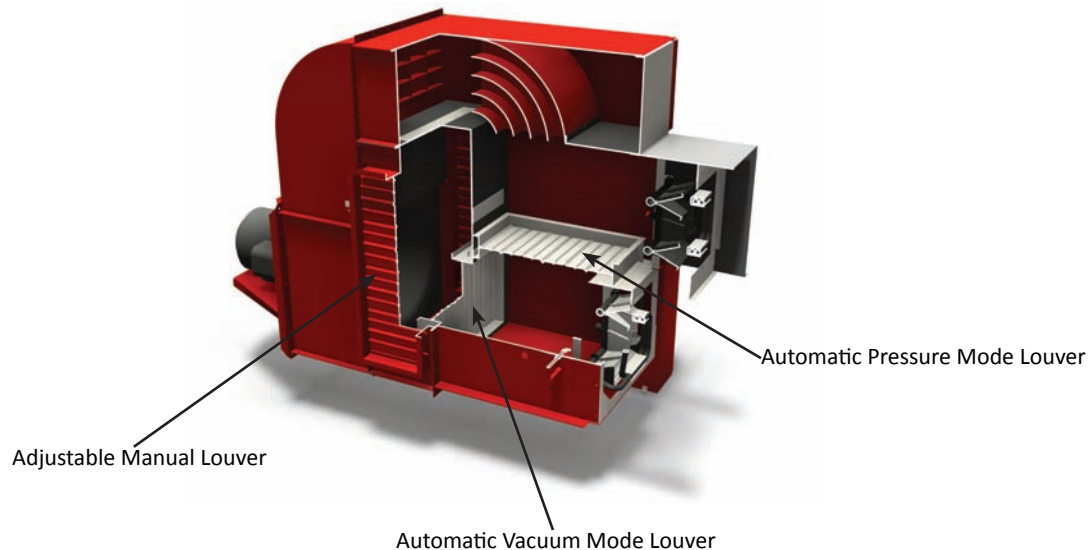

Pressure Heat Mode

1. Turn the mode selection switch to the pressure mode.
2. Allow for the automatic pressure louver to be opened 100%. This louver is located in the fan chamber. This louver is horizontal in the chamber.
3. The automatic vacuum louver will close to 100%. This louver is located in the fan chamber vertically.
4. Then set the outside manual louvers to line up with the proximity switch. Note that if the louver are not opened to the correct position the dryer will not fire.
5. Then ignite the top chamber burner, followed by the bottom chamber burner.

Pressure Heat + Cool Mode

1. Turn the mode selection switch to the pressure mode.
2. Allow for the automatic pressure louver to be opened 100%. This louver is located in the fan chamber. This louver is horizontal in the chamber.
3. The automatic vacuum louver will close to 100%. This louver is located in the fan chamber vertically.
4. Then set the outside manual louvers to line up with the proximity switch. Note that if the louver are not opened to the correct position the dryer will not fire.
5. Then ignite only the top burner.

Vacuum Heat + Cool Mode

1. Turn the mode selection switch to the pressure mode.
2. Allow for the automatic vacuum louver to be opened 100%. This louver is located in the fan chamber.



This louver is vertically in the chamber.

3. The automatic pressure louver will close to 100%. This louver is located in the fan chamber horizontally.
4. You can adjust the outside manual louver from 0% to 100% open.
5. Then ignite only the top burner.

First Time Start-Up

This start-up procedure assumes that the dryer has not recently been in operation and is not full of grain. For a repeated daily start-up, see the Daily Start-Up procedure portion of this section of the manual.

1. Choose your mode of operation (Pressure, Vacuum).
2. Once mode has been selected. Allow time for the mechanical louvers to open fully. Note that they must be opened 100% to engage the safety circuit.
3. In vacuum mode you can fully adjust the outside hand louvers. In pressure mode it is preferred to have the outside louvers opened 100%.
4. Adjust the high limit switch setpoint to approximately 40 deg F above the desired plenum temperature as explained in the High Limit portion of this section of the manual.. This should be done for all plenum high limit switches.
5. Set the grain fill delay timer and the grain flow timer as explained in the Grain Fill System portion of this section of the manual.
6. Turn the main disconnect located on the High Voltage Cabinet(s) to the on position.
7. On the Remote Control Cabinet, turn the momentary spring-loaded Control Power switch to the START position and release to the ON position. The Control Power light should illuminate.
8. On the Remote Control Cabinet, turn one of the momentary spring-loaded Fan switches to the START position and release to the ON position. The fan should start immediately and the switch should illuminate. Repeat this procedure for all of the fans, allowing time for each fan to get up to speed before starting the next.
9. On the Remote Control Cabinet, turn the Grain Fill switch to the MAN position and allow the dryer to fill completely. The level auger should start immediately, the switch should illuminate and your grain fill equipment should be commended to deliver grain to the dryer.
10. Once the dryer is full of grain, adjust each of the air pressure switches so the air pressure light illuminates as explained in the Air Pressure Switch portion of this section of the manual.
11. Set the plenum temperature setpoints for each plenum. You may refer to the table that follows for suggested drying temperatures based on model number and grain type. Setting the plenum temperature controllers can be done on the temperature controller directly located in the burner control box as explained in the Temperature Controller portion of this section of the manual or it can be done on the HMI touchscreen as explained in the Pinnacle Lite Controls Manual.
12. Open all manual gas supply valves so that fuel is free to flow to the burner once the gas valves controlled by the ignition system are opened.
13. On the Remote Control Cabinet, turn the ignition switch to the ON or the LO or HI position and after a 15 second delay, the Ignition switch will be illuminated and the burner will be lit.

14. Allow the dryer to warm up and dry the initial load of grain as a batch operation or be prepared to cycle the first batch back into the wet bin so that it may be processed through the dryer again on a continuous flow basis.
15. On the Remote Control Cabinet, turn the Grain Fill switch to the AUTO position. The grain fill system will now operate automatically as outlined in the Grain Fill System portion of this section of the manual.
16. Refer to the Pinnacle Lite Controls Manual for the requirements prior to starting the dryer's discharge. At a minimum, set the discharge mode to Manual on the HMI touchscreen and set the discharge speed setpoint (%) in accordance with the table that follows.
17. On the Remote Control Cabinet, turn the momentary spring-loaded Takeaway switch to the START position and release to the ON position. The discharge auger or conveyor (if equipped) should start immediately, the switch should illuminate and your takeaway equipment should start running. On the Remote Control Cabinet, turn the Metering switch to the ON position. The metering rolls should start immediately and the switch should illuminate. The dryer is now discharging grain and the discharge rate will be established by the Pinnacle Lite Control System. Refer to the Pinnacle Lite Controls Manual for more information.

Daily Shut-Down

This shutdown procedure assumes that the dryer will be put back into operation within 24-48 hours. If the grain drying operation will not resume within 24-48 hours, it is suggested that the dryer be emptied and the grain placed back into the appropriate storage. Grain dryers are not designed to be grain storage devices. Once all the grain has been dried, it needs to be emptied from the dryer and stored appropriately. Grain stored in a dryer for more than one week may cause damage to the machine. For an end-of season shut-down procedure, see the End-of-Season Shut Down portion of this section of the manual.

1. On the Remote Control Cabinet, turn the Metering switch and the Takeaway switch to the OFF position. Both switches should no longer be illuminated, the metering rolls and discharge auger or conveyor (if equipped) as well as your takeaway equipment should be stopped.
2. On the Remote Control Cabinet, turn the Grain Fill switch to the OFF position. The grain fill system will now be shutdown and your fill equipment will no longer be commanded to run.
3. Close the manual hand valves supplying fuel to the dryer. This will ensure the burners will run until all of the fuel in the line has been cleared out. Once the burner is extinguished, turn the ignition switch to the OFF position on the Remote Control Cabinet.
4. Let the fans continue to run for at least 15-20 minutes to cool the grain in the dryer. Once the grain has been cooled down, shutoff the fans by turning the momentary spring-loaded Fan switches to the OFF position.
5. On the Remote Control Cabinet, turn the momentary spring-loaded Control Power switch to the OFF position. The Control Power light should no longer be illuminated.
6. Turn the main disconnect located on the High Voltage Cabinet(s) to the off position.



Daily Start-Up

This start-up procedure assumes that the dryer has recently been in operation and is full of grain. For a first time start-up, see the Daily Start-Up procedure portion of this section of the manual.

1. Turn the main disconnect located on the High Voltage Cabinet(s) to the on position.
2. On the Remote Control Cabinet, turn the momentary spring-loaded Control Power switch to the START position and release to the ON position. The Control Power light should illuminate.
3. Choose your mode of operation (Pressure Heat, Pressure Heat + Cool, Vacuum Cool).
4. Once mode has been selected. Allow time for the mechanical louvers to open fully. Note that they must be opened 100% to engage the safety circuit.
5. In vacuum mode you can fully adjust the outside hand louvers. In pressure mode it is preferred to have the outside louvers opened 100%.
6. On the Remote Control Cabinet, turn one of the momentary spring-loaded Fan switches to the START position and release to the ON position. The fan should start immediately and the switch should illuminate. Repeat this procedure for all of the fans, allowing time for each fan to get up to speed before starting the next.
7. Verify the plenum temperature setpoints for each plenum. You may refer to the table that follows for suggested drying temperatures based on model number and grain type. Setting the plenum temperature controllers can be done on the temperature controller directly located in the burner control box as explained in the Temperature Controller portion of this section of the manual or it can be done on the HMI touchscreen as explained in the Pinnacle Lite Controls Manual.
8. Open all manual gas supply valves so that fuel is free to flow to the burner once the gas valves controlled by the ignition system are opened.
9. On the Remote Control Cabinet, turn the ignition switch to the ON or the LO or HI position and after a 15 second delay, the Ignition switch will be illuminated and the burner will be lit.
10. On the Remote Control Cabinet, turn the Grain Fill switch to the AUTO position. The grain fill system will now operate automatically as outlined in the Grain Fill System portion of this section of the manual.
11. Refer to the Pinnacle Lite Controls Manual for the requirements prior to starting the dryer's discharge. At a minimum, set the discharge mode to Manual on the HMI touchscreen and set the discharge speed setpoint (%) in accordance with the table that follows.
12. On the Remote Control Cabinet, turn the momentary spring-loaded Takeaway switch to the START position and release to the ON position. The discharge auger or conveyor (if equipped) should start immediately, the switch should illuminate and your takeaway equipment should start running. On the Remote Control Cabinet, turn the Metering switch to the ON position. The metering rolls should start immediately and the switch should illuminate. The dryer is now discharging grain and the discharge rate will be established by the Pinnacle Lite Control System. Refer to the Pinnacle Lite Controls Manual for more information.

End-of-Season Shut-Down

This shutdown procedure assumes that the dryer will not be put back into operation for an extended period of time and that all of the grain in the dryer will be dried and then subsequently emptied.

1. When the last of the grain to be dried has been put into the dryer, turn the Metering switch and the Takeaway switch to the OFF position on the Remote Control Cabinet. Both switches should no longer be illuminated, the metering rolls and discharge auger or conveyor (if equipped) as well as your takeaway equipment should be stopped.
2. Dry the remaining grain for approximately six minutes per point of moisture to be removed.
3. Close the manual hand valves supplying fuel to the dryer. This will ensure the burners will run until all of the fuel in the line has been cleared out. Once the burner is extinguished, turn the ignition switch to the OFF position on the Remote Control Cabinet.
4. Let the fans continue to run for at least 15-20 minutes to cool the grain in the dryer. Once the grain has been cooled down, shutoff the fans by turning the momentary spring-loaded Fan switches to the OFF position.
5. Set the discharge mode to Manual on the HMI touchscreen and set the discharge speed setpoint (%) as high as your takeaway system will allow.
6. On the Remote Control Cabinet, turn the momentary spring-loaded Takeaway switch to the START position and release to the ON position. The discharge auger or conveyor (if equipped) should start immediately, the switch should illuminate and your takeaway equipment should start running. On the Remote Control Cabinet, turn the Metering switch to the ON position. The metering rolls should start immediately and the switch should illuminate. The dryer is now discharging grain and the discharge rate will be established by the Pinnacle Lite Control System. Refer to the Pinnacle Lite Controls Manual for more information.
7. Allow the grain to be completely emptied from the dryer.
8. On the Remote Control Cabinet, turn the momentary spring-loaded Control Power switch to the OFF position. The Control Power light should no longer be illuminated.
9. Turn the main disconnect located on the High Voltage Cabinet(s) to the off position.
10. Refer to the Maintenance section of this manual for additional information on preparing your dryer for an extended shutdown.



Suggested Plenum Temperatures

Below are suggested plenum drying temperatures for a variety of grain types. These numbers represent the temperature that the burner will be putting out into the heating chamber.

		Plenum Drying Temperature					
		Corn		Sorghum & Wheat		Canola, Rape, Sunflower Oats, Barley, Soybeans	
Model #	Plenum #	deg F	deg C	deg F	deg C	deg F	deg C
T2030 - T2850	Top #2	230	110	170	77	140	60
	Bottom #1	Cool or 180	Cool or 82	Cool or 150	Cool or 66	Cool or 130	Cool or 54

Suggested Discharge Rate

Below are suggested discharge rate when drying at a variety of moisture levels. These numbers represent the speed on how fast or slow the dryer unloads the grain.

		All Heat					Heat + Cool					
		20%-15% Moisture			25%-15% Moisture		20%-15% Moisture			25%-15% Moisture		
Model #	bu/hr	tonnes/hr	speed	bu/hr	tonnes/hr	speed	bu/hr	tonnes/hr	speed	bu/hr	tonnes/hr	speed
T2030	710	16.5	53%	405	9.4	26%	375	8.7	24%	215	5.0	10%
T2440	850	19.8	52%	485	11.3	26%	455	10.6	24%	260	6.1	10%
T2850	990	23.1	52%	565	13.2	26%	525	12.2	24%	300	7.0	10%

Maintenance

Overview

This section of the manual will explain the factory recommended maintenance and cleaning requirements to keep your Mathews Company grain dryer running efficiently. Failure to follow or comply with these recommendations will impact dryer performance and may limit or void your warranty.

Pre-Season Checks

The following pre-season checks are intended to prepare your dryer for operation and bring any issues that may be present to your attention. Performing these check no later than 1-2 months before you intend to use the machine is recommended so that proper service can be performed and/or replacement parts can be ready before the harvest season begins.

Grain Fill & Discharge System

The following procedure will guide you through the grain fill and discharge system pre-season check. If the results of any of the following procedures are not consistent with what you should observe, service and/or replacement parts may be required. Contact your dealer or refer to the Troubleshooting section of this manual for more information.

1. Place all of the switches on the Remote Control Cabinet to the OFF position. Turn all of the circuit breakers in the bottom cabinet on. Turn the electric power supply to the dryer on.
2. On the Remote Control Cabinet, turn the momentary spring-loaded Control Power switch to the START position and release to the ON position. The Control Power light should illuminate.
3. On the Remote Control Cabinet, turn the Grain Fill switch to the MAN position. The level auger should start immediately and the switch should illuminate.
4. On the Remote Control Cabinet, turn the momentary spring-loaded Takeaway switch to the START position and release to the ON position. The discharge auger or conveyor (if equipped) should start immediately and the switch should illuminate.
5. On the Remote Control Cabinet, turn the Metering switch to the ON position. The metering rolls should start immediately and the switch should illuminate.

Belt Adjustment

All belts will eventually seat themselves in the pulley grooves and the tension may have to be re-adjusted. If the belts squeal when the motor starts, they are not tight enough. Never apply belt dressing as this will damage the belt and cause early belt failure.

Discharge Auger Belt

To adjust the belt tension on the discharge auger, loosen the unload auger motor mounting locknuts. Turn the locknut on the J-bolt to adjust the tension.

Level Auger Belt

Adjust the belt tension for the level auger by loosening the locknuts and raising the motor mount plate evenly with the four adjusting nuts, and then tighten the locknuts.



Fans & Burners

The following procedure will guide you through the fan and burner system pre-season check. Perform this procedure for all fans and burners installed on the machine. If the results of any of the following procedures are not consistent with what you should observe, service and/or replacement parts may be required. Contact your dealer or refer to the Troubleshooting section of this manual for more information.

1. Turn all switches on the Remote Control Cabinet to the off position and turn the electric power supply to the dryer off.
2. Close the burner gas manifold hand valve for each burner (handle 90° relative to the piping).
3. In order to test the burners without grain in the dryer, the air pressure switch will need to be jumpered. To do this, place a jumper wire with an alligator clip between the terminal of the fan start switch and the air pressure light terminal with the yellow wire of the burner being tested. Both the switch and light are located on the inside of the Remote Cabinet door.



This is only a temporary procedure for checking the burner. Under normal operation, never operate the dryer with the air pressure switches disconnected or bypassed. This safety air pressure switch is for your protection and the protection of the dryer.

4. Open all manual gas supply valves so that fuel is free to flow to the burner once the gas valves controlled by the ignition system are opened.
5. Turn the electric power supply to the dryer on.
6. On the Remote Control Cabinet, turn the momentary spring-loaded Control Power switch to the START position and release to the ON position. The Control Power light should illuminate.
7. On the Remote Control Cabinet, turn the momentary spring-loaded Fan switch to the START position and release to the ON position. The fan should start immediately, the switch should illuminate, and the air pressure light should illuminate.
8. Open the manual gas valve 1/4 of the way open to control the fuel flow to the burner once it has been lit.
9. Turn the ignition switch to the LO position and after a 15 second delay, the Ignition switch will be illuminated and the burner will be lit.
10. Let the burner run for at least two minutes to verify that it is properly operating.



Lubrication

Maintaining proper lubrication of all moving components of your dryer is key to its efficient and safe operation. The following table below outlines all recommended lubrication. Note that some of the items may not be applicable based on configured options, model or accessories.

Item	Lubrication Required	Interval
50:1 Gearbox Oil Level	Fill 1/4" over gear with SAE 90 gear lubricant	Maintain proper level. Check every 100 hours
50:1 Gearbox Grease Fitting	Uses (5) strokes of gun grease	At the beginning and end of the season.
Universal Joints	Use (1) strokes of gun grease	Every 50 hours of operation.
Motors	Lubricate with SR-2 (Chevron) grease or equivalent	Prior to operation and at the end of the season.
Motor Bearings	Use Exxon Corp-Plyres-em product or Chevron, Inc-SRI#2. Grease should be lithium based.	At the beginning and the end of the season.
Centrifugal Fan Bearings	Use only #2 consistency lithium based grease with high quality mineral oil with rust and oxidation inhibitor. Use Shell Alvania #2 Mobil Mobilux #2 or Texaco Multifak #2	At the beginning of the season and every 100 hours until the end of the season.
Unload Auger Bearings	Shell Alvania #2, Mobil Mobilux #2 or Texaco Multifak #2	Grease every 100 hours, unless extremely dirty conditions, once daily / weekly.
Metering Roll Bearings	Use grade #2 mineral oil lithium or lithium complex base grease.	At the beginning and the end of the season. Internal bearings are brass and do not need lubrication.

Seasonal Cleaning

During the course of the drying season, it is important to keep the dryer operating at its peak efficiency by performing periodic maintenance and cleaning of the equipment. When the screens of a dryer are clean, the air moves freely through the grain walls. As debris builds up inside the dryer, this can result in the combustion of debris which may lead to a fire. As such, cleaning of the grain dryer should be performed on a daily basis. Try to keep the surroundings of the dryer clean at all times to prevent breeding grounds for insects and other pests.



The recommended method for cleaning the dryer is air or water, preferably from a compressed-air source or even a vacuum, however, using a non-metallic brush or broom also works. Be aware that if using water to clean the dryer, the combination of water and residue can form a paste, making the surfaces sticky and more difficult to remove.

Outer Screens

The outer screens of the dryer need to be kept as clean as possible for safety and performance reasons. The perforation of the screens allow heated air, saturated with moisture from the grain, to exit to the atmosphere. This process also creates a damp environment on the outside of the screens, creating a buildup of fines and dust which reduces air flow resulting in a decrease of capacity and higher cost of drying.

Cleaning of the outer screens can be done during the drying process, but it may temporarily affect the discharge capacity if water is used. The preferred way to clean is to brush down the screens while grain is being dried as this will help push material out of the perforations in the screens. The discharge rate should increase after cleaning of the dryer because more surface area is now being exposed to the heated air passing through the grain columns.

Inner Screens

The procedure for cleaning the inner screens is similar to that of cleaning the outer screens. When cleaning the inside of the dryer, the use of a protective breathing mask is recommended. Using a non-metallic brush or broom, sweep the inner screens and channel rings going from top to bottom. Check the burner to make sure the wires look good and the burner is clean of debris. Sweep the plenum floors and remove any debris.

Post-Season Maintenance

After the drying season, the following steps are recommended to put your dryer into a condition suitable for an extended period of non-operational time.

1. Disconnect all power and turn off the gas supply.
2. Perform one final cleaning of the dryer inside and out as previously explained in the Seasonal Cleaning section of the manual. Use a power washer on the outer screens if dirt has filled the perforations on the screens.
3. Open the plenum access doors and sweep out all foreign material.
4. Visually inspect all bearings to see if there is indication of one in need of replacement. Inspect the drive belts and chains and note if any are in need of replacement or lubrication.
5. Grease all fan motor bearings and fan bearings as recommended in the Lubrication section of the manual.
6. Use a vacuum cleaner to remove any dirt from the control cabinet.



Troubleshooting

The Troubleshooting section will help with diagnosing your dryer in case of a dryer shut down. This section will explain situations that you may run into and will help you come up with a resolution to get your dryer back to operation.

Diagnosing a Dryer Shutdown

The safety of your dryer is in the hands of the safety circuit. These are a series of components that are tied together. If one fails the system will shutdown insuring the safety of your grain dryer.

Safety Circuit Overview

The contacts for incoming hot and neutral are found in the High Voltage cabinet.

The 120 volt input power to the dryer circuit for dryer controls comes from the bottom side of the transformer and runs to the top of the 8 amp mini-breaker. This breaker should be turned off and the voltage should be checked before turning the mini-breaker on. If the voltage reads anything outside of 125-volts, the supply voltage needs to be checked before powering on the mini-breaker.

Next to the mini breaker is a neutral block, which feeds all neutrals throughout the entire dryer. This neutral is connected to the neutral from the secondary side of the transformer that is standard equipment.

The incoming neutral line is connected to **TB5** (white wire) and the hot line is on **TB33** (after circuit breaker). The incoming 120-volt supply is an 8 amp mini-breaker.

Using a volt meter, hook one lead to **TB5** and set the meter to AC voltage (sign wave or “V”)

- Start by opening the Remote Cabinet and place a jumper wire between **TB33** and **TB34**. This will by pass the door switch on the Remote Cabinet and help with the process of diagnosing the problem. This is just a temporary jumper wire and should be removed once problem is resolved.
- In the Remote Cabinet place the second lead on **TB33**. If 110 or 120-volts show on the meter, then the mini-breaker is good if no voltage appears on the meter, then the mini breaker is tripped or off.
- In the Remote Cabinet place the second lead on **TB53**. Turn the power switch to the **ON** position. If it shows 120-volts, then move to the next step. If no voltage is read on the meter, then there is a problem with the power on or the safety interlock switch on the remote cabinet door.
- In the High Voltage Cabinet place the second lead on **TB53**. Turn the power switch to the **ON** position. If it shows 120-volts, then move to the next step. If no voltage is read on the meter, then there is a problem with the power on or the safety interlock switch on the remote cabinet door.
- In the High Voltage Cabinet place second lead on **TB19**, if it shows 120-volts, move to the next step. If there is no voltage on the meter, reset all manual motor protectors as the AC drive unit may have went into fault. To reset the AC drive, turn off the mini breaker for the drive. Wait until the AC drive unit screen goes blank. Restore the mini-breaker to the ON position and the drive will restart automatically.
- In the High Voltage Cabinet place the second lead on **TBC5**, if it shows 120-volts then move onto the next step. If there is no voltage on the meter, then the jumper from C5 to C6 has become disconnected.



- If the end-user has pulled the jumper and installed take away and fill equipment into the safety circuit, check to see if the customer's remote starter equipment needs to be reset.
- In the High Voltage Cabinet place the second lead on **TBC6**, if it shows 120-volts then move onto the next step. If there is no voltage on the meter, then the jumper from C5 to C6 has become disconnected. If the end-user has pulled the jumper and installed take away and fill equipment into the safety circuit, check to see if the customer's remote starter equipment needs to be reset.
- In the High Voltage Cabinet place the second lead on **TB22**, if it shows 120-volts then move onto the next step. If there is no voltage on the meter, then check connection between **TBC6** and **TB22**.
- In the High Voltage Cabinet place the second lead on **TB25**, if it shows 120-volts, move onto the next step. If there is no voltage on the meter, then the whisker switch on the dump door has tripped. Check the customer's takeaway system.
- In the High Voltage Cabinet place the second lead on **TB257(if equipped with plenum door switch(es))**, if it shows 120-volts then move onto the next step. If there is no voltage on the meter, then one of the plenum door switches is open. Check to see if the plenum doors are tightly shut or if the switch is mis-adjusted.
- Place the second lead on **TB20**, if it shows 120-volts, move onto the next step. If there is no voltage on the meter, then the first high limit has tripped it must be manually reset on the high limit itself.
- Continue to check the other high limits by following the process above and check TB28 (Burner #2) TB283 (Burner #3) TB248 (Burner #4) TB285 (Burner #5) TB286 (Burner #6) TB287 (Burner #7).
- In the High Voltage Cabinet place the second lead on **TB10**, if it shows 120-volts, move onto the next step. If there is no voltage on the meter, check the connection between **TB20** and TB10.
- In the High Voltage Cabinet place the second lead on **TB23**, if it shows 120-volts move onto the next step. If there is no voltage on the meter, then the linear limits if equipped have overheated and must be checked. When linear limits overheat (218°F), they will automatically reset when the temperature drops below 218°F. If they do not reset, they will need to be replaced. These can be checked by powering off and running continuity test through each linear limit module.
- In the High Voltage Cabinet place the second lead on **TB24**; if it shows 120-volts, the safety circuit is completed. If there is no voltage on the meter, then there is a problem with the main relay, 0-60 minute timer, or the relay/timer board. There is a DC rectifier on the side of the board if this goes bad then the board has seen a spike in voltage and needs to be replaced.
- **TB24** is the main supply distribution point that will feed voltage to the fill circuit, fan/burner circuit, and discharge circuit. These three circuits are all independently powered up.

Customer Interface

Customer connections are for remote equipment, and are used to interface the grain dryer with your fill and takeaway equipment. The grain dryer does not supply power for these interfaces. An auxiliary power source should be used to power your equipment.

Customer Connections

- **C1-C2** = remote fill equipment
- **C3-C4** = remote discharge equipment
- **C5-C6** = dryer safety circuits for remote starters

C1-C2. **C1** and **C2** are a dry set of contacts that close when the dryer fill cycle begins. When this closes, the dryer will start the customer's equipment.

C3-C4 **C3** and **C4** are a dry set of contacts that close when the dryer discharge system begins. When this closes, the dryer will start the customer's equipment.

C5-C6 is part of the dryer safety circuit and carries 120 volts as long as the dryer power switch is in the ON position. The dryer is delivered with a jumper across **C5** and **C6** to allow complete testing of the safety circuit. The jumper can be removed and the two wires that run from **C5** and **C6** can be connected to external motor starter overloads that will be engaged when the dryer is running. Remember that the dryer is providing power from **C5** to **C6** and must be tied to a dry set of contacts on the customers equipment.

Temperature Controller

If in case you run into a problem with the temperature controller this section will help diagnose the situation.

Always Overshoots the Setpoint Temperature

If the temperature is consistently overshooting the set point and tripping the alarm on the controller, adjustments to the controller are necessary.

- Press the up and down arrows 3 second till tune is displayed.
- Press the up arrow once till bAnd is displayed.
- Increasing the proportional band will help with overshoot.
- Hit the up arrow 3 more times until dAC is displayed. The derivative approach control works in conjunction with the proportional band to control overshoot.
- It must also be noted that increasing the dAC will additionally help with overshoot.



The three components for controlling overshoot are gas pressure, proportional band, and derivative approach control.

Unable to Reach Setpoint Temperature

If the setpoint cannot be achieved, even when the valve is 100% open, there is not enough gas pressure to obtain the selected plenum temperature. Adjust the pressure to obtain proper temperature. The controller will start to control the opening of the valve. The closer to the set point, the more the controller will shut the valve until the desired temperature is reached.



Plenum Temperature will not hold satisfactorily

- Adjust the gas pressure (Lower for Overshoot : Higher for Low Temp).
- Loosen the linkage on the arm connecting the modutrol motor and the proportional value.
- Then attempt to move the shaft on the butterfly valve to see if the valve is in working order.
- Attempt to tune at the set point.



Plenum Temperature must be close to the setpoint to start this function

- Press both arrow keys simultaneously and hold down for 3 seconds. Display will show tune off.
- Press ▲ arrow up until display reads bAnd-[number]
- Press * and arrow until number is twenty (20).
- Press down arrow until display reads tune off. Press * and up arrow until display shows *tune –At.SP.*
- Hold down both arrows for three seconds for the auto tuning function.



If in danger of becoming “lost in program mode,” press the ▼ and ▲ together for 3 seconds to return to display mode, check the adjustments above and try again.

When in program mode, after 60 seconds of key inactivity, the display will revert to either inPt: none or, if the initial configuration has been completed, the measured value. Any setting already completed will be retained. To inhibit automatic program exit select ProG StAY in level 4.

Controller Fault Codes

(-AL-) This indicates that both the high and low plenum temperature conditions shutdown the dryer. You can reset the controller by either holding the High Limit, and Air Pressure button in the Remote cabinet. You can also do this directly on the Temperature controller by holding the two outside buttons.

(iNPT- FAiL) If these two words will flash back and forth. This condition is an invalid plenum chamber temperature signal back to the Temperature Controller. Check the temperature input device wires to Temperature Controller. This could also mean that that the Plenum RTD has gone bad and needs to be replaced.

(dAtA - FAiL) If these two words will flash back and forth. This condition is failure of an internal component on the controller. The Temperature Controller needs to be replaced.

(tunE - FAiL) These two words will flash back and forth. The Temperature Controller could not complete the auto tune process. This will occur when trying to auto tune. Something happened in the process to make the auto tuning process become corrupt. Restart the auto tuning process again to establish a good set of PID values to properly control temperature.



Variable Frequency Drive (VFD)

In case that you run into a error code on the variable frequency drive (VFD) listed below are the display faults that will show up on the main display of the drive.

Display Faults

- **OCF**=Over current
- **SCF**=Motor short circuit insulation fault
- **InF**=Internal fault
- **CFF**=Configuration fault
- **SOF**=Over speed
- **OHF**=Drive overload
- **OLF**=Motor overload
- **OSF**=Over voltage
- **ObF**=Over voltage during deceleration
- **PHF**=Line phase failure
- **USF**=Under voltage
- **CrF**=Charging circuit

Fault Code Description

Described below is the fault code and a description of the fault. This will also give you an action to help resolve the issue.

Fault Code	Description of Fault	Action to Resolve
CrF	Pre-Charge Circuit Damage	Reset Drive (Power Down)
InF	Internal Fault	Replace Drive Unit
OCF	Over Current Fault	Driver Undersized For Load, Check Set & drC
SCF	Motor Short Circuit	Wiring Shorted To Ground, Check Continuity
SOF	Over Speed Fault	Instability
tnF	Auto Tuning Fault	N/A
COF	N/A	N/A
EPF	External Fault	Fault outside Drive
LFF	Loss Reference Signal	Check Wiring Connection, Check Signal Source
Obf	Over voltage During Deceleration	Overhauling Load Or Stopping To Quickly
OHF	Drive Overload	Ambient Temperature Is Too High, Check Motor Amps
OLF	Motor Overload	Thermal Protection Trip, Let Motor Cool, Check itH
OPF	Motor Phase Fault	Loss Of Phase To Motor, Check Connections
OSF	Over Voltage During Steady State	Line Voltage Too High
PHF	Input Phase Failure	Motor Leads Not Wired In Proper Order For Rotation
SLF	Serial Linked Failure Modbus	N/A
CFF	Configuration Fault	Reload Parameters
CFI	Configuration Fault With Serial Port	N/A
USF	Under Voltage	Lost Input Power To Drive



Common Diagnostic Issues

If in case that you run into an issue, listed below are common issues that may occur while operating your Mathews Company grain dryer.

Problem:

Dryer will not reach operating temperature, or it reaches it slowly.

Possible Cause/Solution:

1. Low gas pressure. Increases gas pressure on the main gas regulatory.
2. Check for water in the gas train by opening the drain valve.
3. Make sure the dryer is completely full of grain by entering the heat plenum chamber and looking for daylight in one of the grain columns.
4. Make sure that the gas butterfly valve is being driven wide open by the modutrol motor. If not, check the motor or motor linkage. Also check to make sure that there is not a block within the gas piping. There should be 10 pounds on the primary regulator and 1 to 2 pounds on the secondary.

Problem:

Blower motor(s) will not start.

Possible Cause/Solution:

1. Check that the fan circuit breaker and the fan switch are on. Also, check for a defective switch or bad wire connections.
2. Verify closing of the fan motor contactor. Check voltage on the load side of the contactor.
3. Inspect the contactor for defective contact or a burned out coil.
4. Inspect connections, and check voltage applied to the motor leads to determine if the motor is defective.

If the motor starts slowly, check for low voltage during starting due to excessive voltage drop in power supply wiring.

Problem:

Burner will not fire.

Possible Cause/Solution:

1. Check gas supply for possible obstruction or closed valves. Refill tank; replace or repair parts as required.
2. Inspect gas solenoid valves for defective coils or improper wiring. Replace the valve or coil if the valve will not open with proper voltage applied (115 volts).



Problem:

Burner will not fire, but gauge shows gas pressure.

Possible Cause/Solution:

1. Check that the igniter is properly gapped and has a strong spark.
2. Inspect the porcelain and electrodes for damage or cracking. Clean or replace if necessary.
3. Machine does not have chassis ground.
4. Check solenoids for proper operation.

Problem:

Uneven drying, some kernels appear brown while others are under dried. Uneven heat exiting from dryer columns.

Possible Cause/Solution:

1. Check plenum temperature setting. Some varieties of grain are more sensitive to higher operating temperatures. It may be necessary to lower the plenum operating temperature to accommodate this.

Problem:

Grain is not moving through columns.

Possible Cause/Solution:

1. Check the dryer for fine material buildup inside the columns.
2. Avoid leaving the dryer columns full for long periods at a time (2-3 days) while not operating the dryer, or during rainy weather.
3. Empty the dryer and clean regularly. Do not allow fine material to gather in the plenum chamber.

Problem:

Difficult lighting the burner

Possible Cause/Solution:

1. Fan must be ON to achieve air pressure light.
2. Ignition switch set to the ON position. This applies 120 VAC at L1 (0 volts at L2 Neutral) of the ignition board.
3. After pre-purge time, the ignition board should power out 120 VAC at V1 (V2 neutral) for a trial ignition period to eliminate the gas valve light and gas valve light. The ignition trial time is 7 seconds. If the trial is not successful, voltage outputs stop.
4. Check the gas solenoid operation by listening for a click/snap or feeling the vibration as they open. If the solenoid doesn't open, check the wiring and coil for damage, bad connections, etc.
5. Check the spark plug (igniter) for spark. Check the high voltage wire for damage, good connections.
6. Replace the ignition board.



Problem:

The burner lights but does not stay on.

Possible Cause/Solution:

(NOTE: This is most likely due to the flame sensing)

1. Ensure flame sense probe is located in the flame.
2. Inspect the sense wire for damage and for loose or wet connections.
3. Check that sense wire is routed separately from the high voltage ignition wire.
4. Check the ignition board (B.GND) is grounded separately from all other connections. Sharing a ground connection can cause problems.
5. Clean sense probe with fine steel wool.

Burner may have to be grounded at the burner body directly to the burner housing







Mathews Company

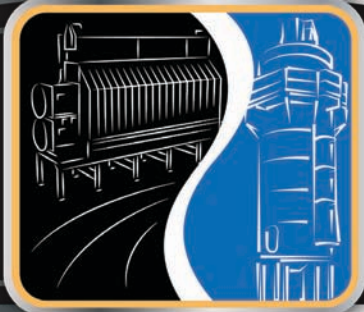

1954

2014

60th Anniversary

GRAIN DRYER SPECIALISTS



Mathews Company
www.MathewsCompany.com

Crystal Lake, IL
phone: 815-459-2210
fax: 815-459-5889
email: mcsales@mathewscompany.com