

OPERATIONS MANUAL - TOWER SERIES



© 2018 Mathews Company
500 Industrial Avenue
Crystal Lake, IL 60012 USA
www.mathewscompany.com

CSA 3.8 2014 Certified Dryers



The following instructions pertain to dryers built and certified to the CSA 3.8 2014 standard and is meant for qualified personnel only.

Gas Installation

The equipment shall be installed in accordance with the Natural Gas and Propane Installation Code, CSA B149.1 and the Propane Storage and Handling Code, CSA B149.2, or applicable provincial regulations, which should be carefully followed in all cases. Authorities having jurisdiction should be consulted before installations are made.

Installation of Fuel Piping

LP

LP installations shall conform to the following:

- The LP supplier must install the appropriate supply line in Type K copper underground from the supply tank to the edge of the concrete pad as per B149.1,2. This is solely the responsibility of the fuel supplier under the Z code.
- If an underground installation is not preferred, a continuous run of black iron and copper can be installed above the concrete.
- A continuous piece of type K copper can be used through or under the concrete provided that it is protected by sleeves or in a channel. A coil at the final connection can be used as an expansion provided it is not kinked.
- A typical installation on LPG starts with the Type K copper ending at the pad followed by a swing joint attached to lengths of SK80 piping fittings with resign coated hanger brackets attached to the concrete to avoid galvanic reaction. The final connection shall have a swing joint or category 1 expansion hose no longer than 3 feet in length followed by a SK 80 union to facilitate removal and final attachment to ball valve supplied by manufacturer.

Pertinent code clauses pertaining to basic installation:

- B149.1 6.16.3 piping and tubing shall be mounted and braced to provide for vibration, contraction or jarring.
- B149.1 6.14.1 a defective section of piping or tubing shall be replaced
- B149.1 6.14.5 piping shall not be field bent
- B149.1 6.9.6 joint sealant shall conform to Can/ulc 642 and shall be applied to male threads of the pipe
- B149.1 6.8.1 piping ends shall be free of cuttings and burs
- B149.1 6.8.2 piping shall be reamed
- B149.1 6.14.2 bushings shall not be nested
- B149.1 6.11.9 provide effective swing joints at manifolds to accommodate for expansion and contraction and ground level and at appliance level
- B149.1 6.20.5 metallic gas hose can be used in commercial or industrial environments where vibrations, expansions or contractions are present.
- B149.1 6.20.3 gas hose for a PERMANENT installation shall not exceed 10 feet in length a permanent installation consists of an appliance hard wired to the electrical source a generator or PTO is considered temporary and can be moved.
- B149.1 6.16.1 piping exposed to atmospheres shall be painted or coated
- B149.1 6.17.1 standard practice paint Liquid propane piping RED.
- B149.1 union should be installed to facilitate removal of piping if required.

- B149.1 6.2.2 a fitting used shall with steel shall be malleable iron or steel
- B149.1 hydrostatic relief devices shall be used where liquid propane can be trapped and vented to a safe location
- B149.1 6.4.3 schedule 80 piping and fittings shall be used on liquid phase systems or over 125 psi
- B149.1 6.16.6 when piping or tubing is run in a sleeve the sleeve shall be of a type of material that will avoid galvanic reaction and protect the tubing
- B149.1 6.15.10 when tubing is laid under pavement and re-enters above ground a sleeve shall be used to protect the tubing through the concrete.
- B149.1 6.2.15 plastic pipe shall not be used in a liquid piping system
- B149.1 6.4.17 close nipples, street elbow or street T shall not be used
- B149.1 6.2.5 flare nuts shall not be externally forged or machined and shall be of the forged type
- B149.1 6.2.4 copper shall be of the type K,G or L
- B149.1 6.9.9 a joint in seamless copper shall be of a flared type

NG

NG installations shall conform to the following:

- Typically a gas meter is installed 15 feet away from the grain dryer. A pipe can be extended with a union to the pavement level with a swing joint before attaching to the pavement as the meter can move independently from the concrete pad. This can then be followed by a length of pipe to an additional swing joint, or type 2 gas hose, acting as a swing joint attached to the final connection with a union. There shall be a shut off valve after the union.

Pertinent code clauses pertaining to basic installation:

- B149.1 6.4.17 close nipples, street elbow or street T shall not be used
- B149.1 union should be installed to facilitate removal of piping if required.
- B149.1 6.2.2 a fitting used shall with steel shall be malleable iron or steel
- B149.1 6.20.3 gas hose for a PERMANENT installation shall not exceed 10 feet in length a permanent installation consists of an appliance hard wired to the electrical source a generator or PTO is considered temporary and can be moved.
- B149.1 6.16.1 piping exposed to atmospheres shall be painted or coated yellow
- B149.1 6.16.3 piping and tubing shall be mounted and braced to provide for vibration, contraction or jarring.
- B149.1 6.14.1 a defective section of piping or tubing shall be replaced
- B149.1 6.14.5 piping shall not be field bent
- B149.1 6.9.6 joint sealant shall conform to Can/ulc 642 and shall be applied to male threads of the pipe
- B149.1 6.8.1 piping ends shall be free of cuttings and burs
- B149.1 6.8.2 piping shall be reamed
- B149.1 6.14.2 Bushings shall not be nested
- B149.1 6.11.9 provide effective swing joints at manifolds to accommodate for expansion and contraction and ground level and at appliance level
- B149.1 6.20.5 metallic gas hose can be used in commercial or industrial environments where vibrations, expansions or contractions are present.
- B149.1 6.20.3 gas hose for a PERMANENT installation shall not exceed 10 feet in length a permanent installation consists of an appliance hard wired to the electrical source a generator or PTO is considered temporary and can be moved.
- B149.1 6.4.3 schedule 40 piping and fittings shall be used on systems or under 125 psi

Field Installed Wiring

Dryer wiring from the branch circuit is included in the field installation wiring schematic. All wiring is to be in accordance with the Canadian Electrical Code, Part1, CSA C22.1

This dryer is not service rated, and will require an additional overload protection device in front of the dryer for adequate protection. All wiring is to be in accordance with the Canadian Electrical Code, Part1, CSA C22.1.

The electrical installation should follow domestic NEC standards.

Minimum wire size is 18awg unless specified.

All wire gauges shown on the drawing are recommended only! Electrical contractor should follow the local codes and authority having jurisdiction.

All wire sizing based on copper conductors, but aluminum may be used if sized correctly.

This dryer is not service rated. Proper service protection is recommended.

Pressure Testing

The dryer and its individual shutoff valve must be disconnected from the gas supply piping system during any pressure testing of that system at test pressures in excess of 1/2 psi (3.5 kPa). The dryer must be isolated from the gas supply piping system by closing its individual manual shutoff valve during any pressure testing of the gas supply piping system at test pressures equal to or less than 1/2 psi (3.5 kPa)

Min/Max Gas Supply Pressures

Refer to the dryer rating plate for determining the minimum gas supply pressure for obtaining the maximum gas capacity for which this dryer is specified.

Leak Tests

Gas leak tests need to be performed during dryer start-up to verify the gas-tightness of the dryer's components and piping under normal operating conditions. During the tests, observations should be made at the gauges attached to the unit. If the gauges are reading 0, there could be a leak as the system is normally under pressure. A soapy water solution can be used to check fittings for leaks while the unit is in operation by a 60/40 mixture of soap and water with a brush. Gauges can be installed before and after the safety shutoff valves. The unit can be bumped and shut off. If the gauges return to 0, a leak could be present.

Gas Tightness Check

Safety shut off valves need to be tested for tightness annually. To test, inlet connections should be soap tested up to the safety shut-off valves or solenoid. From there, install gauges in between the safety shut-off valves or solenoids. Fire up the dryer with the firing valve closed. The firing valve is the valve located just before the burner. The safety shut-off valves will open, pressurizing the system and allowing the gauges to read pressure. The dryer will fail on ignition and the gauges should remain pressurized. If the gauges drop in pressure with the firing valve closed, that would indicate a potential leak. If the gauges return to 0 soap testing should commence on all fittings.

Venting

The following specifications need to be followed in regards to venting:

- B149.1 5.4.1 hydrostats must be vented to a “safe location”
- B149.1 5.4.2 hydrostats may be vented into a common header provided the cross sectional area is equal to the cross sectional area of the multiple vents IE: 2 /12 “ hydrostats must vent into a 1” line
- B149.1 5.5.6 vents must be designed not to allow water, insects or debris simply put use a drip and a 90 at the end of the pipe with a screen
- B149.1 5.5.9 vents shall terminate 10 feet from mechanical air intake
- B149.1 5.5.8 vents shall not be capped off or made in-operable
- B149.1 5.5.4 vents shall not be reduced in size as to impede on the performance.

Emergency Manual Shut-off Valve

The gas piping installer must install a manual emergency shutoff valve in an appropriate location that allows access to this valve to shut off the fuel to the dryer in case of a fire or explosion at the dryer. This installation must conform to the following:

- B149.1 6.18.2 a readily accessible manual shutoff valve must be installed as per below. Either one is acceptable.
- In the drop or rise, as close as possible to the valve train of a commercial or industrial valve train.
- In the horizontal piping of the drop or riser and the appliance valve train within 2 feet of the appliance.

Warning

If the information in the operations manual is not followed exactly, a fire or explosion may result causing property damage, personal injury or loss of life.

Do not store or use gasoline or other flammable vapors and liquids in the vicinity of this or any other appliance.

What To Do If You Smell Gas

- Do not try to light any appliance
- Extinguish any open flames
- Do not touch any electrical switch
- Immediately call your gas supplier. Follow the gas supplier’s instructions
- If you cannot reach your gas supplier, call the fire department.
- Installation and service must be performed by a qualified installer, service agency or the gas supplier
- Improper installations, adjustment, alteration, service or maintenance can cause property damage, injury or death. Read the installation, operating, and maintenance instructions thoroughly before installing or servicing this equipment.

For Your Safety

The use and storage of gasoline and other flammable vapors and liquids in open containers in the vicinity of this appliance is hazardous. Refer to codes and standards CSA 3.8, 4.29.7

Warranty Statement

MATHEWS COMPANY LIMITED WARRANTY FOR WHOLE GOODS



Except as otherwise set forth herein, Mathews Company (Seller) warrants that the equipment supplied by Seller to Buyer shall be free from defects in materials and workmanship when properly installed and operated under normal conditions and in accordance with all applicable instruction manuals. This limited warranty shall expire two (2) years from the date of shipment from Seller's Crystal Lake, Illinois, U.S.A. facility. In addition, for a period of five (5) years from the date of shipment from Seller's Crystal Lake, Illinois, U.S.A. facility, Seller will re-balance M-C Shredder rotors for Buyer at Seller's Crystal Lake, Illinois, U.S.A. facility, provided that the rotors did not become unbalanced through abnormal use by Buyer or were not damaged by Buyer in any way.

To obtain consideration under this limited warranty, Buyer must first notify Seller in Crystal Lake, Illinois, U.S.A., stating in what respects the equipment is believed by Buyer to be defective and providing a list of the parts at issue. Additionally, Buyer must complete a warranty request form stating the machine serial number. Upon receipt by Seller of such notice from Buyer, Buyer may receive authorization from Seller to return the parts. If parts are to be scrapped locally, Buyer will be so advised. If Seller provides Buyer with authorization to return the parts, Buyer shall return such parts to Seller's facility in Crystal Lake, Illinois, U.S.A., transportation prepaid, for examination by Seller. No parts shall be returned to Seller unless Buyer first obtains a return authorization number from Seller. If, in Seller's sole judgment, the parts returned by Buyer are defective and covered under this limited warranty, Seller shall have the option of repairing, rebuilding or replacing such parts. This limited warranty shall not apply to parts which, in Seller's sole judgment, have been the subject of negligence, abuse, accident, misapplication, tampering, alteration, improper adjustment, or electrical problems caused by low voltage conditions; nor shall it apply to consumables, such as belts; nor shall it apply to parts damaged by acts of God, war or civil insurrection, acts of terrorism, improper installation, operation, maintenance or storage, or other than normal application, use or service, including, without limitation, operational failures caused by corrosion, erosion, wear and tear, rust or other foreign materials in the system in which they are utilized.

Failure to give notice within the warranty period shall be a waiver of this limited warranty and no assistance or other action thereafter taken by Seller shall be deemed to extend or revive the warranty period. This limited warranty covers only whole goods and shall not apply to replacement parts or upgrade kits. A separate warranty statement published by Seller covers the warranty on parts and upgrade kits. This limited warranty shall not apply to any products, parts, accessories or other equipment not manufactured by Seller, provided that Seller, upon request by Buyer, shall advise Buyer of any warranties known to Seller that may be offered by the manufacturer of such equipment. This limited warranty shall not cover, and Seller shall not under any circumstances be liable for, damages for injuries to persons or property; loss of crops or other products; losses caused by harvest delays; loss of profits; loss of use; cost of rental equipment; expenses of labor, travel or other items relating to the removal or replacement of defective parts; damages resulting from the removal of defective parts or the installation of repaired, rebuilt or replaced parts; expenses relating to the transportation of parts to and from Seller's facility; any consequential, incidental, contingent or special damages, whether arising in contract, in tort or under statute; or any other damages or expenses not agreed upon in writing by Seller, even if Seller has been advised of the potential for any such damages or expenses.

THIS LIMITED WARRANTY IS IN LIEU OF ALL WARRANTIES, EXPRESS OR IMPLIED, INCLUDING, WITHOUT LIMITATION, ALL WARRANTIES OF MERCHANTABILITY AND FITNESS FOR A PARTICULAR PURPOSE OR USE. No person is authorized to give any other warranty or to assume any other liability on Seller's behalf.

Table of Contents

| | | |
|---|--|-------------|
|  | Introduction | 1.1 |
| | Overview | 1.1 |
| | Grain Drying Principles | 1.1 |
| | Air | 1.1 |
| | Heat | 1.1 |
| | Time..... | 1.1 |
| | Owner / Operator Notes | 1.2 |
| | Warranty Registration | 1.2 |
| | Model / Serial Number / Specifications | 1.2 |
| | Safety | 1.3 |
| | Lock-out / Tag-out Requirements | 1.4 |
| | Blocks..... | 1.5 |
| | Fire Emergency | 1.5 |
|  | Specifications | 2.1 |
| | 10' Tower Specifications | 2.1 |
| | 10530 Dimensions | 2.2 |
| | 10740 Dimensions (Shown With Optional Walkway) | 2.3 |
| | 10950 Dimensions | 2.4 |
| | 101160 Dimensions | 2.5 |
| | 101375 Dimensions | 2.6 |
| | 12' Tower Specifications | 2.7 |
| | 12-20-100 Dimensions..... | 2.8 |
| | 12-24-125 Dimensions..... | 2.9 |
| | 12-28-150 Dimensions..... | 2.10 |
| | 18' Tower Specifications | 2.11 |
| | 3000 Dimensions | 2.12 |
| | 3500 Dimensions | 2.13 |
| | 4000 Dimensions | 2.14 |
| | 4800 Dimensions | 2.15 |
|  | Equipment Overview | 3.1 |
| | Main Dryer Components | 3.1 |
| | High Voltage Cabinet | 3.3 |
| | 10' Tower High Voltage Cabinet..... | 3.3 |
| | 12' Tower High Voltage Cabinet..... | 3.4 |
| | 18' Tower Tri-Start | 3.5 |
| | Low Voltage Cabinet | 3.7 |
| | Pinnacle 20 20 Remote Cabinet | 3.8 |
| | Pinnacle 20 20 Customer Equipment Cabinet | 3.9 |
| | Ignition Cabinet | 3.10 |
| | 10' Tower Ignition Cabinet..... | 3.10 |
| | 12' /18' Tower Ignition Cabinet | 3.11 |
| | Discharge Moisture Sampler | 3.12 |
| | Gas Train | 3.13 |
| | 10' Tower LPG Gas Train | 3.13 |
| | 10' Tower LPG Gas Train (With Optional CSA Requirements) | 3.13 |
| | 10' Tower NG Gas Train..... | 3.14 |
| | 10' Tower NG Gas Train (With Optional CSA Requirements) | 3.14 |
| | 12' Tower LPG Gas Train | 3.15 |
| | 12' Tower LPG Gas Train (With Optional CSA Requirements) | 3.15 |
| | 12' Tower NG Gas Train..... | 3.16 |

| | |
|---|------|
| 12' Tower NG Gas Train (With Optional CSA Requirements) | 3.16 |
| 18' Tower Gas Train..... | 3.17 |

| | |
|---------------------|-------------|
| Burner | 3.19 |
|---------------------|-------------|

 **Operating Procedures.....4.1**

| | |
|-----------------------|------------|
| Overview | 4.1 |
|-----------------------|------------|

| | |
|------------------------------------|------------|
| Component Adjustments | 4.1 |
|------------------------------------|------------|

| | |
|---------------------------|-----|
| Air Pressure Switch | 4.1 |
|---------------------------|-----|

| | |
|-------------------------|-----|
| High Limit Switch | 4.2 |
|-------------------------|-----|

| | |
|--------------------------------------|-----|
| Variable Frequency Drive (VFD) | 4.4 |
|--------------------------------------|-----|

| | |
|---|------|
| Changing Variable Frequency Drive Parameters..... | 4.18 |
|---|------|

| | |
|--------------------------------------|-------------|
| Soft Starter Parameters | 4.19 |
|--------------------------------------|-------------|

| | |
|--|-------------|
| Changing Soft Starter Parameters..... | 4.20 |
|--|-------------|

| | |
|-------------------------------------|-------------|
| Operational Procedures | 4.22 |
|-------------------------------------|-------------|

| | |
|--------------------------|------|
| First Time Start-Up..... | 4.22 |
|--------------------------|------|

| | |
|-----------------------|------|
| Daily Shut-Down | 4.23 |
|-----------------------|------|

| | |
|----------------------|------|
| Daily Start-Up | 4.24 |
|----------------------|------|

| | |
|-------------------------------|------|
| End-of-Season Shut-Down | 4.24 |
|-------------------------------|------|

| | |
|-------------------------------------|------|
| Suggested Plenum Temperatures | 4.26 |
|-------------------------------------|------|

| | |
|-------------------------------|------|
| Suggested Discharge Rate..... | 4.26 |
|-------------------------------|------|

 **Maintenance** **5.1**

| | |
|-----------------------|------------|
| Overview | 5.1 |
|-----------------------|------------|

| | |
|--------------------------------|------------|
| Pre-Season Checks | 5.1 |
|--------------------------------|------------|

| | |
|-------------------------------------|-----|
| Grain Fill & Discharge System | 5.1 |
|-------------------------------------|-----|

| | |
|----------------------|-----|
| Fans & Burners | 5.2 |
|----------------------|-----|

| | |
|-------------------------|------------|
| Lubrication..... | 5.3 |
|-------------------------|------------|

| | |
|--------------------------------|------------|
| Seasonal Cleaning | 5.3 |
|--------------------------------|------------|

| | |
|---------------------|-----|
| Outer Screens | 5.4 |
|---------------------|-----|

| | |
|---------------------|-----|
| Inner Screens | 5.4 |
|---------------------|-----|

| | |
|--------------------------------------|------------|
| Post-Season Maintenance | 5.4 |
|--------------------------------------|------------|

 **Troubleshooting.....6.1**

| | |
|--|------------|
| Diagnosing a Dryer Shutdown | 6.1 |
|--|------------|

| | |
|-------------------------------|-----|
| Safety Circuit Overview | 6.1 |
|-------------------------------|-----|

| | |
|---------------------------------------|------------|
| Safety Circuit Schematic | 6.3 |
|---------------------------------------|------------|

| | |
|--|-----|
| 10' Tower Safety Circuit Schematic (Fault Control) | 6.3 |
|--|-----|

| | |
|--|-----|
| 12' Tower Safety Circuit Schematic (Fault Control) | 6.4 |
|--|-----|

| | |
|--|-----|
| 18' Tower Safety Circuit Schematic (Fault Control) | 6.5 |
|--|-----|

| | |
|---|-----|
| 10' Tower Safety Circuit Schematic (Human Safety) | 6.6 |
|---|-----|

| | |
|---|-----|
| 12' Tower Safety Circuit Schematic (Human Safety) | 6.7 |
|---|-----|

| | |
|---|-----|
| 18' Tower Safety Circuit Schematic (Human Safety) | 6.8 |
|---|-----|

| | |
|---------------------------------|------------|
| Customer Interface | 6.9 |
|---------------------------------|------------|

| | |
|----------------------------|-----|
| Customer Connections | 6.9 |
|----------------------------|-----|

| | |
|---|-------------|
| Variable Frequency Drive (VFD) | 6.10 |
|---|-------------|

| | |
|--------------------------------------|-------------|
| Soft Starter Fault Codes..... | 6.14 |
|--------------------------------------|-------------|

| | |
|--------------------------------------|-------------|
| Common Diagnostic Issues..... | 6.19 |
|--------------------------------------|-------------|

 **Notes** **7.1**

Introduction

This volume of the manual is intended to provide you with an overview of the construction, operation and maintenance of your Mathews Company Vacuum Cool Tower Series Grain Dryer. The information contained herein is divided into 6 sections which are: Introduction, Specifications, Equipment Overview, Operating Procedures, Maintenance and Troubleshooting.

Overview

The majority of the information in this manual applies to all Vacuum Cool Tower Series Grain Dryer, however it is important to understand that there are different configurations and options that may or may not be included on your particular machine. In most cases it is indicated where there is a feature that may not be configured on all machines with a note of "if equipped" or "optional".

Grain Drying Principles

Understanding fundamental grain drying principles is an important element of the operation of your grain dryer. As such, the following is a brief overview of the grain drying process.

Grain drying is a mass transfer process consisting of the removal of water by evaporation from the grain. In its most simplest concept, drying consists of three main components, Air, Heat and Time:

Air

The function of the air is to cool the exiting grain which also increases the temperature of the air before entering the fan. After the air enters the fan, it is further heated to the desired plenum temperature and is used to facilitate a heat and mass transfer process. As the heated air passes over the grain, the heat from the air is transferred to the grain thereby elevating the temperature of the grain (heat transfer). Similarly, as the grain is heated, the moisture of the grain will start to exit to its surroundings as the equilibrium moisture of the grain is reached. This leads to the transfer of moisture from the grain to the air (mass transfer).

Heat

The accurate control of this heating process is what makes the equipment energy efficient. As the ambient conditions (temperature and relative humidity) change, as well as the desired plenum setpoint, the gas control system will respond to opening or closing to allow more or less fuel to flow to the burner.

Time

The time element of grain drying refers to the time the grain is spent inside the dryer. The time that the grain is exposed to the heated air determines how much moisture is driven out of the grain. The longer the exposure, more moisture removal occurs. As such, the best method for controlling the amount of moisture removal in the grain is to increase or decrease the grain's retention time by increasing or decreasing the discharge sweep speed. The slower the sweep system operates, the longer the grain is exposed to the heated air and the moisture removal is increased. The faster the sweep system operates, the shorter the grain is exposed to the heated air and the moisture removal is decreased.



The easiest way to keep good grain quality and accurate control is to keep heat and air consistent while varying only grain retention time, which has proven to be the most common and efficient way to dry grain.

Owner / Operator Notes

Before operating your grain dryer, it is strongly encouraged that you read the contents of this Operations Manual as well as Volume 2 - Pinnacle 20|20 Controls Manual. It will be important for you to become familiar with the controls, adjustments and settings required to obtain efficient operation.

To keep your dryer operating at its peak efficiency, it should be cleaned, lubricated, belts tensioned, ignition system checked, and the fill/takeaway in good operating condition. Refer to the Maintenance Section to understand the required maintenance and suggested intervals. The Pre-Season check can be made when the dryer is empty. Any necessary repairs or adjustments should be completed so that the dryer will be ready to operate before your drying season begins

Warranty Registration

It is important to send in your warranty registration card as soon as your new grain dryer is delivered. Not only does the card validate your warranty, but it also assists Mathews Company in disseminating information particular to your dryer model.

Model / Serial Number / Specifications

The model and serial number of your Mathews Company continuous flow grain dryer are stamped on plates located on the base of the dryer as shown:



Specifications for the machine will be located on the nameplate which is located on the inside door of the High Voltage Cabinet as well as on the inside of the Remote Cabinet. A sample nameplate is shown below:

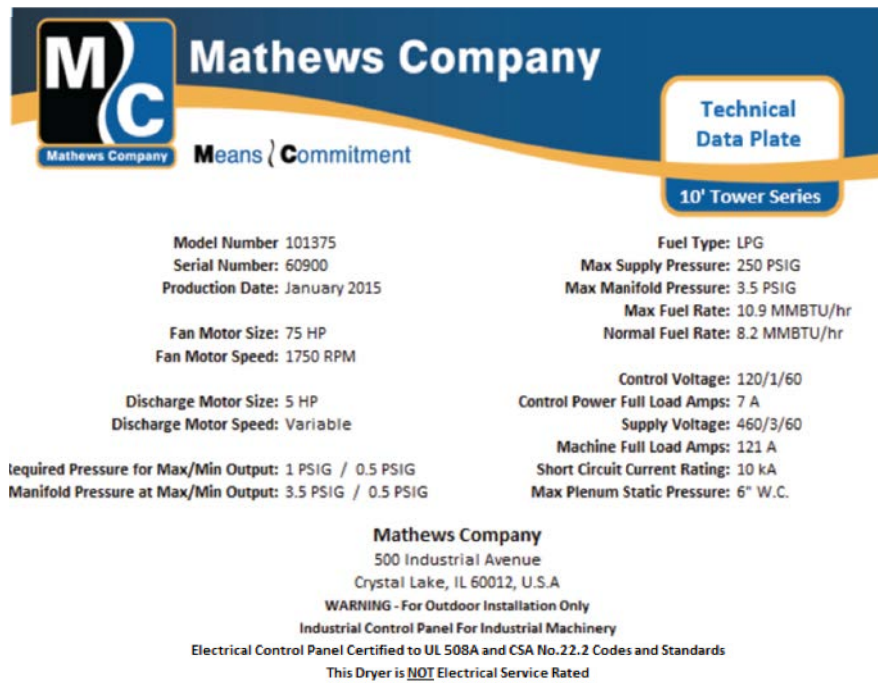

Safety

While operating or performing maintenance on your machine, it is important to make safety a top priority. Be sure to read and understand the operations manual before attempting to operate the dryer. The following list of best practices should be followed to help ensure safe operation:

1. Keep ALL guards, access doors, covers, safety decals, and safety devices in place and securely fastened. Never operate the dryer while guards are removed.
2. Keep all untrained personnel away from system components and control panels at all times.
3. Never attempt to operate the unit by jumping or otherwise bypassing any safety devices.
4. Always open the main power supply disconnect switch and lock it in the open position with an approved lockout device prior to performing any service or maintenance work on the fan or burner unit.
5. Lock out power before removing guards, access doors, and covers.
6. Keep hands, feet and clothing away from all rotating parts.
7. Electrical repairs should be performed by trained and qualified personnel only. Failure to follow safe electrical procedures can result in serious injury.
8. If it should become necessary to perform checks on system components or high voltage test with energized circuits, proceed with extreme caution and follow all established safety practices.
9. Routinely check for any gas leaks.
10. Do not allow children or bystanders to be near the grain dryer or grain handling machinery while it is operating.
11. Do not operate the grain dryer without all safety shields in place and secure.



Lock-out / Tag-out Requirements

The purpose of a lock-out / tag-out procedure is to prevent injury and/or death to personnel by requiring that certain precautions be taken before servicing or repairing equipment. This includes shutting off and locking-out the electrical power source of the equipment. A standard Lock-out / Tag-out program is explained as follows:

1. All maintenance personnel are issued a suitable lock (or locks) that is durable. The lock has the individual's name and other identification on it. Each worker must have his/her own lock and the only key to that lock. In addition, locks can be color coded to indicate different shifts or types of services.
2. Each person who will be working on the machinery should put a lock on the machine's lockout device(s). Each lock must remain on the machine until the work is completed. Only the individual who placed the lock should remove his/her lock.
3. Check to be sure that no one is operating the machinery before turning off the power. The machine operator must be informed before the power is turned off. Sudden loss of power could cause an accident.
4. Any mechanism under load or pressure, such as springs, should be released and blocked.
5. All energy sources that could activate the machine must be locked-out.
6. The main valve or main electrical disconnect must be tested to be sure that the power to the machine is off.
7. Electrical circuits must be checked by qualified persons with proper and calibrated electrical testing equipment. An electrical failure could energize the equipment, even if the switch is in the OFF position. Stored energy in electrical capacitors should be safely discharged.
8. Return disconnects and operating controls to the OFF position after each test.
9. Attach accident prevention tags. The tags will give the reason for placing the tag, the name of the person placing the tag, how he/she may be contacted, and the date and time the tag was placed.

The following are some images of lock out tag out material that can be used for locking out the work area.





Blocks

Suitable blocks are another important safety device for making a piece of equipment safe to be repaired or serviced. Blocks must be placed under raised dies, lifts, or any equipment that might inadvertently move by sliding, falling, or rolling.

Blocks, special brackets, or special stands, such as those commonly used under raised vehicles, must be available at all times. Another form of blocking is the placement of a blind. A blind is a disk of metal placed in a pipe to ensure that no air or other substance will pass through that point if the system is accidentally activated.

Before installing blinds or blocks, bleed down steam, air or hydraulic lines to get rid of any pressure. Coiled springs, spring loaded devices or suspended loads must also be released so that their stored energy will not result in inadvertent movement.

Fire Emergency

In the event of a fire, remain calm and follow the guidelines presented below to ensure the situation is dealt with properly. As a precaution, a fire extinguisher should be located at or near the dryer.

1. Shut down the entire drying operation, including grain flow into and out of the dryer by pressing the emergency stop button. Never transfer grain from the dryer into the elevator or storage if a fire is known or suspected.
2. Shut off the electrical and fuel supply to the dryer.
3. Do not try to cool the fire by running the fans; fire needs Oxygen and the air will only make the situation worse.
4. Locate the area of the fire.
5. If the fire can be extinguished with a fire extinguisher, water hose, or by removing the burning material, this should be done right away. Watch the dryer closely for another fire after one has occurred.
6. If the fire seems to be getting out of control, call the fire department.
7. Emergency discharge slide gates at the bottom of each column as well as easy access gates located near the discharge area permit fast dumping of each individual column. Avoid chopping holes in the dryer if possible.



Specifications

10' Tower Specifications

| Model | 10530 | 10740 | 10950 | 101160 | 101375 |
|---|-----------|-----------|-----------|-----------|-----------|
| Total Height | 34'-5" | 42'-3" | 50'-4" | 58'-5" | 66'-5" |
| Outside Column Diameter | 9'-9" | 9'-9" | 9'-9" | 9'-9" | 9'-9" |
| Grain Column Thickness | 12" | 12" | 12" | 12" | 12" |
| Heat Section Holding Capacity (bu) | 331 | 442 | 596 | 740 | 853 |
| Cool Section Holding Capacity (bu) | 110 | 176 | 199 | 232 | 296 |
| Wet Hipper Holding Capacity (bu) | 140 | 140 | 140 | 140 | 140 |
| Total Holding Capacity (bu) | 581 | 758 | 935 | 1,112 | 1,289 |
| Shipping Weight (lbs) | 10,700 | 12,700 | 14,700 | 16,700 | 18,600 |
| Number of Outside Walkways | 1 | 1 | 2 | 3 | 3 |
| Grain Exchanger | N/A | N/A | Optional | Optional | Optional |
| Fan Qty / Size | 1 X 30 HP | 1 X 40 HP | 1 X 50 HP | 1 X 60 HP | 1 X 75 HP |
| Fan Airflow (CFM) ³ | 26,700 | 35,100 | 47,200 | 59,500 | 64,700 |
| Electrical Load (208V/3ph/60Hz) | 134 Amps | 167 Amps | 196 Amps | 224 Amps | 266 Amps |
| Electrical Load (230V/3ph/60Hz) | 120 Amps | 152 Amps | 176 Amps | 202 Amps | 241 Amps |
| Electrical Load (460V/3ph/60Hz) | 59 Amps | 76 Amps | 89 Amps | 102 Amps | 121 Amps |
| Average Operating Burner Capacity (MMBTU/hr) ⁴ | 3.37 | 4.41 | 5.96 | 7.26 | 8.04 |
| Max Operating Burner Capacity (MMBTU/hr) ⁵ | 4.49 | 5.88 | 7.95 | 9.68 | 10.89 |
| Max Burner Nameplate Capacity (MMBTU/hr) | 8.50 | 9.50 | 10.50 | 12.50 | 12.50 |



10530 Dimensions

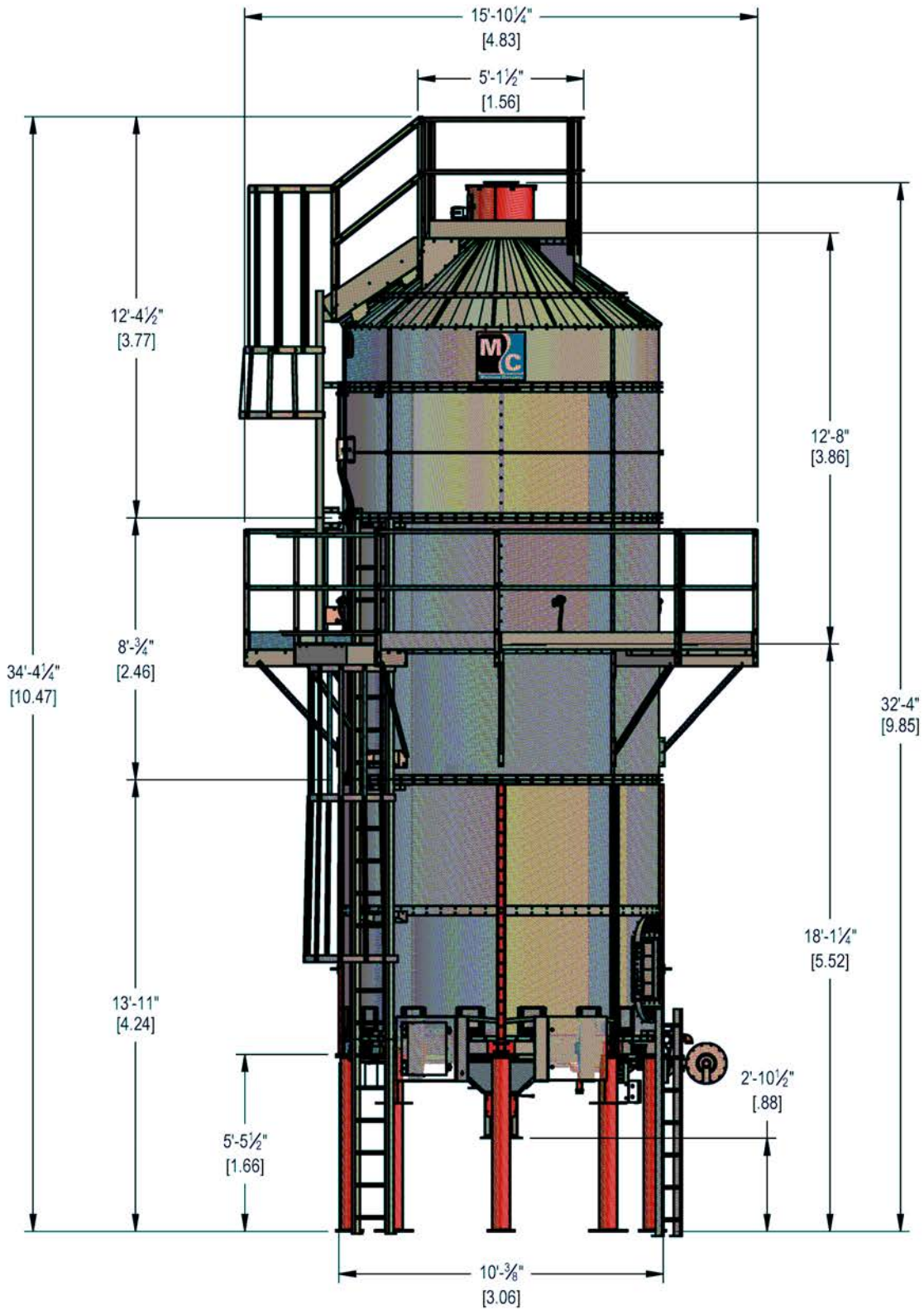

10530 TOWER



10740 Dimensions (Shown With Optional Additional Walkway)

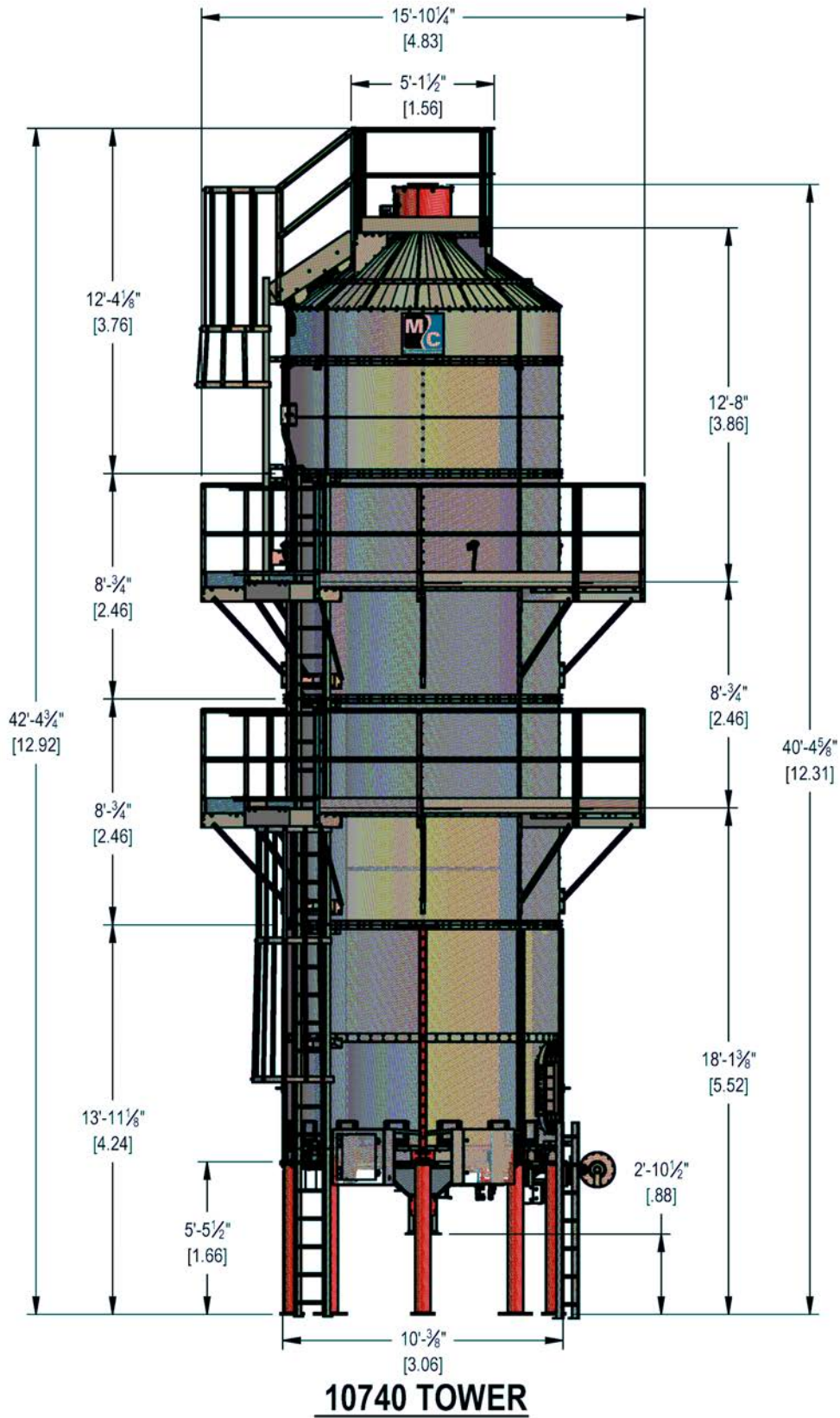

10950 Dimensions

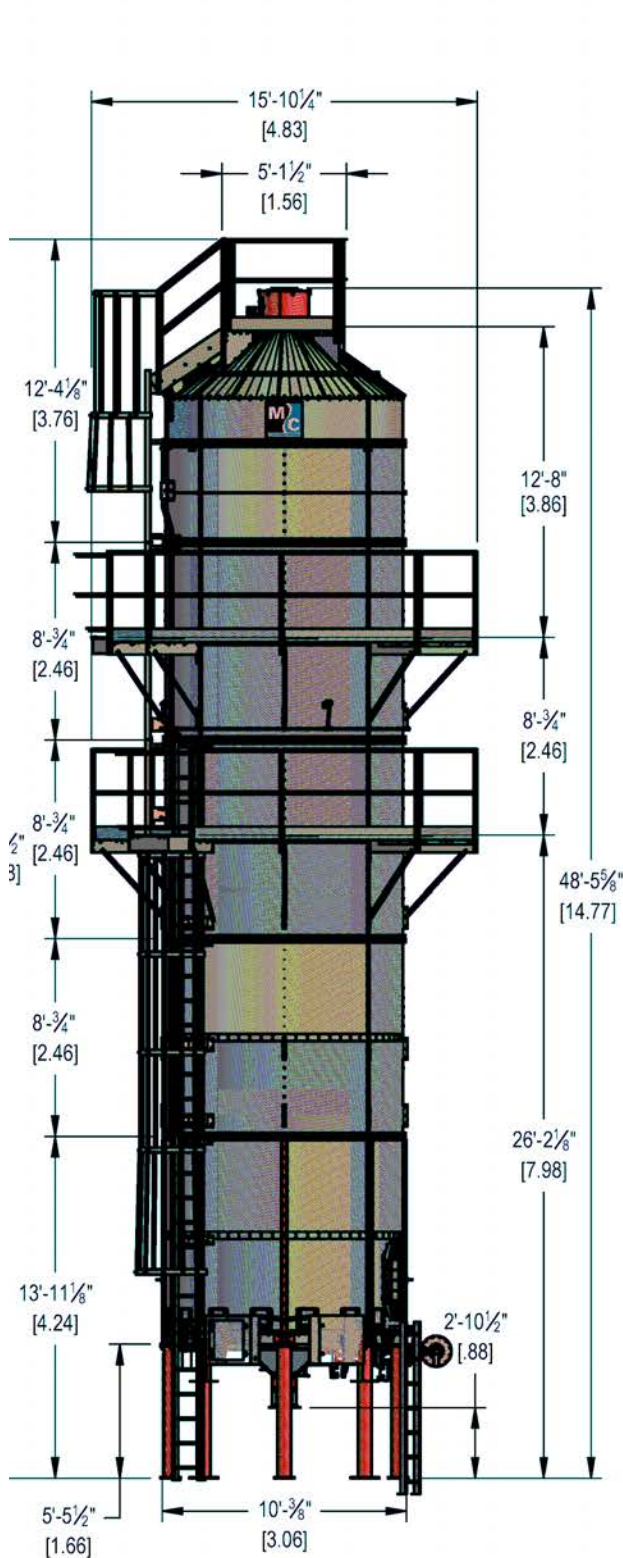

10950 TOWER - W/O G.E.

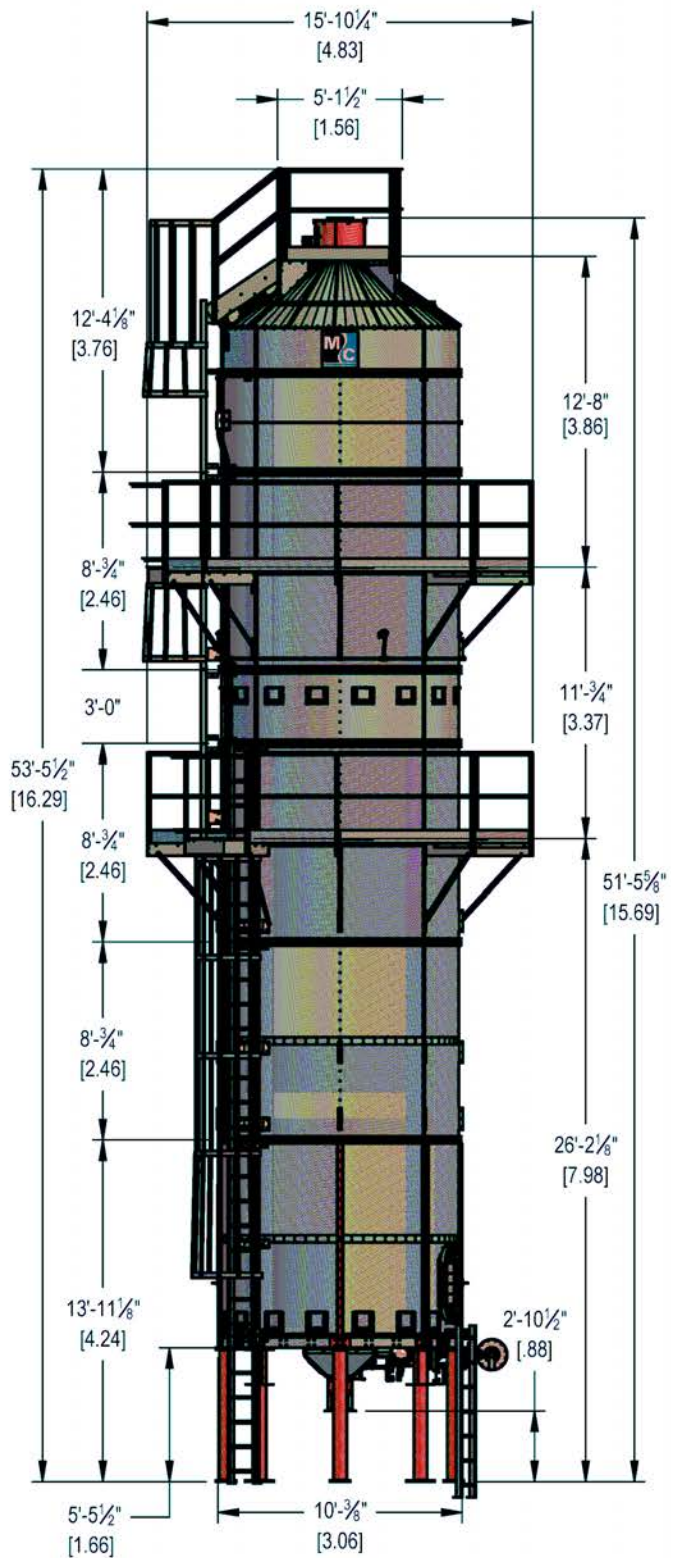

10950 TOWER - W/ G.E.



101160 Dimensions

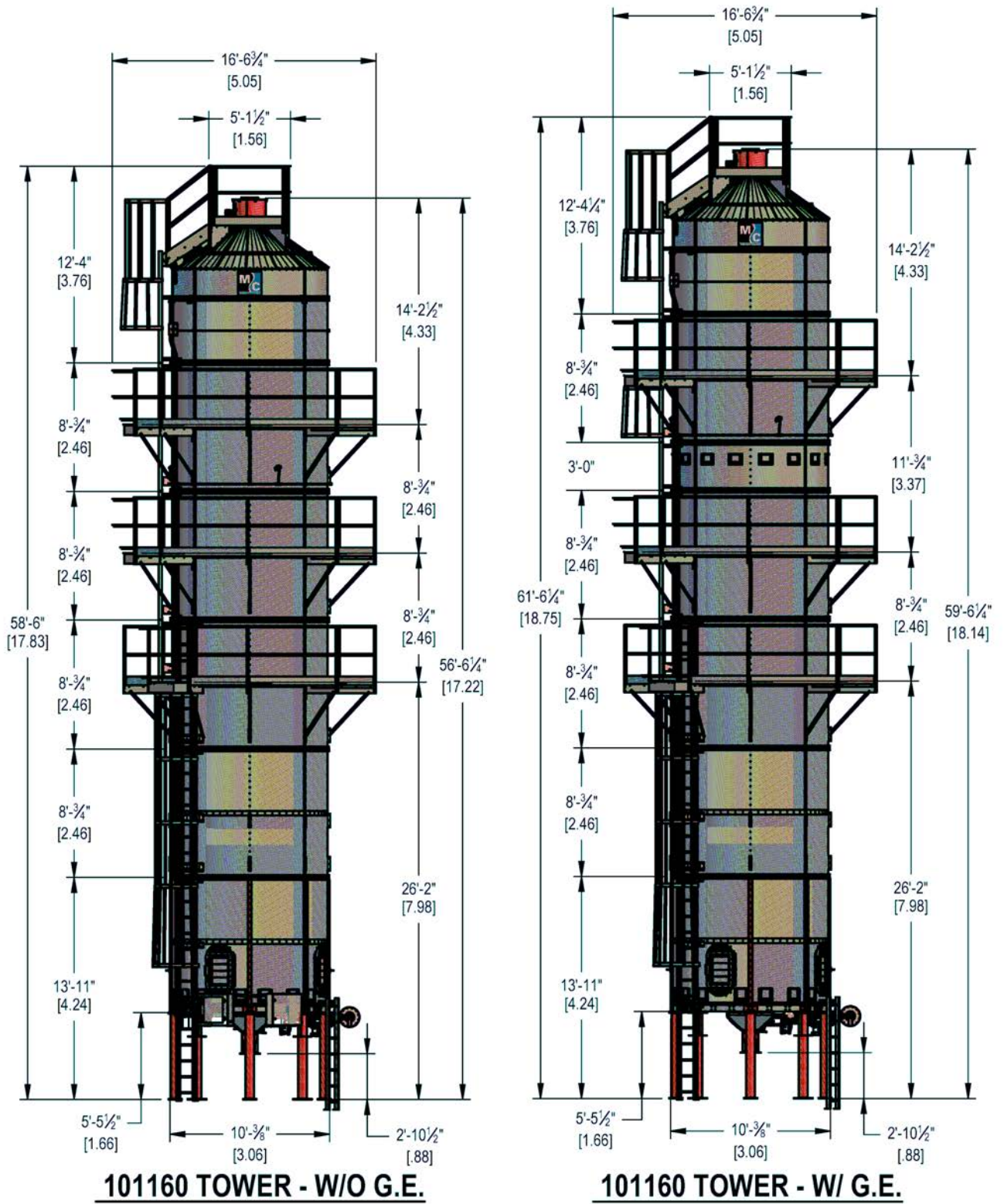

101375 Dimensions

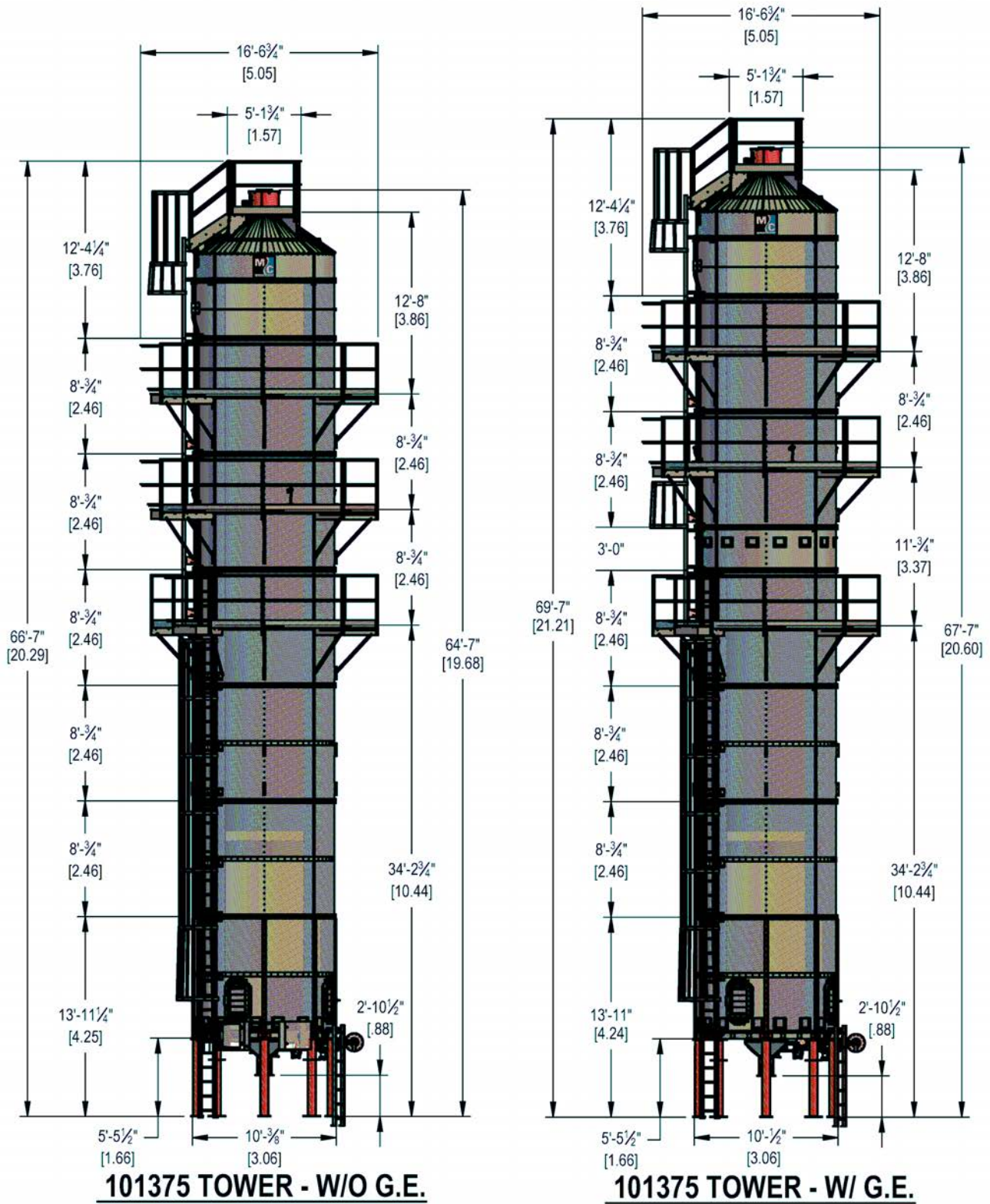

12' Tower Specifications

| Model | 12-20-100 | 12-24-125 | 12-28-150 |
|------------------------------------|-----------|-----------|-----------|
| Heat Section Holding Capacity (bu) | 1024 | 1293 | 1535 |
| Cool Section Holding Capacity (bu) | 391 | 444 | 525 |
| Additional Holding Capacity (bu) | 335 | 335 | 335 |
| Total Height | 74'-11" | 87'-0" | 99'-2" |
| Fill Height | 71'-11" | 84'-0" | 96'-2" |
| Diameter | 11'-8" | 11'-8" | 11'-8" |
| Grain Column Thickness | 12" | 12" | 12" |
| Number of External Walkways | 3 | 4 | 5 |
| Max Burner Capacity (MMBTU/hr) | 15.7 | 18.9 | 22.1 |
| Average Burner Capacity (MMBTU/hr) | 11.7 | 14.2 | 16.5 |
| Fan Airflow (SCFM) | 90,000 | 109,000 | 128,000 |
| Number of Fans | 1 | 1 | 1 |
| Fan Motor Size (HP) | 100 | 125 | 150 |



12-20-100 Dimensions

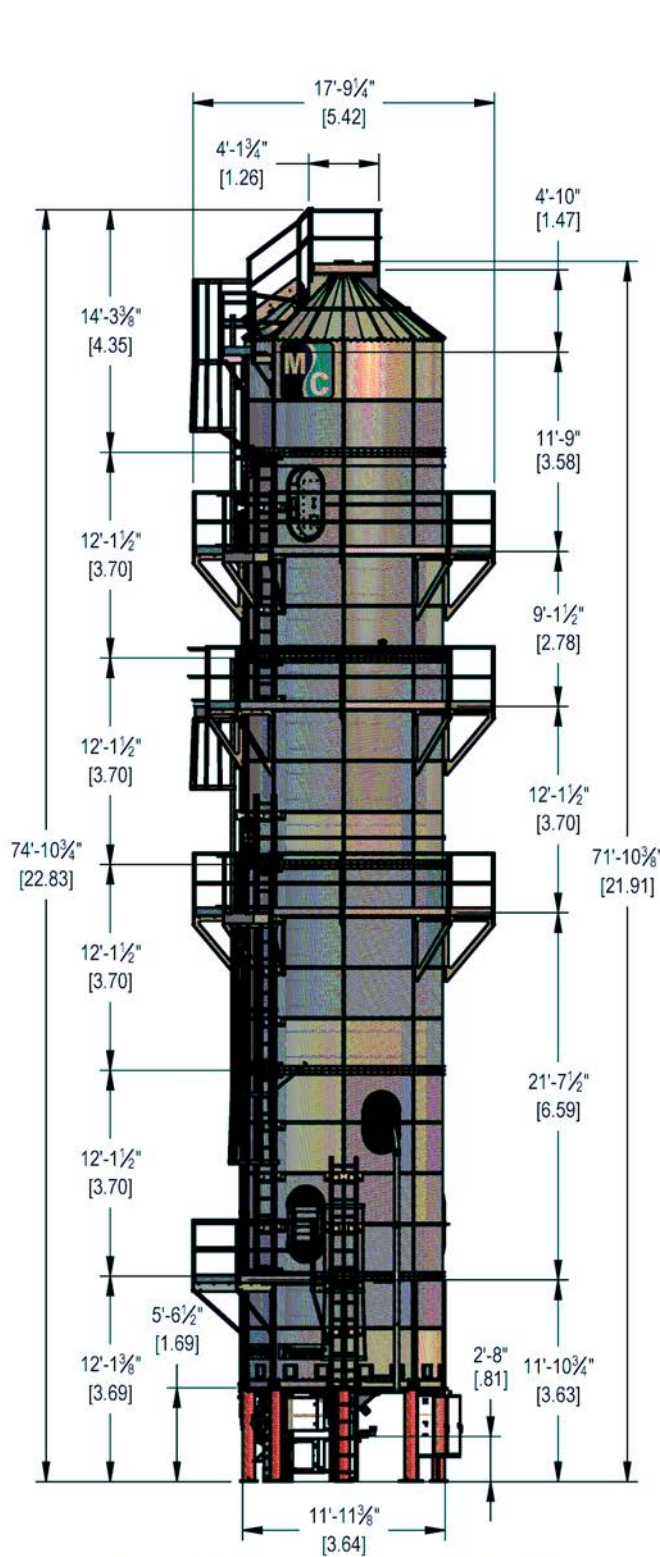

12-20-100 TOWER-W/O G.E.

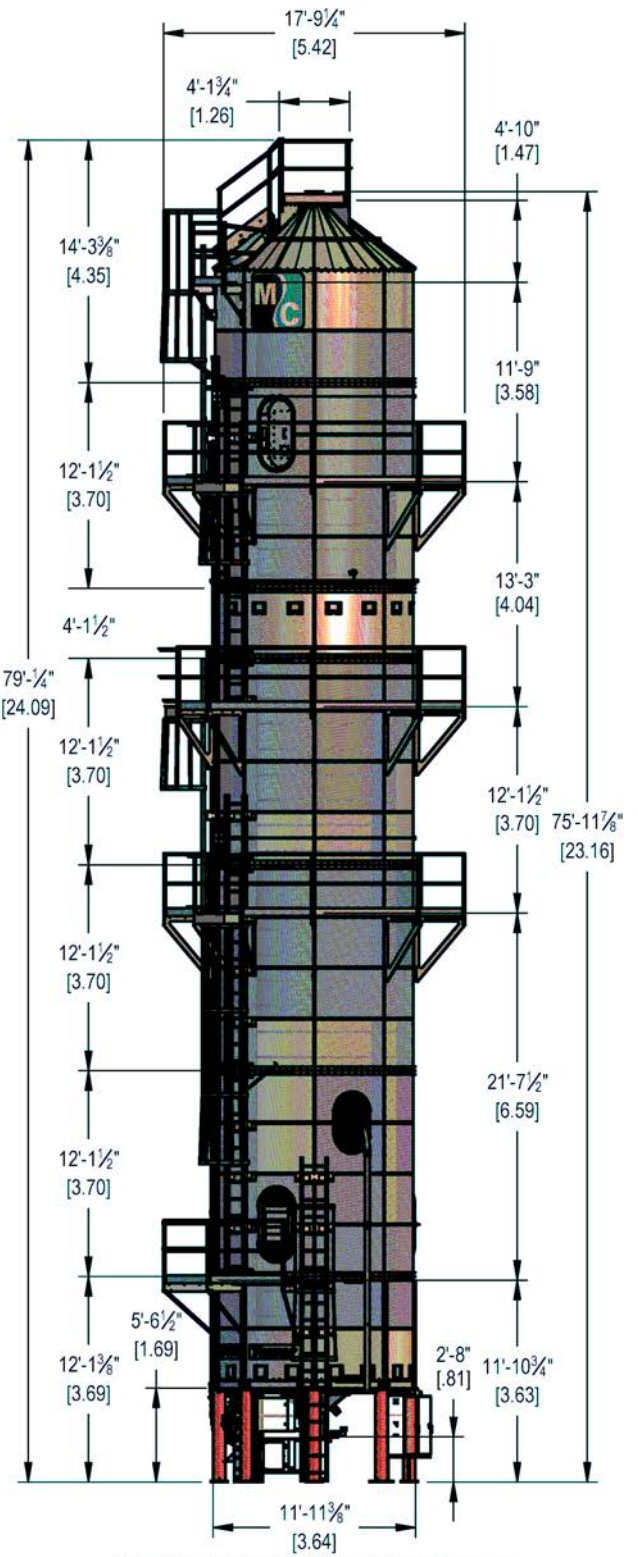

12-20-100 TOWER-W/ G.E.

12-24-125 Dimensions

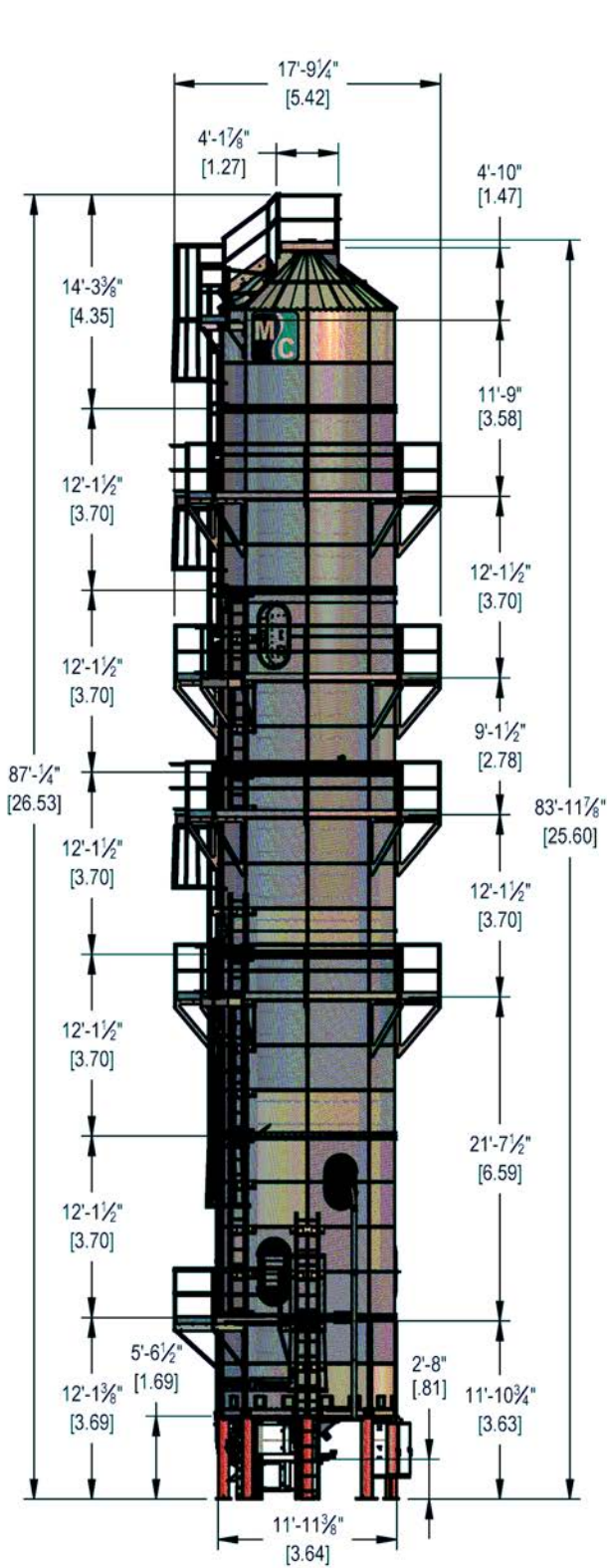

12-24-125 TOWER-W/O G.E.

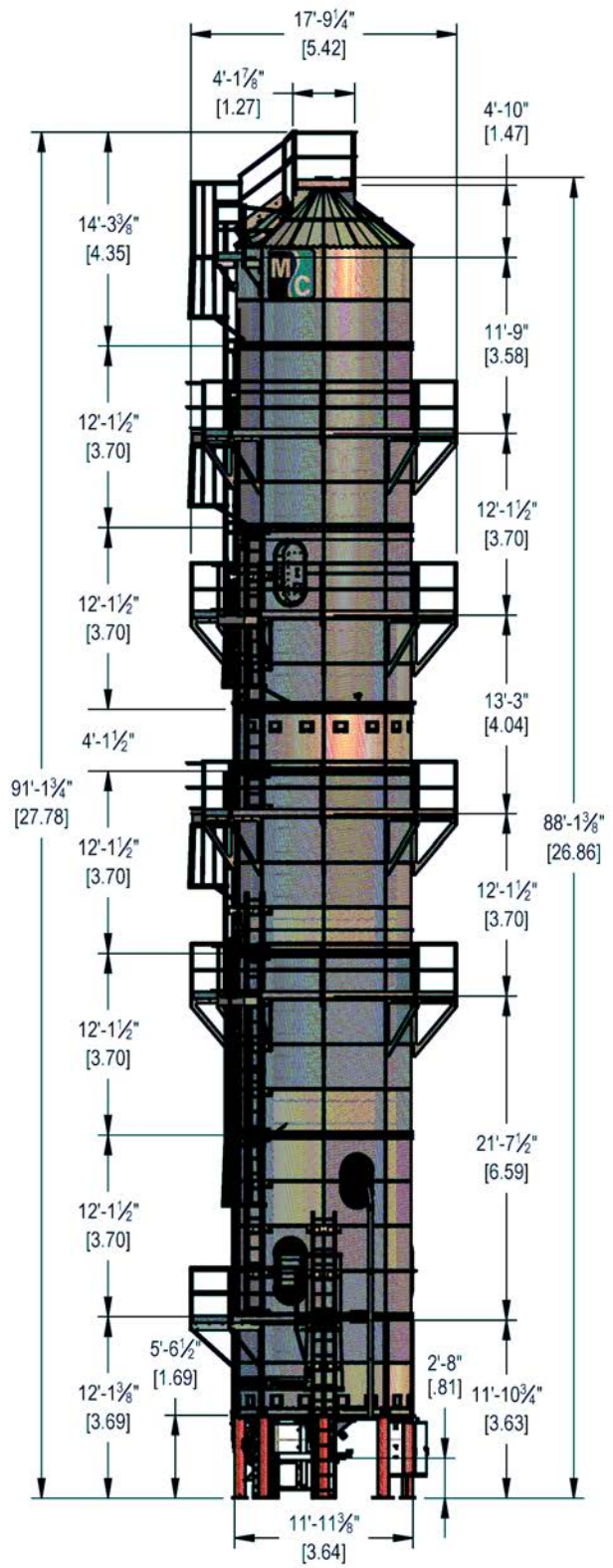

12-24-125 TOWER-W/ G.E.

12-28-150 Dimensions

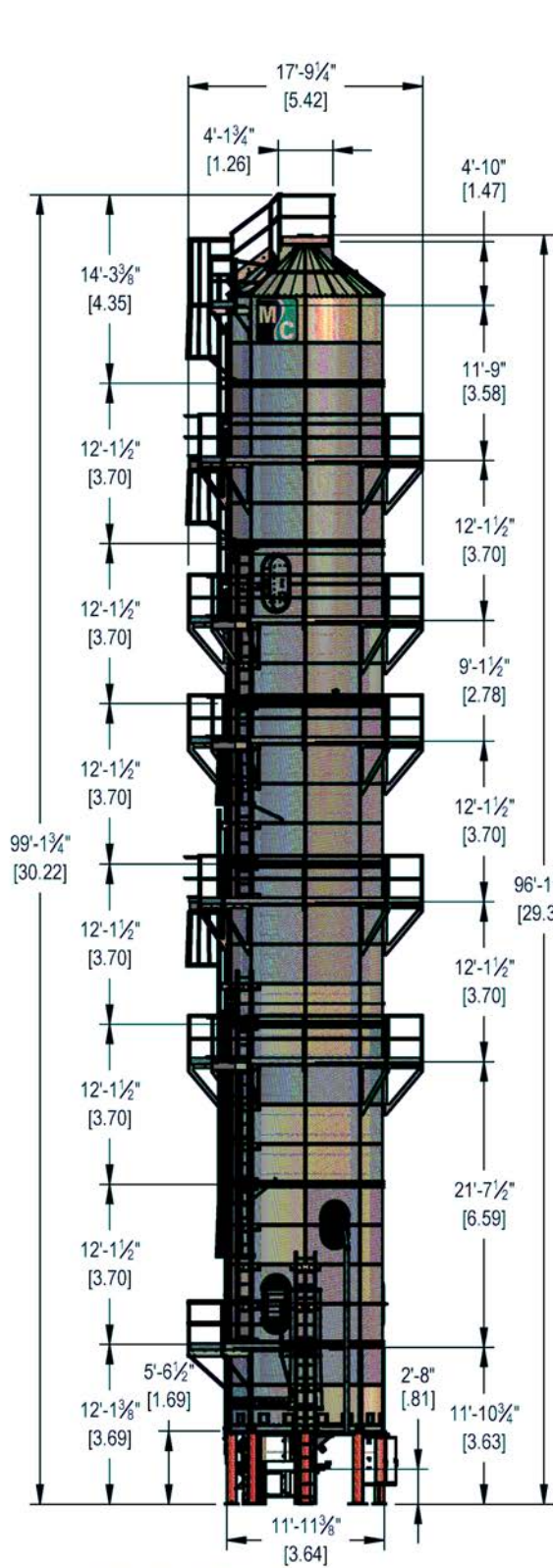

12-28-150 TOWER-W/O G.E.

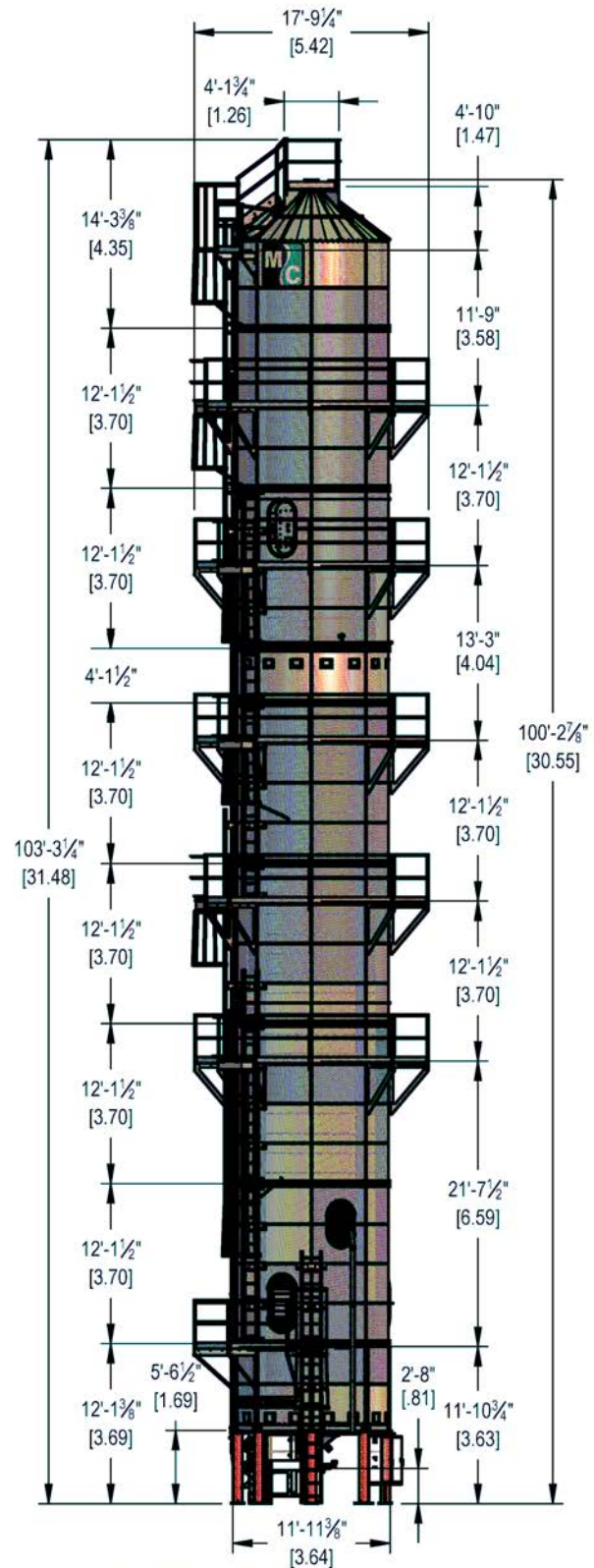

12-28-150 TOWER-W/ G.E.



18' Tower Specifications

| Model | 3000 | 3500 | 4000 | 4800 |
|------------------------------------|---------|---------|---------|---------|
| Heat Section Holding Capacity (bu) | 2,092 | 2,343 | 2,5494 | 2,888 |
| Cool Section Holding Capacity (bu) | 700 | 700 | 826 | 826 |
| Additional Holding Capacity (bu) | 919 | 919 | 919 | 919 |
| Total Holding Capacity (bu) | 3,711 | 3,962 | 4,339 | 4,633 |
| Total Height | 83'-8" | 89'-8" | 98'-8" | 103'-8" |
| Diameter | 17'-6" | 17'-6" | 17'-6" | 17'-6" |
| Grain Column Thickness | 12" | 12" | 12" | 12" |
| Number of External Walkways | 2 | 3 | 3 | 3 |
| Max Burner capacity (MMBTU/hr) | 33.7 | 36.3 | 42.5 | 44.2 |
| Average Burner Capacity (MMBTU/hr) | 20.2 | 21.8 | 25.5 | 26.5 |
| Fan Airflow (SCFM) | 153,000 | 156,000 | 193,000 | 200,000 |
| Number of Fans | 3 | 3 | 3 | 3 |
| Fan Motor Size (HP) | 50 | 60 | 75 | 75 |



3000 Dimensions

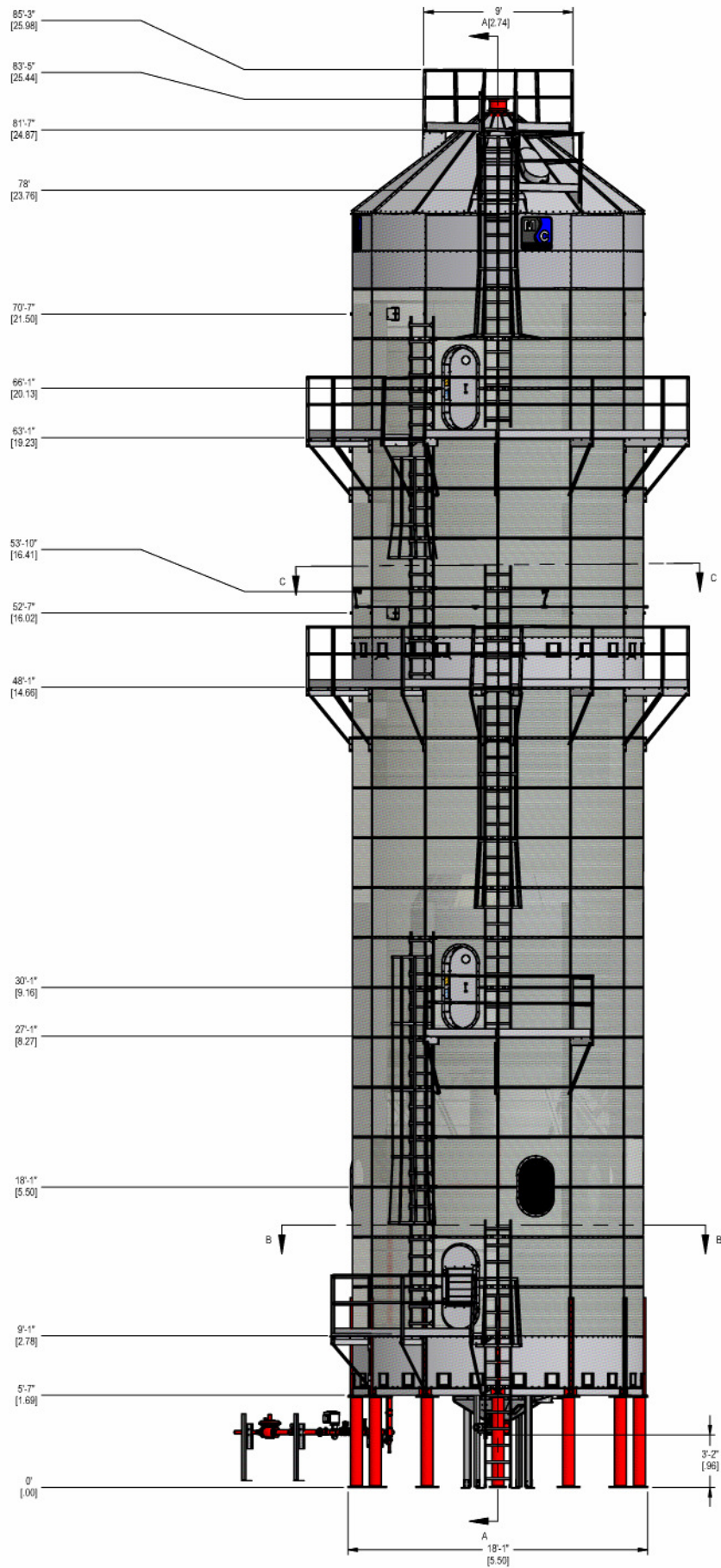

3500 Dimensions

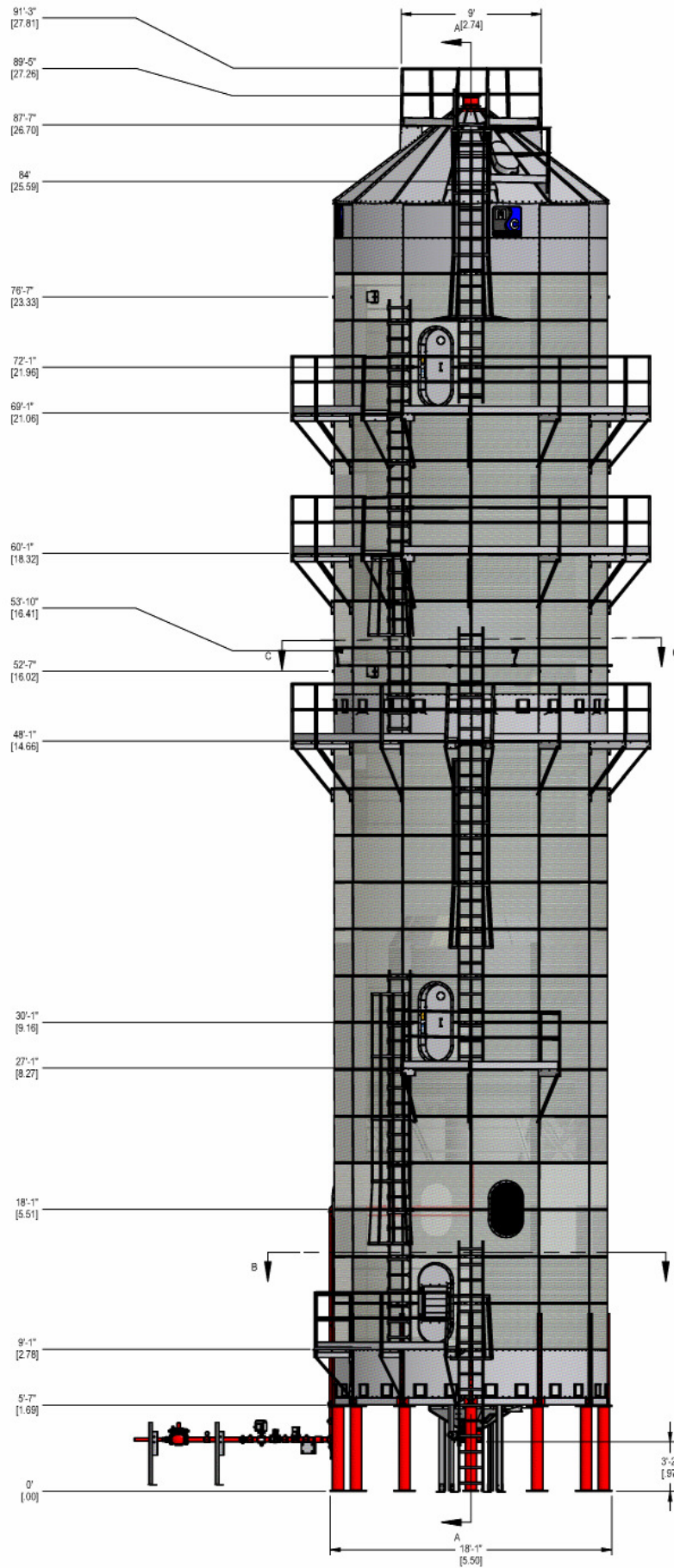

4000 Dimensions

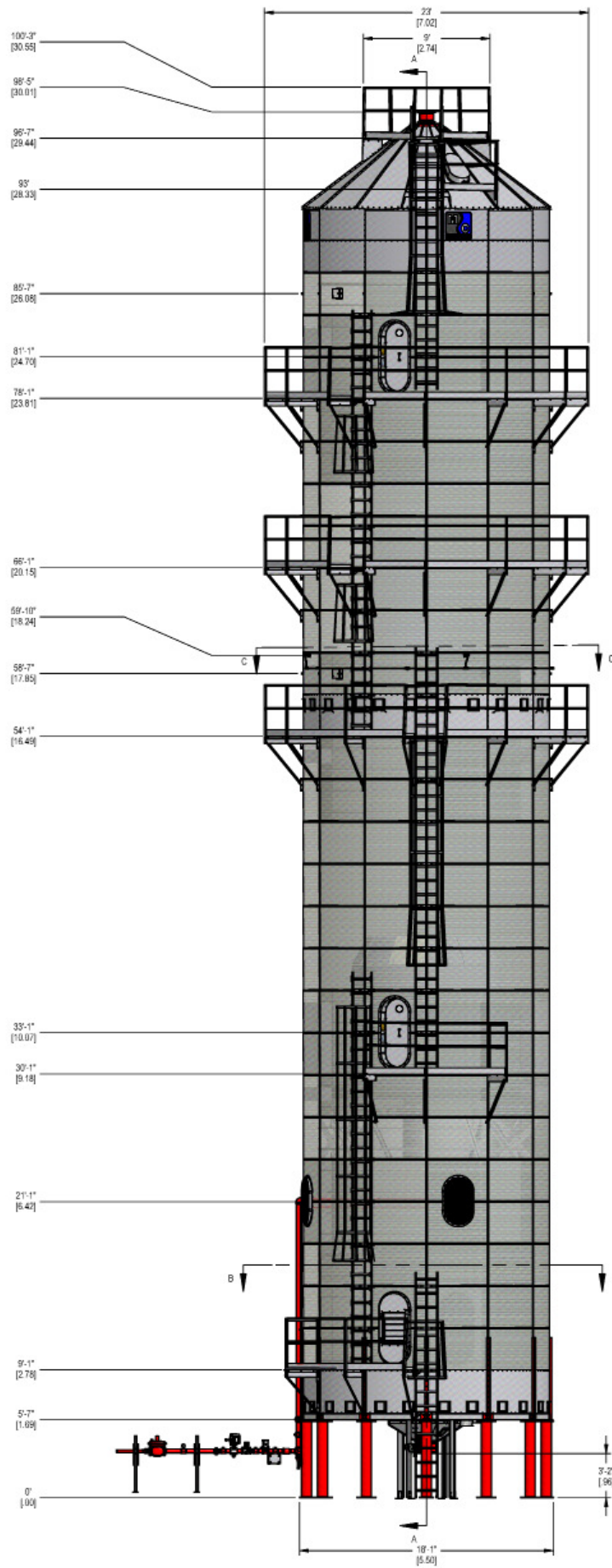

4800 Dimensions

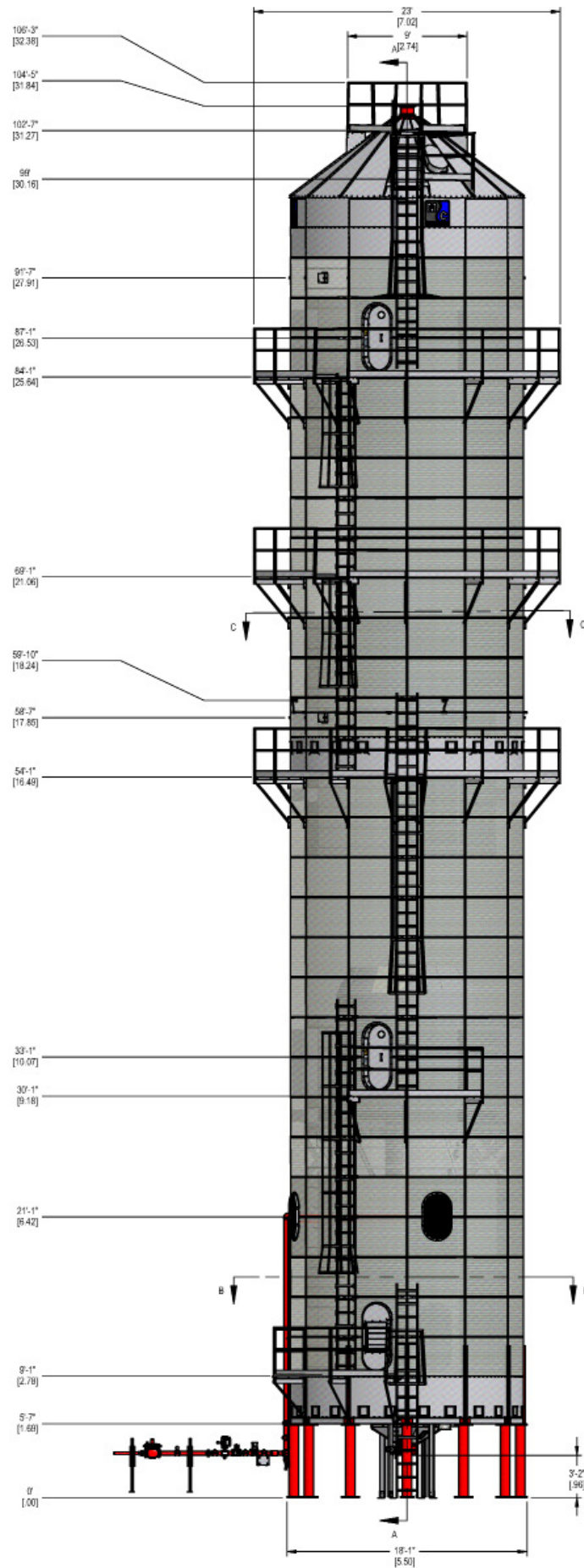



Equipment Overview

The Equipment Overview section will help identify parts of the dryer and briefly explain their function. The images will physically show you what the component(s) look like and the description following will state their purpose.

Main Dryer Components

The following rendered image shows an overall view of the dryer with some of the main components highlighted. The pages following will explain these components or assemblies more in depth as well as explain the function of any associated parts.

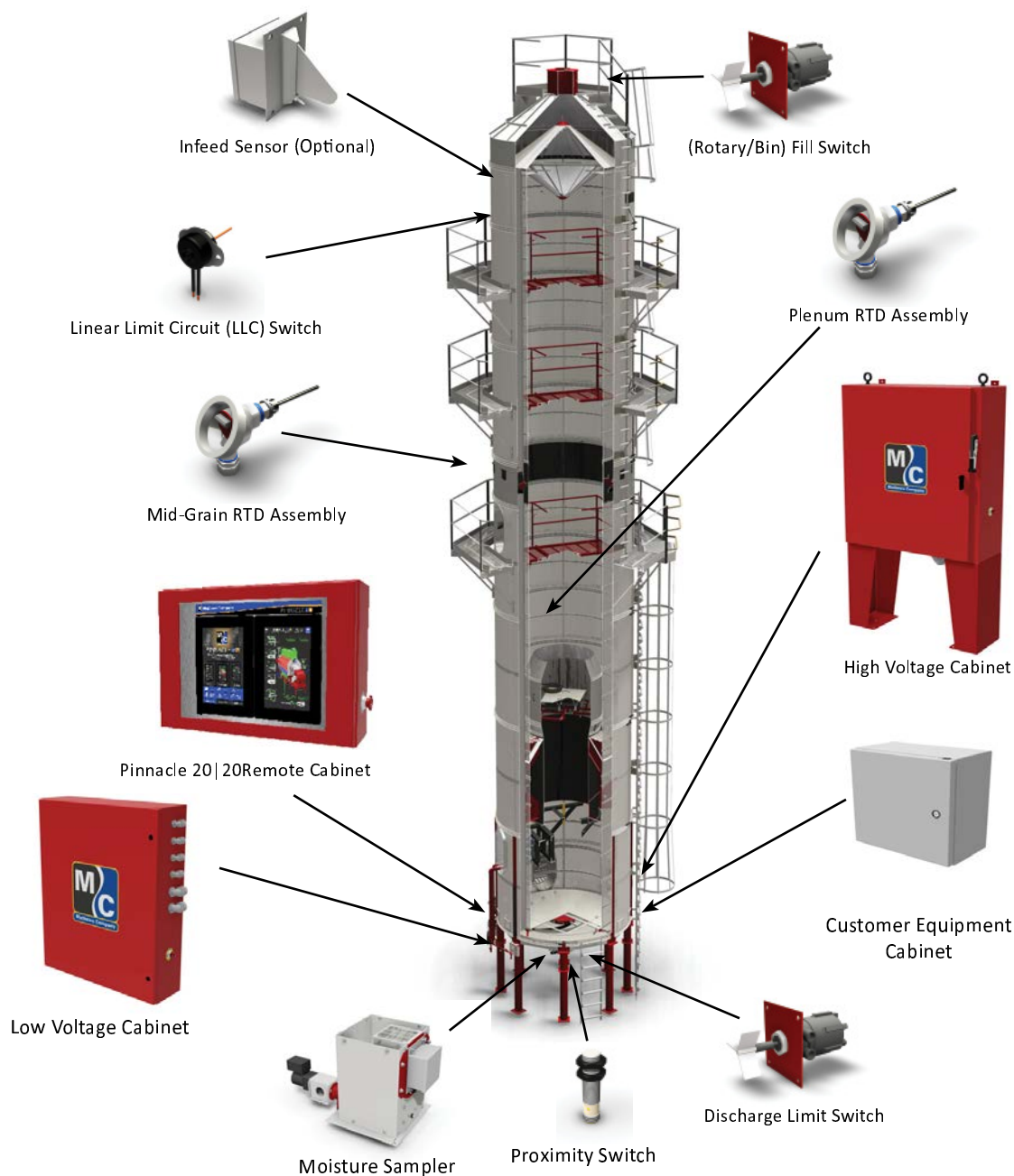



Rotary (Bin) Fill Switch

The Rotary Fill Switch is located in the wet hopper and is powered by 24V. The switch is motorized and will rotate a paddle until wet grain comes in contact with the paddle. Once this happens, grain stops the rotation and proves the level of grain in the hopper.



Plenum RTD

The Plenum RTD (Resistance Temperature Device) is a temperature sensing device located in the plenum used to send a signal to the PLC to establish and maintain plenum temperature.



Mid-Grain RTD Assembly

The two Mid-Grain RTD (Resistance Temperature Device) Assemblies are located around the perimeter of the dryer and are used to detect the temperature of the grain in the column. Each of these two RTD assemblies is equipped with a 4-20mA transmitter which provides an analog input signal sent to the PLC.



Proximity Switch

The Proximity Switch is used to detect the rotation of the discharge metering system by sensing the proximity of a detector on the discharge metering shaft. If the rotation of the shaft goes undetected for a set duration of time, the machine will be shutdown.



Linear Limit Circuit (LLC) Switch

The Linear Limit Circuit (LLC) Switch is wrapped around the screen section of the dryer, as well as the inside of the dryer, directly below the sloped floor, and provides a safety shutdown when over-temperature is detected.



Discharge Limit Switch

The purpose of this switch is to detect a discharge grain overload condition that may be a result of failed takeaway equipment. The switch is motorized and will rotate a paddle until grain comes in contact with the paddle. Once this happens, grain stops the rotation and proves the level of grain which would imply an overload conditions exists; in doing so, the safety circuit is opened and the dryer is shutdown.



Infeed DM510 Moisture Sensor (Optional)

The infeed moisture sensor is mandatory for AccuDry grain dryers, and optional for TruDry grain dryers. This sensor monitors incoming grain in real-time so that the AccuDry prediction model can react to incoming grain moisture changes. On an optional TruDry grain dryer, this will only display on the main screen, and will not affect the operation of the grain dryer.

High Voltage Cabinet

The High Voltage Cabinet contains all of the motor starters and protectors, main power disconnect, VFD, and other associated electrical hardware.

10' Tower High Voltage Cabinet

The 10' Tower High Voltage Cabinet has two main variations which include a direct start and a soft start option:

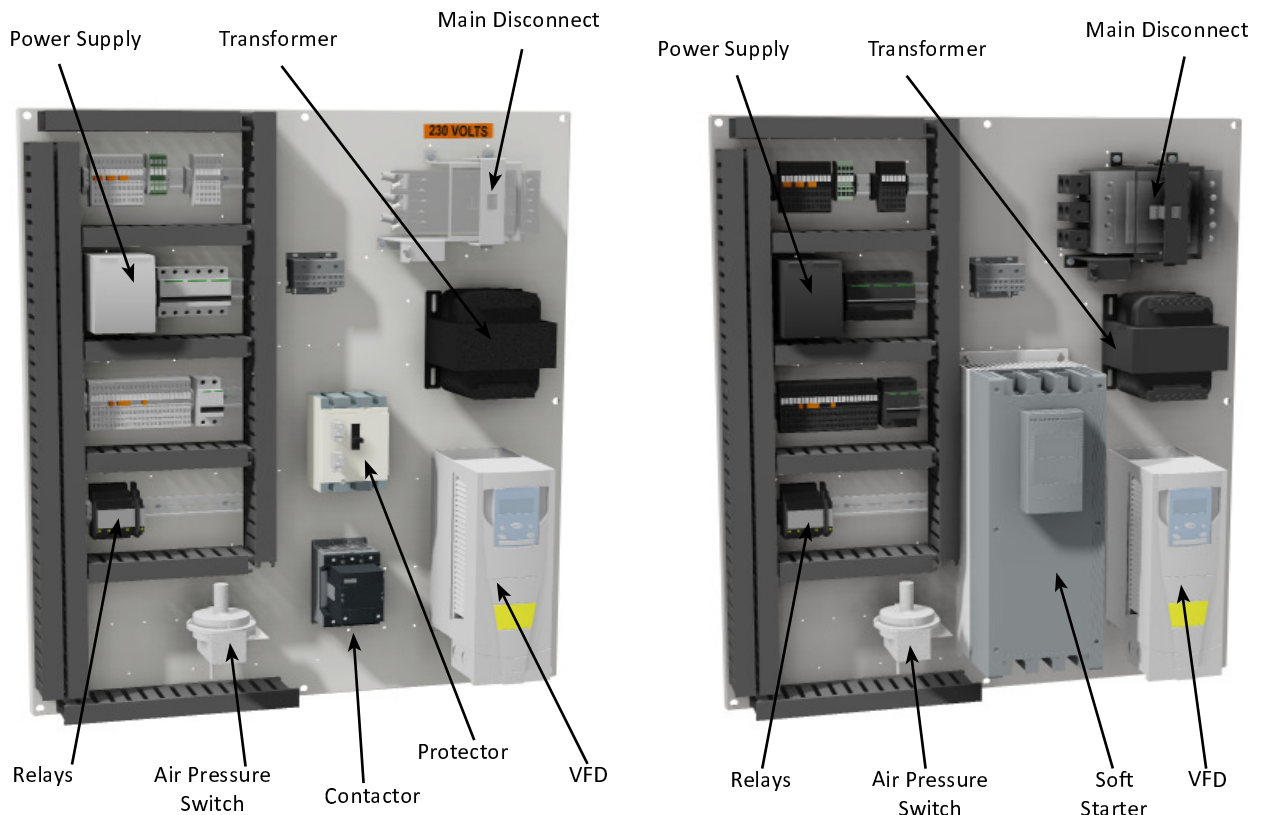
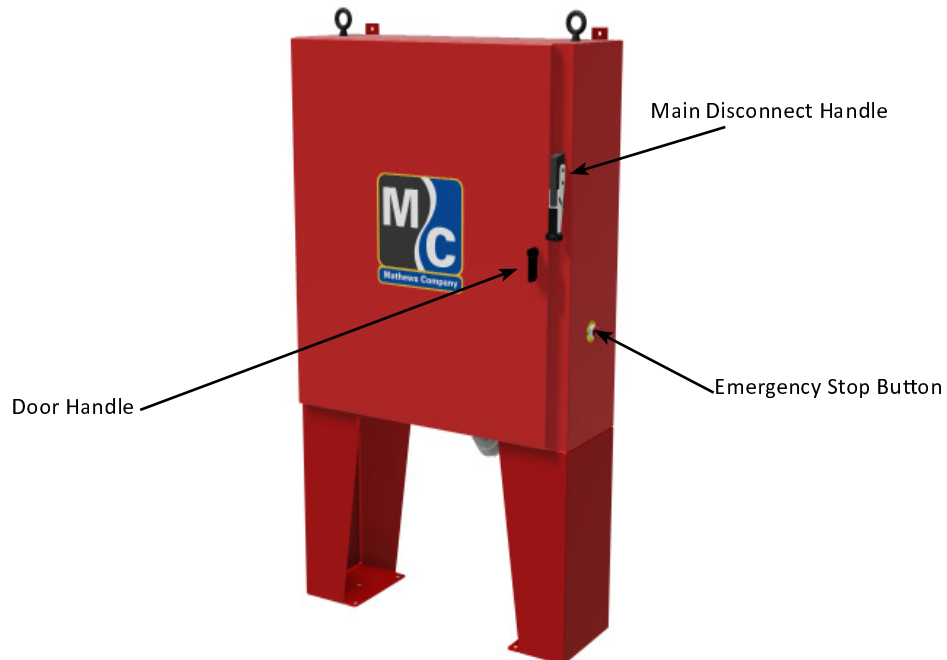

12' Tower High Voltage Cabinet

The 12' Tower High Voltage Cabinet has two main variations which include a direct start and a soft start option. The subpanel shown below is the soft start option.

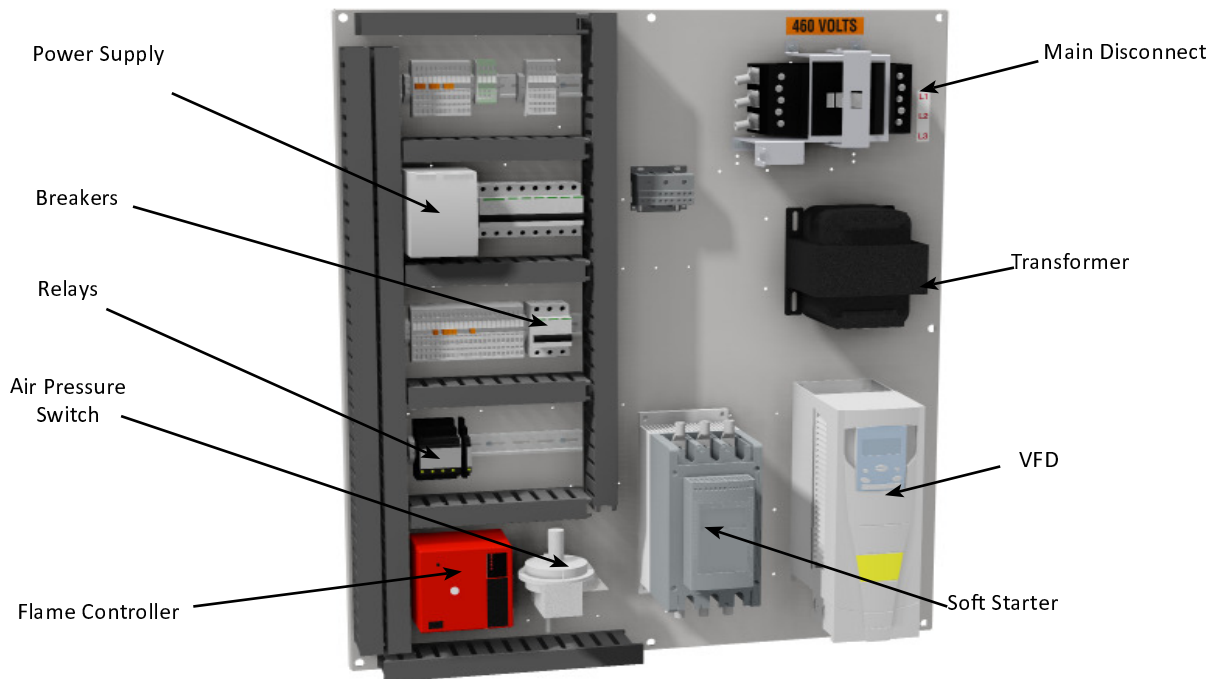
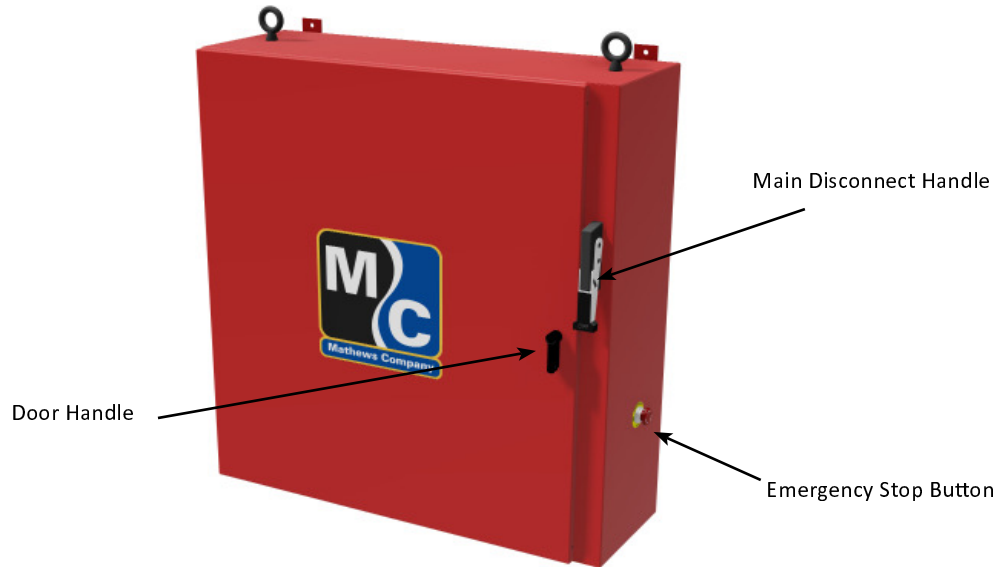

18' Tower High Voltage Cabinet

The 18' Tower High Voltage Cabinet features a tri-start motor control system:

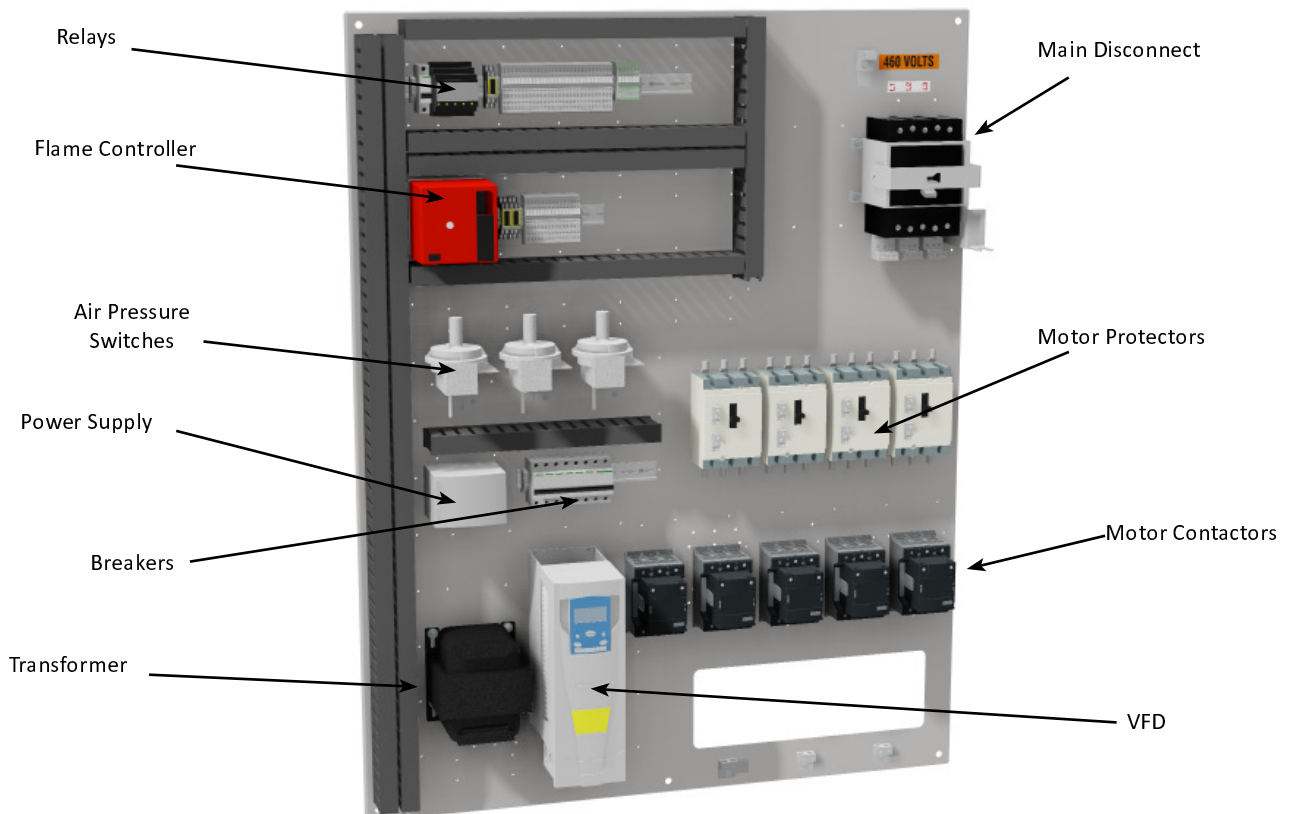
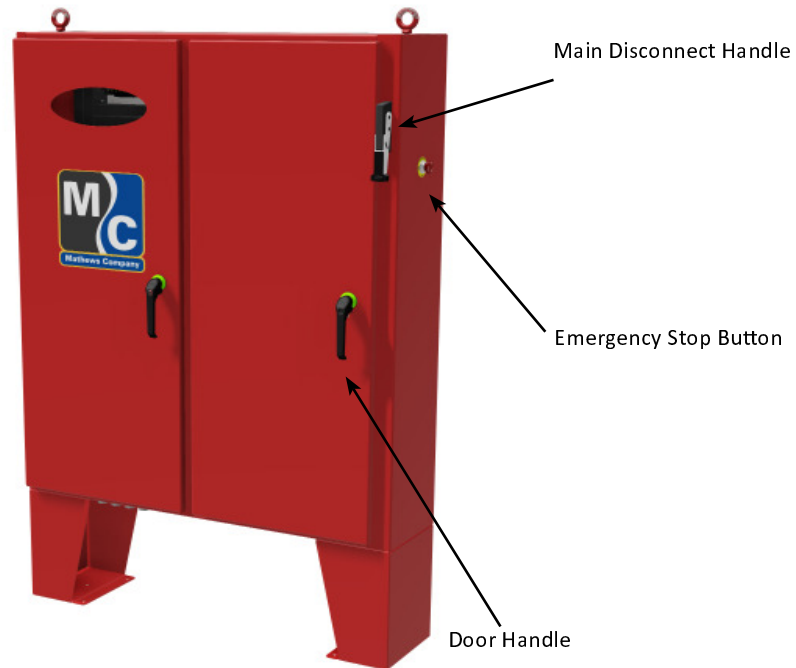



Air Pressure Switch

The air pressure switch is used to prove airflow from the fan for safe operation of the burner. It is adjustable and should be set once the dryer is full of grain.



Control Power Transformer

The Control Power Transformer transforms a portion of the incoming electrical power to reliable 120V control power, used to supply power to various electrical components.



Variable Frequency Drive

The Variable Frequency Drive is used to control the speed of the discharge metering system and is controlled directly by the PLC.

Low Voltage Cabinet

The Low Voltage Cabinet contains the PLC, I/O modules, breakers, relays and a safety relay module.

The 10' Tower Low Voltage Cabinet has two main variations which include an AccuDry and Non-AccuDry option:

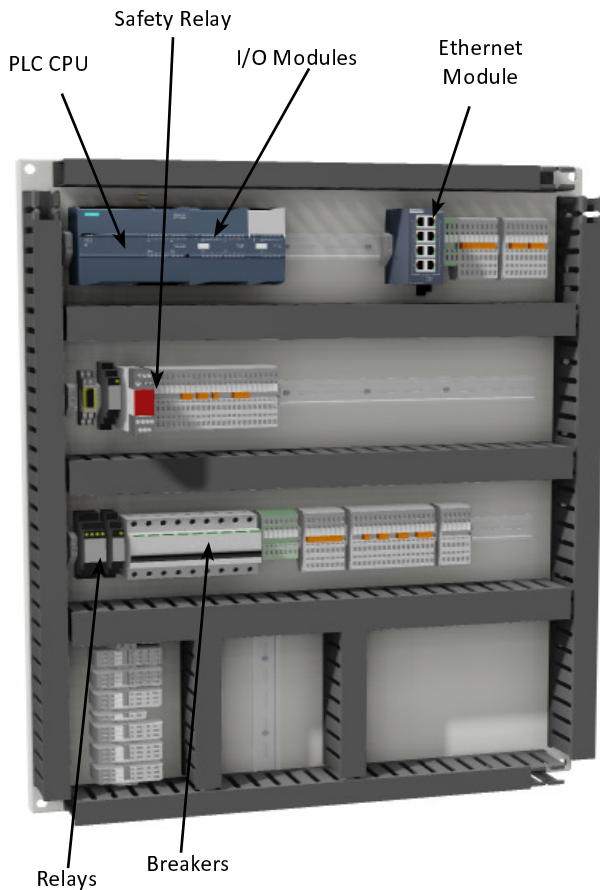

Without AccuDry

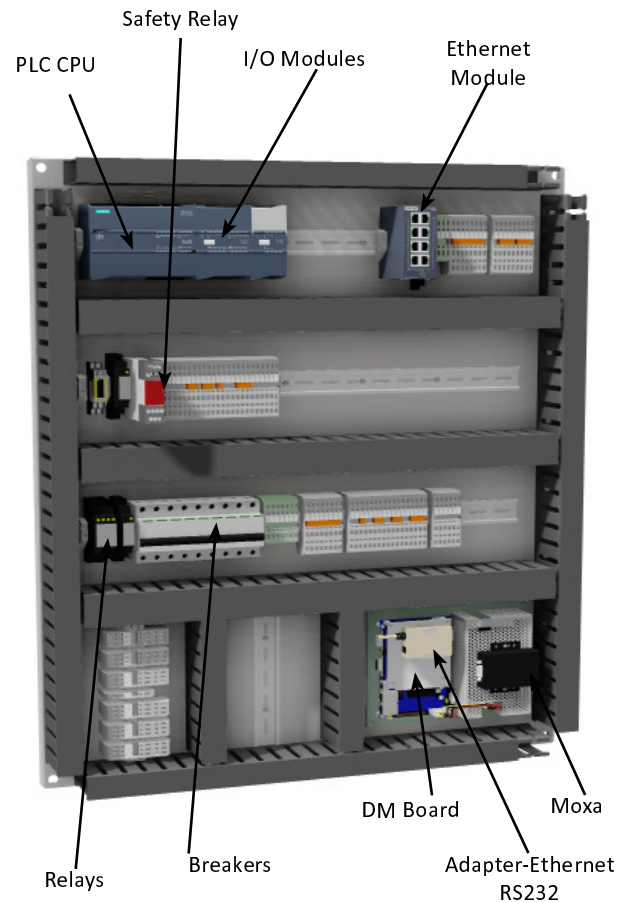

With AccuDry



Pinnacle 20|20 Remote Cabinet

The Pinnacle 20|20 Remote Cabinet and associated sub-panel, shown below, is where the Pinnacle 20|20 HMI touch screens are located, as well as the M-C Trax modem.



Human Machine Interface (HMI) Touch Screen

The HMI Touch Screens are where all Pinnacle 20|20 controls and related information is displayed. See the Pinnacle 20|20 Controls Manual for more information.

M-C Trax Modem

The M-C Trax Modem is a uniquely programmed modem that allows the dryer performance to be viewed remotely. This modem is located mounted to the back of one of the HMI's.

Pinnacle 20|20 Customer Equipment Cabinet

The Pinnacle 20|20 Customer Equipment Cabinet and associated sub-panel, shown below, is provided as the designated junction for wiring in customer equipment that is to be used in conjunction with the dryer operation.



Terminal Blocks

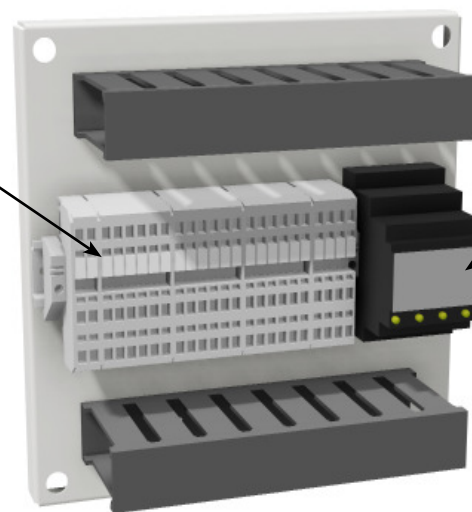

Relays



It is extremely important not to wire any customer equipment directly into any of the dryer cabinets except for the Customer Equipment Cabinet. The Customer Equipment Cabinet is the sole, designated place to wire in customer equipment. Failure to follow this may cause damage to other dryer components and will void the warranty.



Ignition Cabinet

The Ignition Cabinet houses the ignition board (10' tower) or the ignition transformer (12' and 18' tower) and the high limit switch.

10' Tower Ignition Cabinet

The 10' Tower Ignition Cabinet houses the ignition board and the high limit switch.



Ignition Board

The Ignition Board is a 120 Volt board and controls the overall operation of the burner by supplying high voltage from the coil to the spark plug to ignite the burner, sending signals to open/close the gas valves, and continuously monitoring the presence of a flame for safe and reliable operation.

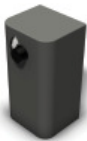

High Limit Switch

The High Limit Switch utilizes a capillary bulb to sense an over-temperature condition in the plenum which will cause the dryer to shutdown. The high limit setpoint is adjustable on the switch and should be set approximately 40 deg F higher than the plenum temperature setpoint.

12' /18' Tower Ignition Cabinet

The 12' / 18' Tower Ignition Cabinet houses the ignition transformer and the high limit switch.

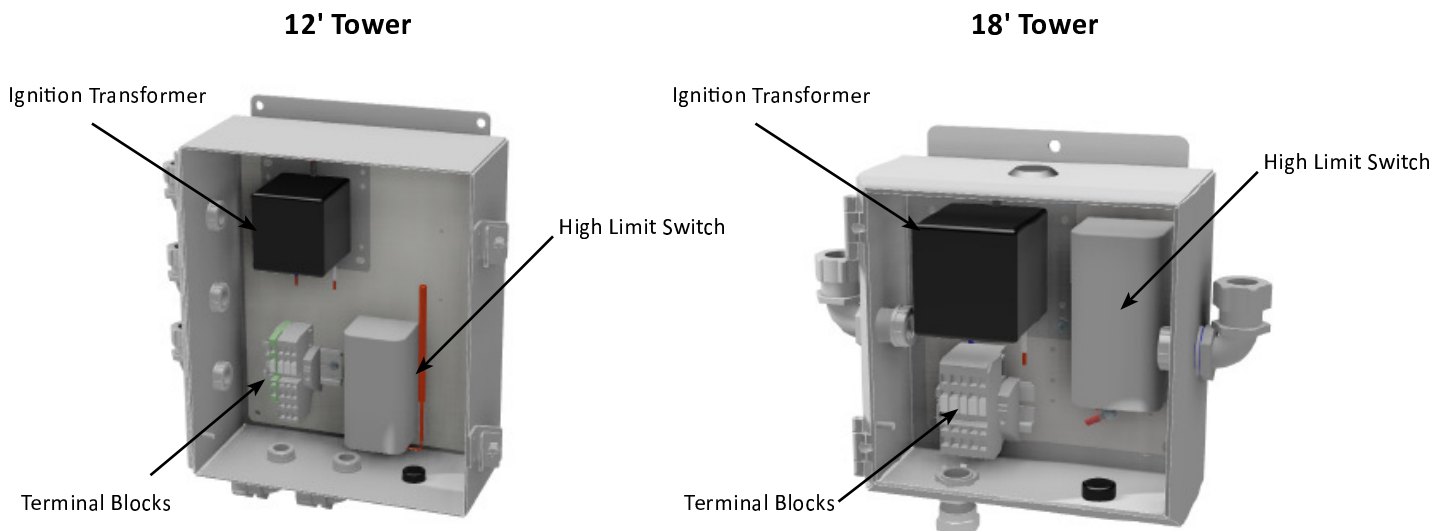

Ignition Transformer

The Ignition Transformer supplies the high voltage to the spark plug to ignite the burner.

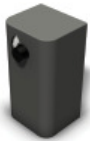

High Limit Switch

The High Limit Switch utilizes a capillary bulb to sense an over-temperature condition in the plenum which will cause the dryer to shutdown. The high limit setpoint is adjustable on the switch and should be set approximately 40 deg F higher than the plenum temperature setpoint.



Discharge Moisture Sampler (Optional)

The discharge moisture sampler is used to continuously collect a sample of grain, move it past the discharge moisture sensor in a controlled and steady fashion, and return the sampled grain back to the discharge of the dryer.

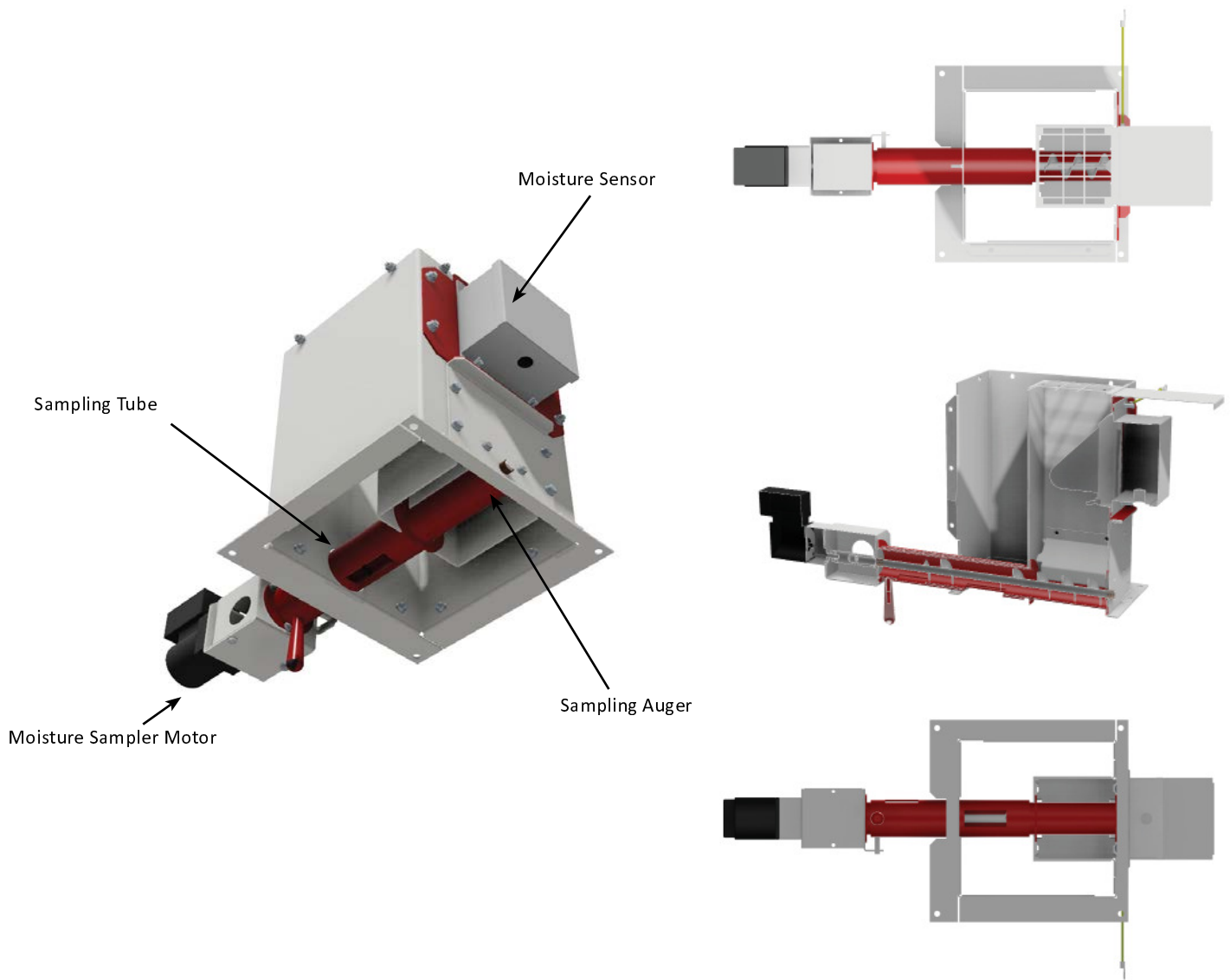

Moisture Sensor



The moisture sensor is an electronic device that measures the grain moisture indirectly by measuring the capacitance of the field of grain and correlating it to a voltage. Additionally, there is a small thermistor, which also produces an analog output voltage, mounted on the face of the sensor to measure the grain's temperature to compensate the moisture reading and to provide a real-time indication of the grain's temperatures. These voltages are measured by the PLC and when calibrated, will display the discharge grain moisture as well as the temperature on the HMI touchscreens.



Moisture Sampler Auger Motor

The Moisture Sampler Motor is a small fractional HP motor that slowly meters a sample of grain past the moisture sensor and returns the sampled grain back to the discharge of the dryer.



Gas Train

The purpose of the gas train is to safely and efficiently supply fuel at the correct pressure and flow rate to the burner. There are different variations of the gas train depending on what model and options are equipped on the machine.

If the dryer is equipped for LPG fuel, there will be liquid lines sending LPG to the vaporizer and back to the manifold (10' and 12' tower only). CE equipped machines will have gas pressure switches to meet local codes. CSA equipped machines will have valve proving shut-off valves as well as liquid and vapor venting to meet local codes.

10' Tower LPG Gas Train

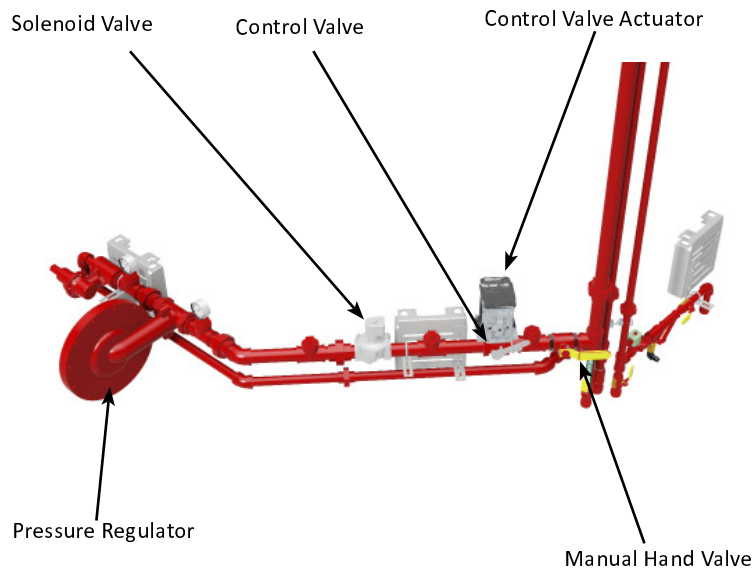

10' Tower LPG Gas Train (with Optional CSA Requirements)

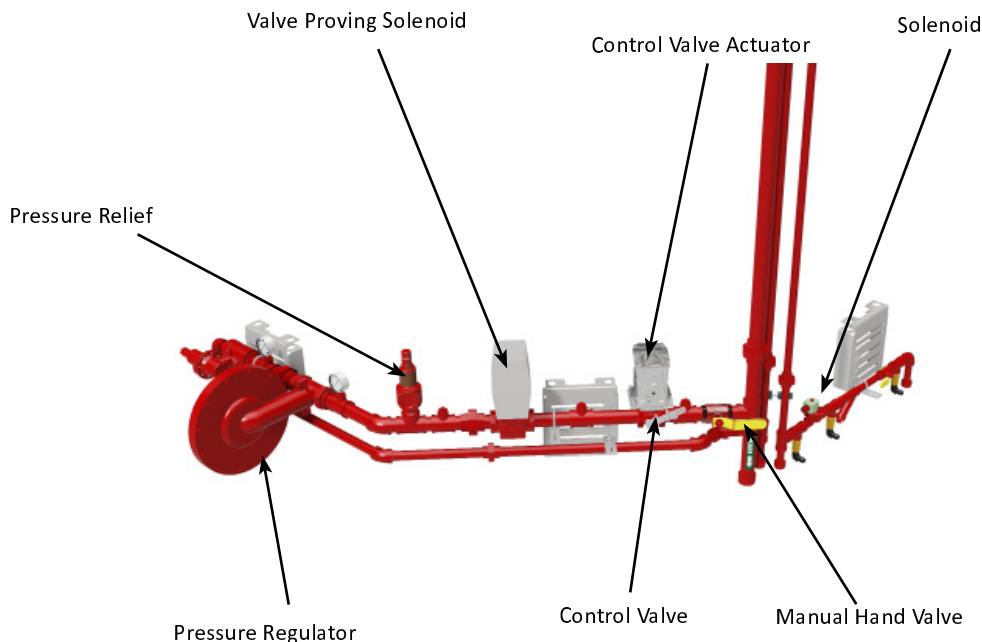

10' Tower NG Gas Train

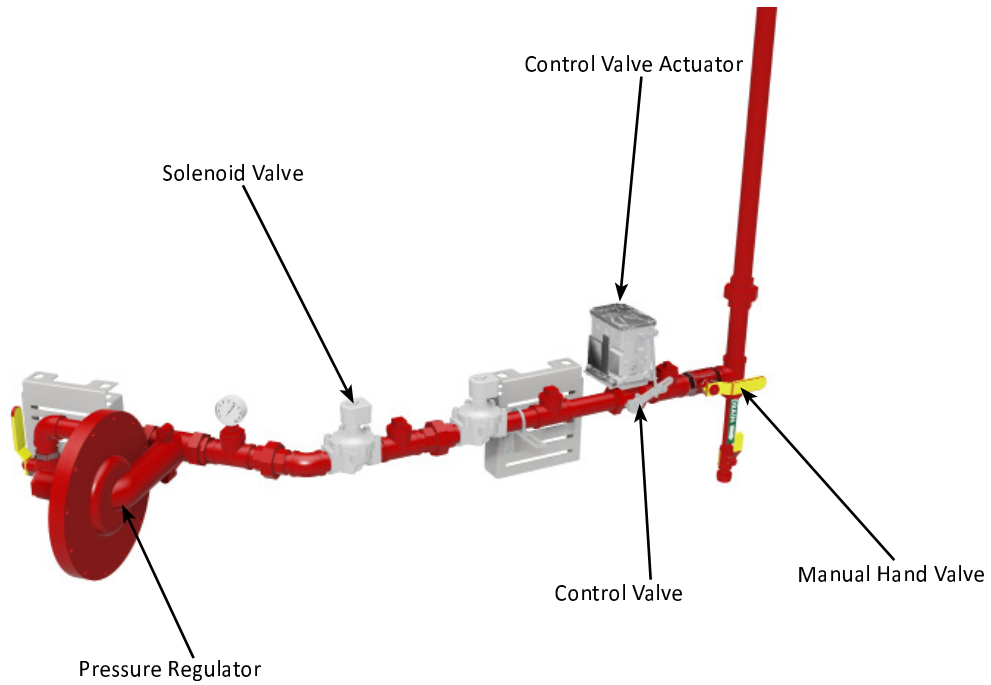

10' Tower NG Gas Train (With Optional CSA Requirements)

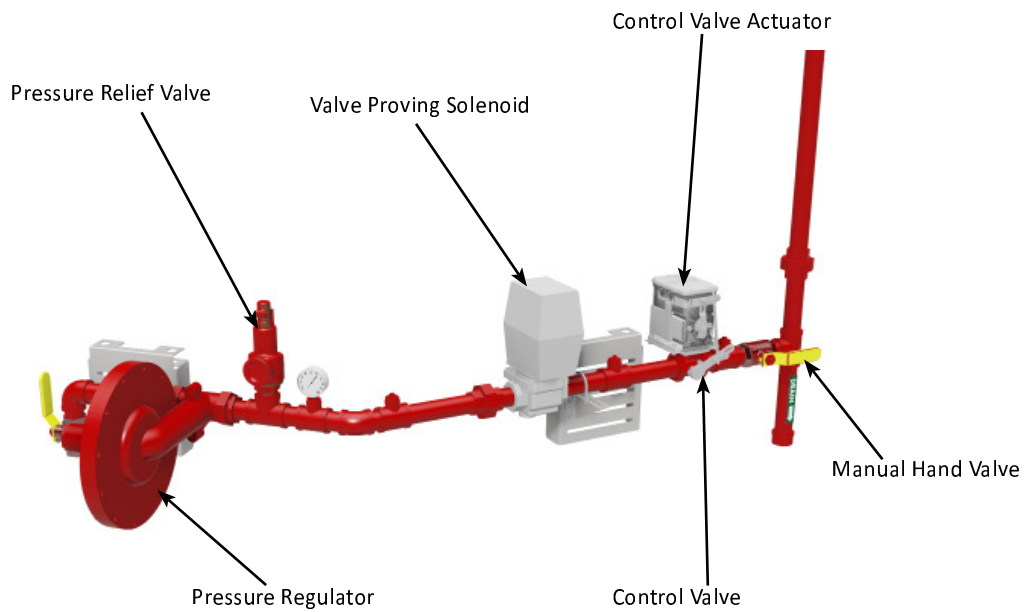

12' Tower LPG Gas Train

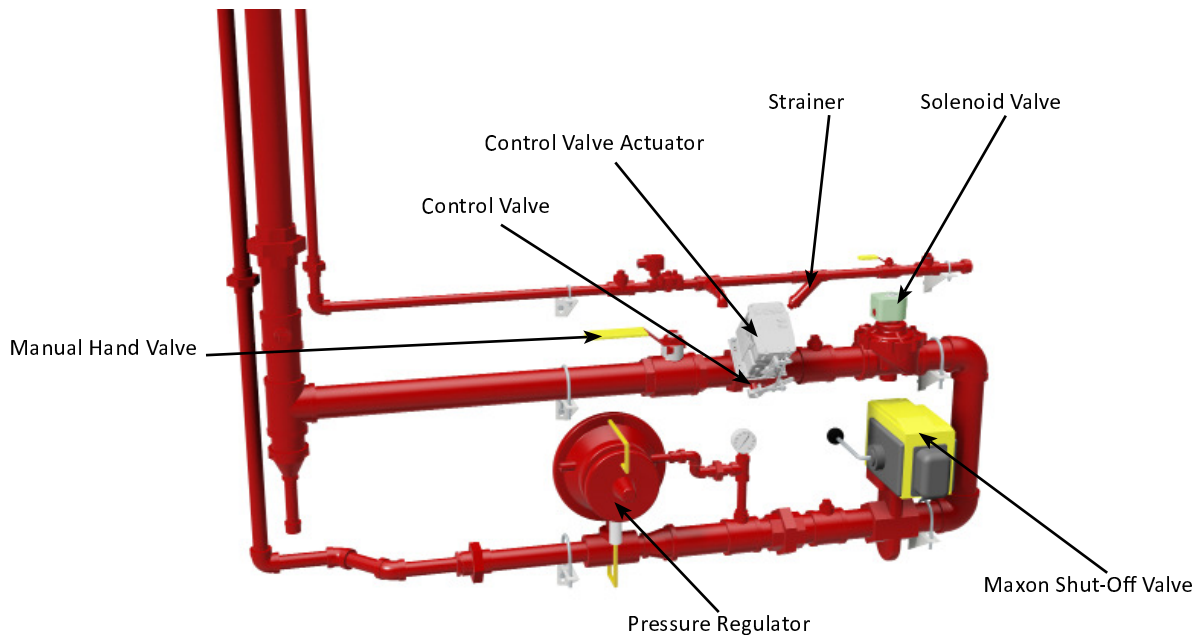

12' Tower LPG Gas Train (With Optional CSA Requirements)

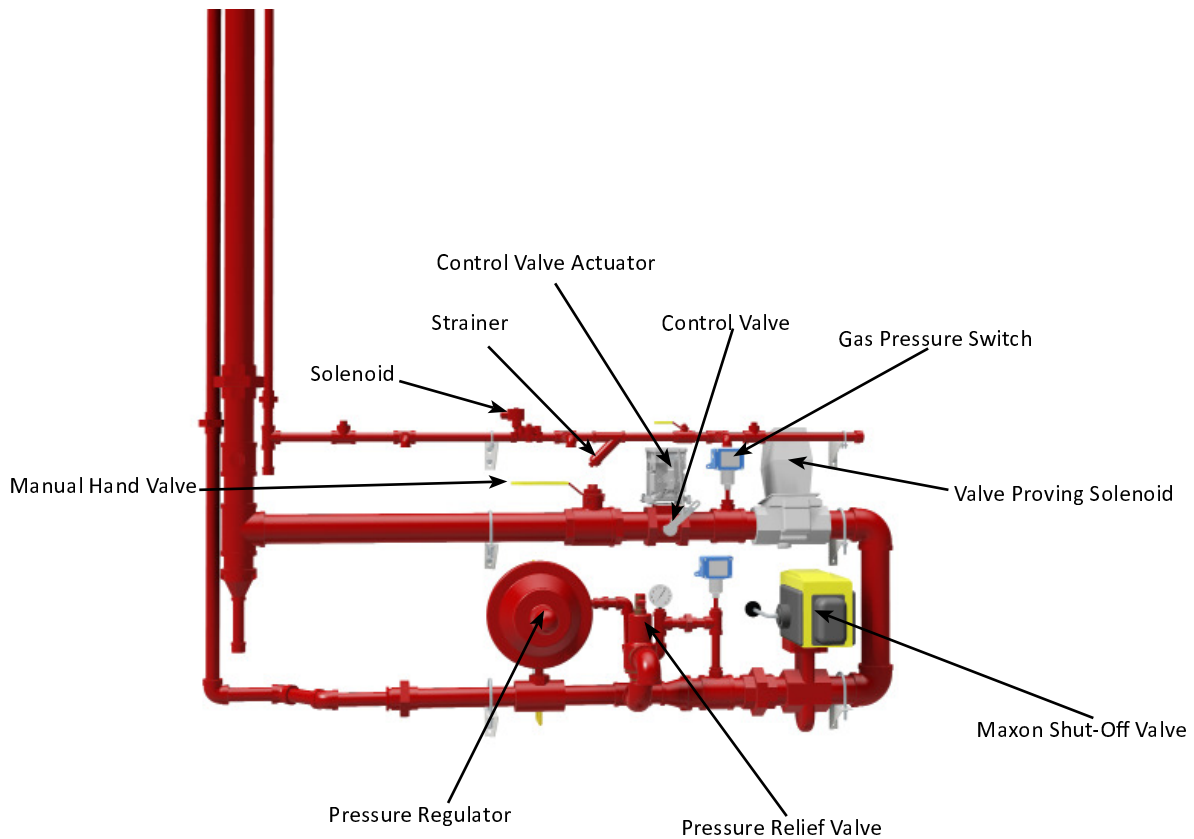

12' Tower NG Gas Train

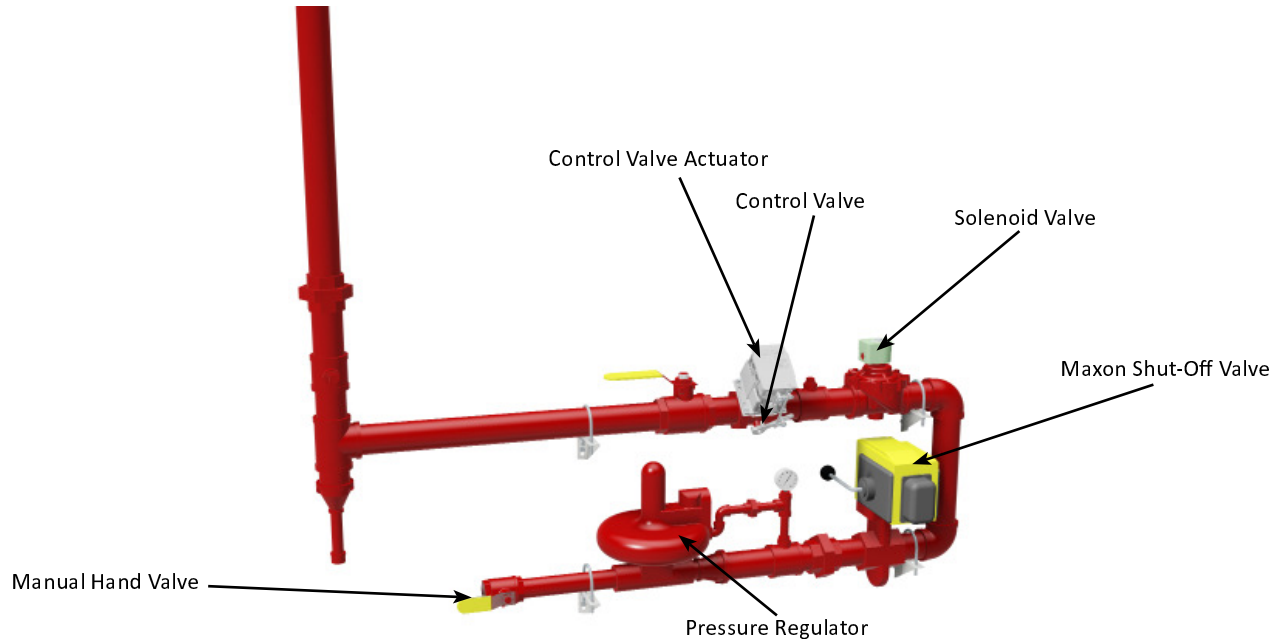

12' Tower NG Gas Train (With Optional CSA Requirements)

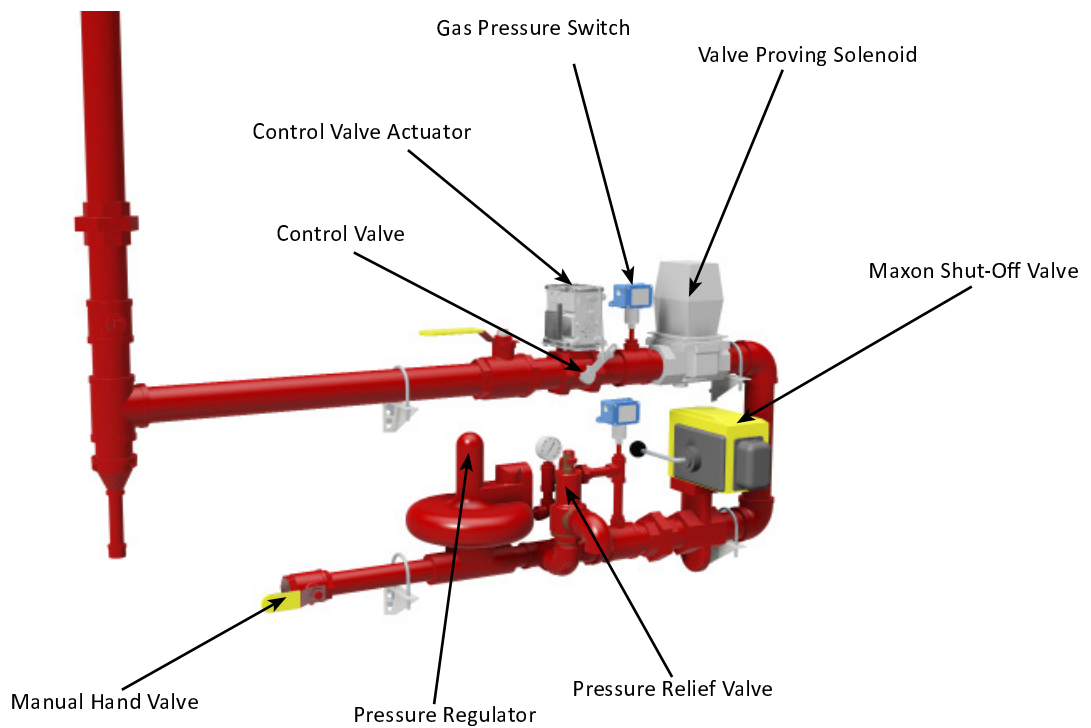

18' Tower Gas Train

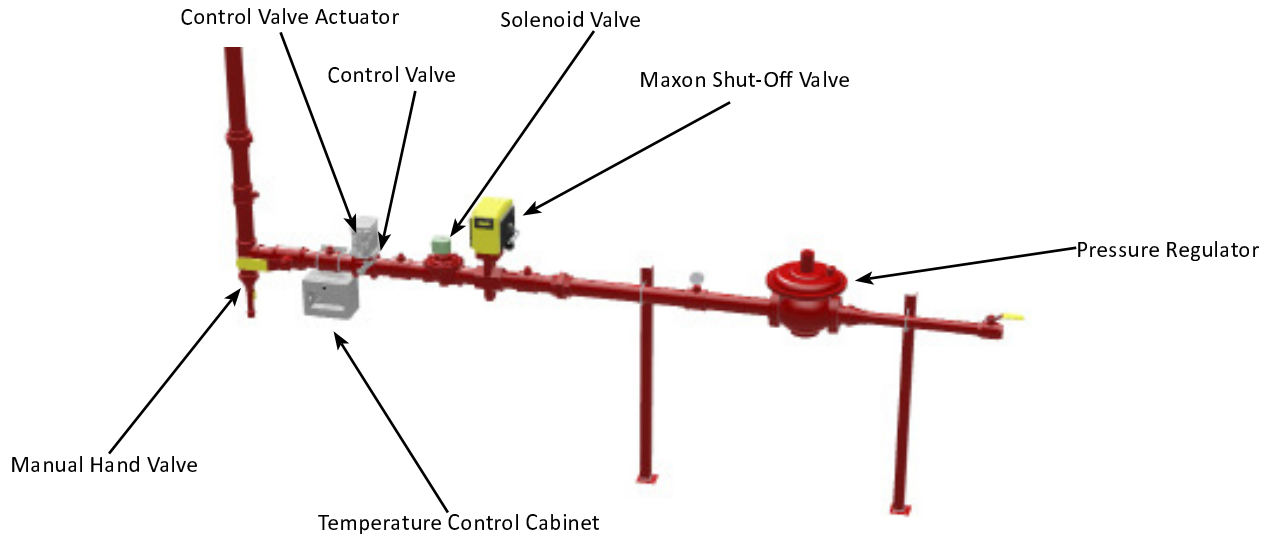



Control Valve

The Control Valve is a throttling butterfly valve that controls the fuel flow rate to the burner which is precisely positioned by the control valve actuator. The control valve is connected to the control valve actuator through a mechanical linkage.



Control Valve Actuator

The Control Valve Actuator is an electrical actuator that is connected to the control valve through a mechanical linkage that precisely positions itself based on the output of the PLC. As the plenum temperature drops below the setpoint, the PLC commands the control valve actuator to open more, whereas if the plenum temperature rises above the setpoint, the PLC commands the control valve actuator to close more.



Strainer

The purpose of the Strainer is to collect any foreign material with a wire mesh filter that may find its way into the fuel supply line.



Solenoid Valve

The Solenoid Valve is to start and stop the flow of fuel to the burner. The opening/closing actuation of the solenoid valve is monitored and performed by the ignition board.



Maxon Shutoff Valve

The Maxon Shutoff Valve provides locked shutoff service for the gas train (12' / 18' tower dryers only).



Pressure Relief Valve

The purpose of the Pressure Relief Valve is to automatically open and relieve excess pressure when the line pressure becomes too high. Once the pressure drops, the valve will close and seal again for continued proper operation.



Low / High Gas Pressure Switches

The Low / High Gas Pressure Switches are adjustable switches used to detect either low gas or high gas pressure in the gas train and shutdown the dryer.



Pressure Regulator

The Primary purpose of a Pressure Regulator is to continuously control the supply pressure of the fuel to the gas train manifold. There are various sizes and configurations based on model and equipped options, however the primary purpose is the same.



Manual Hand Valve

The purpose of a Manual Hand Valve is to manually open and close various portions of the gas train for maintenance purposes.



Valve Proving Solenoid

The valve proving solenoid stops and starts the flow of fuel to the burner. The opening/closing activation of the solenoid valve is monitored and performed by the ignition board. This solenoid detects proof of valve closure.

Burner

The burner, which consists of a cast iron burner body drilled to discharge gaseous fuel between diverging stainless steel mixing plates, is a burner which efficiently combusts the fuel/air mixture thereby producing the required process heat to the drying air.

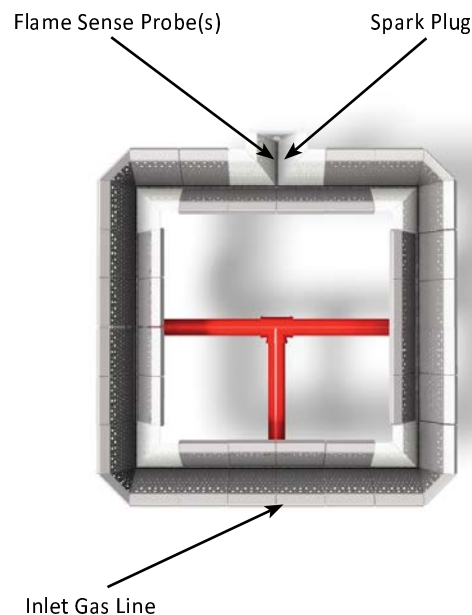

Spark Plug

The Spark Plug receives high voltage current from the ignition board and arcs at the spark plug gap to provide direct spark ignition for the burner.



Flame Sense Probe(s)**

The Flame Sense Probe detects the presence of the flame and provides positive confirmation to the ignition board so that operation of the burner may continue.

**** Note: 2x flame sense probes used for the 10' and 12' tower lines. The 18' tower line uses only a single flame sensing probe.**



Operating Procedures

Overview

This section will explain the operation of the primary components of the dryer as well as provide step-by-step procedures to properly start-up and shut-down the machine. Operational and functional descriptions along with adjustment details for primary components will be presented initially, followed by operational procedures for starting up and shutting down the dryer.

Component Adjustments

The following information will provide you with the details you need to properly operate the different components of the dryer and to make any adjustments necessary. The components listed in the pages following do not comprise everything that can be adjusted on the dryer, but rather the components that need to be adjusted based on normal operation.

Air Pressure Switch

The purpose of the Air Pressure Switch is to prove airflow from the fan for safe operation of the burner. Once the pressure switch has been satisfied, operation of the burner and its ignition system are permitted. In the event that air pressure is lost as indicated by a non-illuminated air pressure light, the burner will extinguish.

The air pressure switch is adjustable and should be set once the dryer is full of grain. Adjustment of the switch is done in the High Voltage Cabinet and indication of reaching the air pressure switch's setpoint is indicated by the green air pressure light on the outside of the cabinet.



Air Pressure Switch



The safety features associated with the air pressure switch(es) are for your safety and for the protection of the dryer. They should be checked for correct operation at the start of the drying season and periodically during the season as they are designed to protect the dryer from a fire that may result from fan (air flow) failure while the burner is ignited and a flame is present.



Setpoint Check

The following procedure shall be utilized to properly check the air pressure switch(es) setpoint. Note that the air pressure switch for each fan/burner must be checked and set independently.

1. After the dryer has been filled with grain and before the burner is ignited, the operation of each air pressure switch must be checked.
2. All of the fans must be running (including the cooling fans) before the air pressure switches can be accurately adjusted.
3. Start all fans and determine if the air pressure switch lamp illuminates once the respective fan has reached its normal operating speed.
4. If the indicator light does not illuminate or comes on too soon (before the fan reaches operating speed), the air pressure switch must be adjusted.

Switch Adjustment

In the event that the indicator light does not illuminate or comes on too soon (before the fan reaches operating speed), the following procedure shall be used to properly set the air pressure switch:

1. Remove the cap on the air pressure switch. Inside the air pressure switch use the slotted screw to make adjustments by turning clockwise or counter-clockwise.
2. Turn the adjusting screw counter-clockwise until the air pressure light comes on. After the air pressure light comes on, turn the adjusting screw counter-clockwise an additional $\frac{1}{4}$ to $\frac{1}{2}$ turn to allow for normal changes in static pressure.

If all air pressure switch adjustment is used and the air pressure light does not illuminate, the air pressure switch is defective and must be replaced. Once the switch is replaced, check its operation and make adjustments as previously outlined.

High Limit Switch

The purpose of the High Limit Switch is to provide a safety shutdown in the event that the temperature in any of the plenums has exceeded the high limit setpoint. The high limit switch senses the temperature in the plenum that it is monitoring by means of a capillary bulb temperature sensing device.

The high limit switch is adjustable and should be set once at the start of a drying season or for a given grain. Adjustment of the switch is done in the ignition box

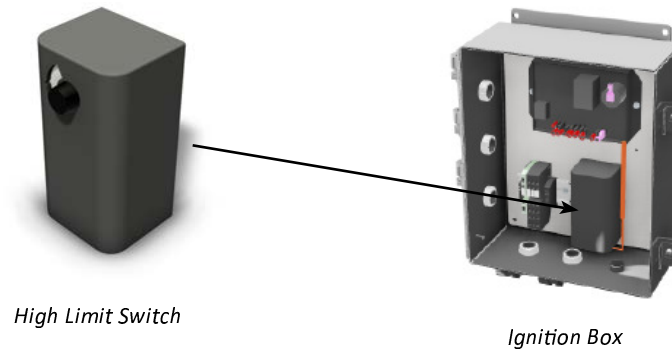

The safety features associated with the high limit switch(es) are for your safety and for the protection of the dryer. They should be checked for correct operation at the start of the drying season and periodically during the season as they are designed to protect the dryer from a fire that may result from fan (air flow) failure while the burner is ignited and a flame is present.

Setpoint Check and Switch Adjustment

The following procedure shall be utilized to properly check the high limit switch setpoint. Note that the high limit switch for each fan/burner must be checked and set independently. Once the high limit setpoint has been reached, the switch will need to be reset by pressing the small reset button on the top of the device.

After the dryer has been filled with grain and after the burner is ignited, the operation of each high limit switch must be checked.

1. Start the fan, ignite the burner and establish a stable temperature in the plenum.
2. Inside the burner control cabinet, adjust the high limit switch setpoint by turning the small dial counter-clockwise to a temperature below the current temperature in the plenum.
3. Once the high limit switch determines that the temperature in the plenum has exceeded the high limit setpoint, the switch will cause the dryer to shutdown and turn off the respective plenum's high limit light on the remote cabinet.
4. If the high limit switch does not shut down the dryer, it is defective and must be replaced. Once the switch is replaced, check its operation and make adjustments as previously outlined.
5. If the setpoint is exceeded and properly shuts down the dryer, the setpoint can be adjusted to a value that is approximately 40 deg F above the desired plenum temperature.



Variable Frequency Drive (VFD)

The purpose of the variable frequency drive is to control the speed of the discharge sweep system. The table below is the M-C settings that comes standard from the factory.

Variable Frequency Drive Parameters For 10' Tower, 208V/3-Phase

| Parameter Number | Description | M-C Setting | Factory Default |
|--|-----------------------|---------------|-----------------|
| Group 99 Start Up Data | | | |
| 9901 | Language | English | English |
| 9902 | Applied Macro | ABB Standard | None |
| 9904 | Motor Control Mode | Scalar - Freq | Scalar - Freq |
| 9905 | Motor Nominal Voltage | 208 | NA |
| 9906 | Motor Nominal Current | 14 | NA |
| 9907 | Motor Nominal Freq | 60 | 60.0 |
| 9908 | Motor Nominal Speed | 1725 | 1710 |
| 9909 | Motor Nominal Power | 5Hp | 3Hp |
| Group 10 Start / Stop / Direction | | | |
| 1001 | Ext 1 Command | DI1 | DI1,2 |
| 1003 | Direction | Forward | Request |
| Group 11 Reference Select | | | |
| 1104 | Reference 1 Minimum | 0Hz | 0Hz |
| 1105 | Reference 1 Maximum | 60Hz | 60Hz |
| Group 12 Constant Speeds | | | |
| 1201 | Constant Speed Select | DI4,5 | DI3,4 |
| Group 14 Relay Outputs | | | |
| 1407 | RO 2 Off Delay | 30 Sec | 0 Sec |
| Group 15 Analogue Outputs | | | |
| 1501 | A01 Content Select | Ext Ref 1 | Output Freq |
| Group 16 System Controls | | | |
| 1601 | Run Enable | DI3 | NOT SEL |
| Group 20 Limits | | | |
| 2003 | Max Current | 17.0 | 8.5 |
| 2007 | Minimum Freq | 0Hz | 0.0Hz |
| 2008 | Maximum Freq | 60Hz | 60.0Hz |
| Group 34 Panel Display | | | |
| 3415 | Signal 3 Parameters | DI1-3 Status | Torque |

Variable Frequency Drive Parameters For 10' Tower, 230V/3-Phase

| Parameter Number | Description | M-C Setting | Factory Default |
|--|-----------------------|---------------|-----------------|
| Group 99 Start Up Data | | | |
| 9901 | Language | English | English |
| 9902 | Applied Macro | ABB Standard | None |
| 9904 | Motor Control Mode | Scalar - Freq | Scalar - Freq |
| 9905 | Motor Nominal Voltage | 230 | NA |
| 9906 | Motor Nominal Current | 12.7 | NA |
| 9907 | Motor Nominal Freq | 60 | 60.0 |
| 9908 | Motor Nominal Speed | 1725 | 1710 |
| 9909 | Motor Nominal Power | 5Hp | 3Hp |
| Group 10 Start / Stop / Direction | | | |
| 1001 | Ext 1 Command | DI1 | DI1,2 |
| 1003 | Direction | Forward | Request |
| Group 11 Reference Select | | | |
| 1104 | Reference 1 Minimum | 0Hz | 0Hz |
| 1105 | Reference 1 Maximum | 60Hz | 60Hz |
| Group 12 Constant Speeds | | | |
| 1201 | Constant Speed Select | DI4,5 | DI3,4 |
| Group 14 Relay Outputs | | | |
| 1407 | RO 2 Off Delay | 30 Sec | 0 Sec |
| Group 15 Analogue Outputs | | | |
| 1501 | A01 Content Select | Ext Ref 1 | Output Freq |
| Group 16 System Controls | | | |
| 1601 | Run Enable | DI3 | NOT SEL |
| Group 20 Limits | | | |
| 2003 | Max Current | 13.5 | 8.5 |
| 2007 | Minimum Freq | 0Hz | 0.0Hz |
| 2008 | Maximum Freq | 60Hz | 60.0Hz |
| Group 34 Panel Display | | | |
| 3415 | Signal 3 Parameters | DI1-3 Status | Torque |



Variable Frequency Drive Parameters For 10' Tower, 380V/3-Phase

| Parameter Number | Description | M-C Setting | Factory Default |
|--|-----------------------|---------------|-----------------|
| Group 99 Start Up Data | | | |
| 9901 | Language | English | English |
| 9902 | Applied Macro | ABB Standard | None |
| 9904 | Motor Control Mode | Scalar - Freq | Scalar - Freq |
| 9905 | Motor Nominal Voltage | 380 | NA |
| 9906 | Motor Nominal Current | 8 | NA |
| 9907 | Motor Nominal Freq | 50 | 60.0 |
| 9908 | Motor Nominal Speed | 1435 | 1710 |
| 9909 | Motor Nominal Power | 5Hp | 3Hp |
| Group 10 Start / Stop / Direction | | | |
| 1001 | Ext 1 Command | DI1 | DI1,2 |
| 1003 | Direction | Forward | Request |
| Group 11 Reference Select | | | |
| 1104 | Reference 1 Minimum | 0Hz | 0Hz |
| 1105 | Reference 1 Maximum | 60Hz | 60Hz |
| Group 12 Constant Speeds | | | |
| 1201 | Constant Speed Select | DI4,5 | DI3,4 |
| Group 14 Relay Outputs | | | |
| 1407 | RO 2 Off Delay | 30 Sec | 0 Sec |
| Group 15 Analogue Outputs | | | |
| 1501 | A01 Content Select | Ext Ref 1 | Output Freq |
| Group 16 System Controls | | | |
| 1601 | Run Enable | DI3 | NOT SEL |
| Group 20 Limits | | | |
| 2003 | Max Current | 9.2 | 8.5 |
| 2007 | Minimum Freq | 0Hz | 0.0Hz |
| 2008 | Maximum Freq | 60Hz | 60.0Hz |
| Group 34 Panel Display | | | |
| 3415 | Signal 3 Parameters | DI1-3 Status | Torque |

Variable Frequency Drive Parameters For 10' Tower, 460V/3-Phase

| Parameter Number | Description | M-C Setting | Factory Default |
|--|-----------------------|---------------|-----------------|
| Group 99 Start Up Data | | | |
| 9901 | Language | English | English |
| 9902 | Applied Macro | ABB Standard | None |
| 9904 | Motor Control Mode | Scalar - Freq | Scalar - Freq |
| 9905 | Motor Nominal Voltage | 460 | NA |
| 9906 | Motor Nominal Current | 6.35 | NA |
| 9907 | Motor Nominal Freq | 60 | 60.0 |
| 9908 | Motor Nominal Speed | 1725 | 1710 |
| 9909 | Motor Nominal Power | 5Hp | 3Hp |
| Group 10 Start / Stop / Direction | | | |
| 1001 | Ext 1 Command | DI1 | DI1,2 |
| 1003 | Direction | Forward | Request |
| Group 11 Reference Select | | | |
| 1104 | Reference 1 Minimum | 0Hz | 0Hz |
| 1105 | Reference 1 Maximum | 60Hz | 60Hz |
| Group 12 Constant Speeds | | | |
| 1201 | Constant Speed Select | DI4,5 | DI3,4 |
| Group 14 Relay Outputs | | | |
| 1407 | RO 2 Off Delay | 30 Sec | 0 Sec |
| Group 15 Analogue Outputs | | | |
| 1501 | A01 Content Select | Ext Ref 1 | Output Freq |
| Group 16 System Controls | | | |
| 1601 | Run Enable | DI3 | NOT SEL |
| Group 20 Limits | | | |
| 2003 | Max Current | 7.8 | 8.5 |
| 2007 | Minimum Freq | 0Hz | 0.0Hz |
| 2008 | Maximum Freq | 60Hz | 60.0Hz |
| Group 34 Panel Display | | | |
| 3415 | Signal 3 Parameters | DI1-3 Status | Torque |



Variable Frequency Drive Parameters For 10' Tower, 575V/3-Phase

| Parameter Number | Description | M-C Setting | Factory Default |
|---------------------------------|-----------------------|----------------|-----------------|
| 9902 | Applied Macro | ABB Standard | None |
| 9904 | Control Mode | Vector - Speed | Scalar - Freq |
| 9905 | Nominal Voltage | 575 V | NA |
| 9906 | Nominal Current | 5.2 | NA |
| 9907 | Nominal Freq | 60 Hz | 60 Hz |
| 9908 | Nominal Speed | 1755 rpm | 1710 rpm |
| 9909 | Nominal Power | 5Hp | 3Hp |
| Start / Stop / Direction | | | |
| 1001 | Ext 1 Command | DI1 | DI1,2 |
| 1003 | Direction | Forward | Request |
| 1104 | Ref. 1 MIN | 0 rpm | 0 Hz |
| 1105 | Ref. 1 MAX | 1760 rpm | 60 Hz |
| Constant Speeds | | | |
| 1201 | Constant Speed Select | DI4,5 | DI3,4 |
| Relay Outputs | | | |
| 1407 | RO 2 Off Delay | 30 Sec | 0 Sec |
| Analogue Outputs | | | |
| 1501 | A01 Content Select | Ext Ref 1 | Output Freq |
| System Controls | | | |
| 1601 | Run Enable | DI3 | Not Selected |
| Limits | | | |
| 2003 | Max Current | 6.5 A | 8.5 A |
| 2007 | MIN Freq | 0rpm | 0 Hz |
| 2008 | MAX Freq | 1755 rpm | 60 Hz |
| Panel Display | | | |
| 3415 | Signal 3 Parameters | DI1-3 Status | Torque |

Variable Frequency Drive Parameters For 10' Tower, 230V/1-Phase

| Parameter Number | Description | M-C Setting | Factory Default |
|--|-----------------------|---------------|-----------------|
| Group 99 Start Up Data | | | |
| 9901 | Language | English | English |
| 9902 | Applied Macro | ABB Standard | None |
| 9904 | Motor Control Mode | Scalar - Freq | Scalar - Freq |
| 9905 | Motor Nominal Voltage | 230 | NA |
| 9906 | Motor Nominal Current | 12.7 | NA |
| 9907 | Motor Nominal Freq | 60 | 60.0 |
| 9908 | Motor Nominal Speed | 1725 | 1710 |
| 9909 | Motor Nominal Power | 5Hp | 3Hp |
| Group 10 Start / Stop / Direction | | | |
| 1001 | Ext 1 Command | DI1 | DI1,2 |
| 1003 | Direction | Forward | Request |
| Group 11 Reference Select | | | |
| 1104 | Reference 1 Minimum | 0Hz | 0Hz |
| 1105 | Reference 1 Maximum | 60Hz | 60Hz |
| Group 12 Constant Speeds | | | |
| 1201 | Constant Speed Select | DI4,5 | DI3,4 |
| Group 14 Relay Outputs | | | |
| 1407 | RO 2 Off Delay | 30 Sec | 0 Sec |
| Group 15 Analogue Outputs | | | |
| 1501 | A01 Content Select | Ext Ref 1 | Output Freq |
| Group 16 System Controls | | | |
| 1601 | Run Enable | DI3 | NOT SEL |
| Group 20 Limits | | | |
| 2003 | Max Current | 13.5 | 8.5 |
| 2007 | Minimum Freq | 0Hz | 0.0Hz |
| 2008 | Maximum Freq | 60Hz | 60.0Hz |
| Group 34 Panel Display | | | |
| 3415 | Signal 3 Parameters | DI1-3 Status | Torque |



Variable Frequency Drive Parameters For 10' Tower, 460V/1-Phase

| Parameter Number | Description | M-C Setting | Factory Default |
|--|-----------------------|---------------|-----------------|
| Group 99 Start Up Data | | | |
| 9901 | Language | English | English |
| 9902 | Applied Macro | ABB Standard | None |
| 9904 | Motor Control Mode | Scalar - Freq | Scalar - Freq |
| 9905 | Motor Nominal Voltage | 460 | NA |
| 9906 | Motor Nominal Current | 6.35 | NA |
| 9907 | Motor Nominal Freq | 60 | 60.0 |
| 9908 | Motor Nominal Speed | 1725 | 1710 |
| 9909 | Motor Nominal Power | 5Hp | 3Hp |
| Group 10 Start / Stop / Direction | | | |
| 1001 | Ext 1 Command | DI1 | DI1,2 |
| 1003 | Direction | Forward | Request |
| Group 11 Reference Select | | | |
| 1104 | Reference 1 Minimum | 0Hz | 0Hz |
| 1105 | Reference 1 Maximum | 60Hz | 60Hz |
| Group 12 Constant Speeds | | | |
| 1201 | Constant Speed Select | DI4,5 | DI3,4 |
| Group 14 Relay Outputs | | | |
| 1407 | RO 2 Off Delay | 30 Sec | 0 Sec |
| Group 15 Analogue Outputs | | | |
| 1501 | A01 Content Select | Ext Ref 1 | Output Freq |
| Group 16 System Controls | | | |
| 1601 | Run Enable | DI3 | NOT SEL |
| Group 20 Limits | | | |
| 2003 | Max Current | 7.8 | 8.5 |
| 2007 | Minimum Freq | 0Hz | 0.0Hz |
| 2008 | Maximum Freq | 60Hz | 60.0Hz |
| Group 34 Panel Display | | | |
| 3415 | Signal 3 Parameters | DI1-3 Status | Torque |

Variable Frequency Drive Parameters For 12' Tower, 208V/3-Phase

| Parameter Number | Description | M-C Setting | Factory Default |
|--|-----------------------|---------------|-----------------|
| Group 99 Start Up Data | | | |
| 9901 | Language | English | English |
| 9902 | Applied Macro | ABB Standard | None |
| 9904 | Motor Control Mode | Scalar - Freq | Scalar - Freq |
| 9905 | Motor Nominal Voltage | 208 | NA |
| 9906 | Motor Nominal Current | 14 | NA |
| 9907 | Motor Nominal Freq | 60 | 60.0 |
| 9908 | Motor Nominal Speed | 1725 | 1710 |
| 9909 | Motor Nominal Power | 5Hp | 3Hp |
| Group 10 Start / Stop / Direction | | | |
| 1001 | Ext 1 Command | DI1 | DI1,2 |
| 1003 | Direction | Forward | Request |
| Group 11 Reference Select | | | |
| 1104 | Reference 1 Minimum | 0Hz | 0Hz |
| 1105 | Reference 1 Maximum | 60Hz | 60Hz |
| Group 12 Constant Speeds | | | |
| 1201 | Constant Speed Select | DI4,5 | DI3,4 |
| Group 14 Relay Outputs | | | |
| 1407 | RO 2 Off Delay | 30 Sec | 0 Sec |
| Group 15 Analogue Outputs | | | |
| 1501 | A01 Content Select | Ext Ref 1 | Output Freq |
| Group 16 System Controls | | | |
| 1601 | Run Enable | DI3 | NOT SEL |
| Group 20 Limits | | | |
| 2003 | Max Current | 17.0 | 8.5 |
| 2007 | Minimum Freq | 0Hz | 0.0Hz |
| 2008 | Maximum Freq | 60Hz | 60.0Hz |
| Group 34 Panel Display | | | |
| 3415 | Signal 3 Parameters | DI1-3 Status | Torque |



Variable Frequency Drive Parameters For 12' Tower, 230V/3-Phase

| Parameter Number | Description | M-C Setting | Factory Default |
|--|-----------------------|---------------|-----------------|
| Group 99 Start Up Data | | | |
| 9901 | Language | English | English |
| 9902 | Applied Macro | ABB Standard | None |
| 9904 | Motor Control Mode | Scalar - Freq | Scalar - Freq |
| 9905 | Motor Nominal Voltage | 230 | NA |
| 9906 | Motor Nominal Current | 12.7 | NA |
| 9907 | Motor Nominal Freq | 60 | 60.0 |
| 9908 | Motor Nominal Speed | 1725 | 1710 |
| 9909 | Motor Nominal Power | 5Hp | 3Hp |
| Group 10 Start / Stop / Direction | | | |
| 1001 | Ext 1 Command | DI1 | DI1,2 |
| 1003 | Direction | Forward | Request |
| Group 11 Reference Select | | | |
| 1104 | Reference 1 Minimum | 0Hz | 0Hz |
| 1105 | Reference 1 Maximum | 60Hz | 60Hz |
| Group 12 Constant Speeds | | | |
| 1201 | Constant Speed Select | DI4,5 | DI3,4 |
| Group 14 Relay Outputs | | | |
| 1407 | RO 2 Off Delay | 30 Sec | 0 Sec |
| Group 15 Analogue Outputs | | | |
| 1501 | A01 Content Select | Ext Ref 1 | Output Freq |
| Group 16 System Controls | | | |
| 1601 | Run Enable | DI3 | NOT SEL |
| Group 20 Limits | | | |
| 2003 | Max Current | 13.5 | 8.5 |
| 2007 | Minimum Freq | 0Hz | 0.0Hz |
| 2008 | Maximum Freq | 60Hz | 60.0Hz |
| Group 34 Panel Display | | | |
| 3415 | Signal 3 Parameters | DI1-3 Status | Torque |

Variable Frequency Drive Parameters For 12' Tower, 460V/3-Phase

| Parameter Number | Description | M-C Setting | Factory Default |
|--|-----------------------|---------------|-----------------|
| Group 99 Start Up Data | | | |
| 9901 | Language | English | English |
| 9902 | Applied Macro | ABB Standard | None |
| 9904 | Motor Control Mode | Scalar - Freq | Scalar - Freq |
| 9905 | Motor Nominal Voltage | 460 | NA |
| 9906 | Motor Nominal Current | 6.35 | NA |
| 9907 | Motor Nominal Freq | 60 | 60.0 |
| 9908 | Motor Nominal Speed | 1725 | 1710 |
| 9909 | Motor Nominal Power | 5Hp | 3Hp |
| Group 10 Start / Stop / Direction | | | |
| 1001 | Ext 1 Command | DI1 | DI1,2 |
| 1003 | Direction | Forward | Request |
| Group 11 Reference Select | | | |
| 1104 | Reference 1 Minimum | 0Hz | 0Hz |
| 1105 | Reference 1 Maximum | 60Hz | 60Hz |
| Group 12 Constant Speeds | | | |
| 1201 | Constant Speed Select | DI4,5 | DI3,4 |
| Group 14 Relay Outputs | | | |
| 1407 | RO 2 Off Delay | 30 Sec | 0 Sec |
| Group 15 Analogue Outputs | | | |
| 1501 | A01 Content Select | Ext Ref 1 | Output Freq |
| Group 16 System Controls | | | |
| 1601 | Run Enable | DI3 | NOT SEL |
| Group 20 Limits | | | |
| 2003 | Max Current | 7.8 | 8.5 |
| 2007 | Minimum Freq | 0Hz | 0.0Hz |
| 2008 | Maximum Freq | 60Hz | 60.0Hz |
| Group 34 Panel Display | | | |
| 3415 | Signal 3 Parameters | DI1-3 Status | Torque |



Variable Frequency Drive Parameters For 12' Tower, 575V/3-Phase

| Parameter Number | Description | M-C Setting | Factory Default |
|--|-----------------------|----------------|-----------------|
| Group 99 Start Up Data | | | |
| 9901 | Language | English | English |
| 9902 | Applied Macro | ABB Standard | None |
| 9904 | Motor Control Mode | Vector - Speed | Scalar - Freq |
| 9905 | Motor Nominal Voltage | 575 | NA |
| 9906 | Motor Nominal Current | 5.2 | NA |
| 9907 | Motor Nominal Freq | 60 | 60.0 |
| 9908 | Motor Nominal Speed | 1745 | 1710 |
| 9909 | Motor Nominal Power | 5Hp | 3Hp |
| Group 10 Start / Stop / Direction | | | |
| 1001 | Ext 1 Command | DI1 | DI1,2 |
| 1003 | Direction | Forward | Request |
| Group 11 Reference Select | | | |
| 1104 | Reference 1 Minimum | 0 rpm | 0 rpm |
| 1105 | Reference 1 Maximum | 1800 rpm | 1800 rpm |
| Group 12 Constant Speeds | | | |
| 1201 | Constant Speed Select | DI4,5 | DI3,4 |
| Group 14 Relay Outputs | | | |
| 1407 | RO 2 Off Delay | 30 Sec | 0 Sec |
| Group 15 Analogue Outputs | | | |
| 1501 | A01 Content Select | Ext Ref 1 | Output Freq |
| Group 16 System Controls | | | |
| 1601 | Run Enable | DI3 | NOT SEL |
| Group 20 Limits | | | |
| 2001 | Minimum Speed | 0 rpm | 0 rpm |
| 2002 | Maximum Speed | 1800 rpm | 1800 rpm |
| 2003 | Max Current | 7.0 | 8.5 |
| 2007 | Minimum Freq | 5Hz | 0.0Hz |
| 2008 | Maximum Freq | 72Hz | 60.0Hz |
| Group 34 Panel Display | | | |
| 3415 | Signal 3 Parameters | DI1-3 Status | Torque |

Variable Frequency Drive Parameters For 18' Tower, 208V/3-Phase

| Parameter Number | Description | M-C Setting | Factory Default |
|--|-----------------------|---------------|-----------------|
| Group 99 Start Up Data | | | |
| 9901 | Language | English | English |
| 9902 | Applied Macro | ABB Standard | None |
| 9904 | Motor Control Mode | Scalar - Freq | Scalar - Freq |
| 9905 | Motor Nominal Voltage | 208 | NA |
| 9906 | Motor Nominal Current | 6.5 | NA |
| 9907 | Motor Nominal Freq | 60 | 60.0 |
| 9908 | Motor Nominal Speed | 1735 | 1710 |
| 9909 | Motor Nominal Power | 2Hp | 3Hp |
| Group 10 Start / Stop / Direction | | | |
| 1001 | Ext 1 Command | DI1 | DI1,2 |
| 1003 | Direction | Forward | Request |
| Group 11 Reference Select | | | |
| 1104 | Reference 1 Minimum | 0Hz | 0Hz |
| 1105 | Reference 1 Maximum | 60Hz | 60Hz |
| Group 12 Constant Speeds | | | |
| 1201 | Constant Speed Select | DI4,5 | DI3,4 |
| Group 14 Relay Outputs | | | |
| 1407 | RO 2 Off Delay | 30 Sec | 0 Sec |
| Group 15 Analogue Outputs | | | |
| 1501 | A01 Content Select | Ext Ref 1 | Output Freq |
| Group 16 System Controls | | | |
| 1601 | Run Enable | DI3 | NOT SEL |
| Group 20 Limits | | | |
| 2003 | Max Current | 8.5 | 8.5 |
| 2007 | Minimum Freq | 0Hz | 0.0Hz |
| 2008 | Maximum Freq | 60Hz | 60.0Hz |
| Group 34 Panel Display | | | |
| 3415 | Signal 3 Parameters | DI1-3 Status | Torque |



Variable Frequency Drive Parameters For 18' Tower, 230V/3-Phase















| Parameter Number | Description | M-C Setting | Factory Default |
|--|-----------------------|---------------|-----------------|
| Group 99 Start Up Data | | | |
| 9901 | Language | English | English |
| 9902 | Applied Macro | ABB Standard | None |
| 9904 | Motor Control Mode | Scalar - Freq | Scalar - Freq |
| 9905 | Motor Nominal Voltage | 230 | NA |
| 9906 | Motor Nominal Current | 6 | NA |
| 9907 | Motor Nominal Freq | 60 | 60.0 |
| 9908 | Motor Nominal Speed | 1735 | 1710 |
| 9909 | Motor Nominal Power | 2Hp | 3Hp |
| Group 10 Start / Stop / Direction | | | |
| 1001 | Ext 1 Command | DI1 | DI1,2 |
| 1003 | Direction | Forward | Request |
| Group 11 Reference Select | | | |
| 1104 | Reference 1 Minimum | 0Hz | 0Hz |
| 1105 | Reference 1 Maximum | 60Hz | 60Hz |
| Group 12 Constant Speeds | | | |
| 1201 | Constant Speed Select | DI4,5 | DI3,4 |
| Group 14 Relay Outputs | | | |
| 1407 | RO 2 Off Delay | 30 Sec | 0 Sec |
| Group 15 Analogue Outputs | | | |
| 1501 | A01 Content Select | Ext Ref 1 | Output Freq |
| Group 16 System Controls | | | |
| 1601 | Run Enable | DI3 | NOT SEL |
| Group 20 Limits | | | |
| 2003 | Max Current | 8.0 | 8.5 |
| 2007 | Minimum Freq | 0Hz | 0.0Hz |
| 2008 | Maximum Freq | 60Hz | 60.0Hz |
| Group 34 Panel Display | | | |
| 3415 | Signal 3 Parameters | DI1-3 Status | Torque |

Variable Frequency Drive Parameters For 18' Tower, 460V/3-Phase

| Parameter Number | Description | M-C Setting | Factory Default |
|--|-----------------------|---------------|-----------------|
| Group 99 Start Up Data | | | |
| 9901 | Language | English | English |
| 9902 | Applied Macro | ABB Standard | None |
| 9904 | Motor Control Mode | Scalar - Freq | Scalar - Freq |
| 9905 | Motor Nominal Voltage | 460 | NA |
| 9906 | Motor Nominal Current | 3 | NA |
| 9907 | Motor Nominal Freq | 60 | 60.0 |
| 9908 | Motor Nominal Speed | 1735 | 1710 |
| 9909 | Motor Nominal Power | 2Hp | 3Hp |
| Group 10 Start / Stop / Direction | | | |
| 1001 | Ext 1 Command | DI1 | DI1,2 |
| 1003 | Direction | Forward | Request |
| Group 11 Reference Select | | | |
| 1104 | Reference 1 Minimum | 0Hz | 0Hz |
| 1105 | Reference 1 Maximum | 60Hz | 60Hz |
| Group 12 Constant Speeds | | | |
| 1201 | Constant Speed Select | DI4,5 | DI3,4 |
| Group 14 Relay Outputs | | | |
| 1407 | RO 2 Off Delay | 30 Sec | 0 Sec |
| Group 15 Analogue Outputs | | | |
| 1501 | A01 Content Select | Ext Ref 1 | Output Freq |
| Group 16 System Controls | | | |
| 1601 | Run Enable | DI3 | NOT SEL |
| Group 20 Limits | | | |
| 2003 | Max Current | 4.5 | 8.5 |
| 2007 | Minimum Freq | 0Hz | 0.0Hz |
| 2008 | Maximum Freq | 60Hz | 60.0Hz |
| Group 34 Panel Display | | | |
| 3415 | Signal 3 Parameters | DI1-3 Status | Torque |









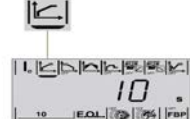

Changing Variable Frequency Drive Parameters

1. To go the Main menu, press  if the bottom line shows OUTPUT; otherwise press  repeatedly until you see MENU at the bottom
2. Press **Keys** /  until you see "PAR" and press .
3. Find the appropriate parameter group with **Keys** /  and press .
4. Find the appropriate parameter group with **Keys** / .
5. Press and hold  for about two seconds until the parameter value is show with **SET** under the value.
6. Change the value with keys / . The value changes faster while you keep the key pressed down.
7. Save the parameter value by pressing .

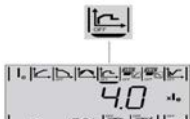

Soft Starter Parameters

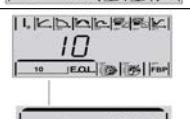
The purpose of the soft starter is to control the ramp speed of the fan motor in order to reduce the stress the motor experiences during startup . The table below is the M-C settings that comes standard from the M-C factory.

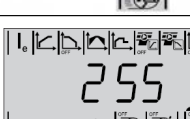
| Description | Display Symbol | ABB Default | M-C Setting |
|---|---|------------------------------------|------------------------------------|
| Rated Current of Motor (Ie) |  | Individual | Noted Motor Namplate |
| Start Ramp Time |  | 10 s | 30 s |
| Stop Ramp Time |  | OFF | OFF |
| Initial/End Voltage |  | 30% | 30% |
| Current Limit |  | 4.0 x Ie | 7.0 x Ie |
| Torque Control During Start Ramp |  | OFF | OFF |
| Torque Control During Stop Ramp |  | ON | ON |
| Kick Start |  | OFF | OFF |
| Electronic Overload Protection (EOL) Tripping Class Type of Operation |  | 10 HAnd Auto | 20/30 HAnd Auto |
| Underload Protection Level Type of Operation |  | OFF HAnd Auto | OFF HAnd Auto |
| Locked Rotor Protection Level Type of Operation |  | OFF HAnd Auto | 7.0 x Ie HAnd Auto |
| Fieldbus Control Fieldbus Address Download Parameter Operation When Fault Type of Operation |  | OFF 255 dPon LocC Hand | OFF 255 dPon LocC Hand |



Navigating Soft Starter Parameters

The menu is navigated by the keypad. The Navigation keys are used to scroll up or down. The Select key is used to select a setting and save. The Exit key is used to cancel without selecting or saving a setting, and go to a higher level of the menu, as illustrated in the figure below.

1. Turn on the backlight by pressing any key.
2. On the Information level use the Navigation keys for scrolling the different operational information.
3. Press the Select key to Enter the Settings level. See (A) on the figure on the follow page. A cursor is marking the accessible parameter, in this case Rated Current I_e .
4. Press Select key again to enable editing of the paramter Rated Current. See (B) on the figure on the following page. A flashing value on the middle row indicats that the parameter is available for scrolling and for selection.
5. Increase or decrease the value by pressing Navigation key repeatedly. Holding the key down will speed up the scrolling. See (C) on the figure on the following page.
6. When the rated current of the motor is reached, press the Select key again to save. See (D) on the figure on the following page.
7. It is possible to select and adjust the other parameters by following the same procedure.
8. At any point, press Exit to cancel a setting, and return to the information level.

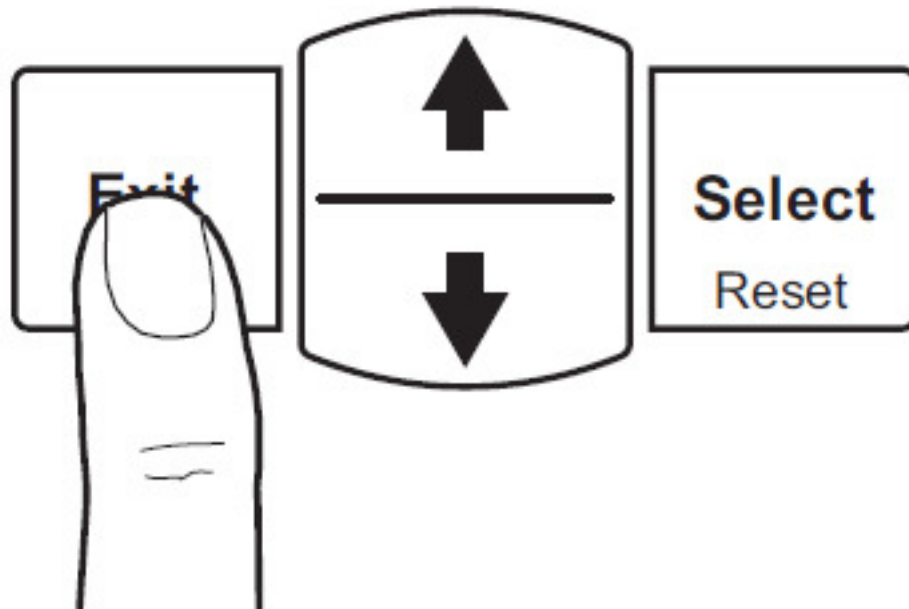

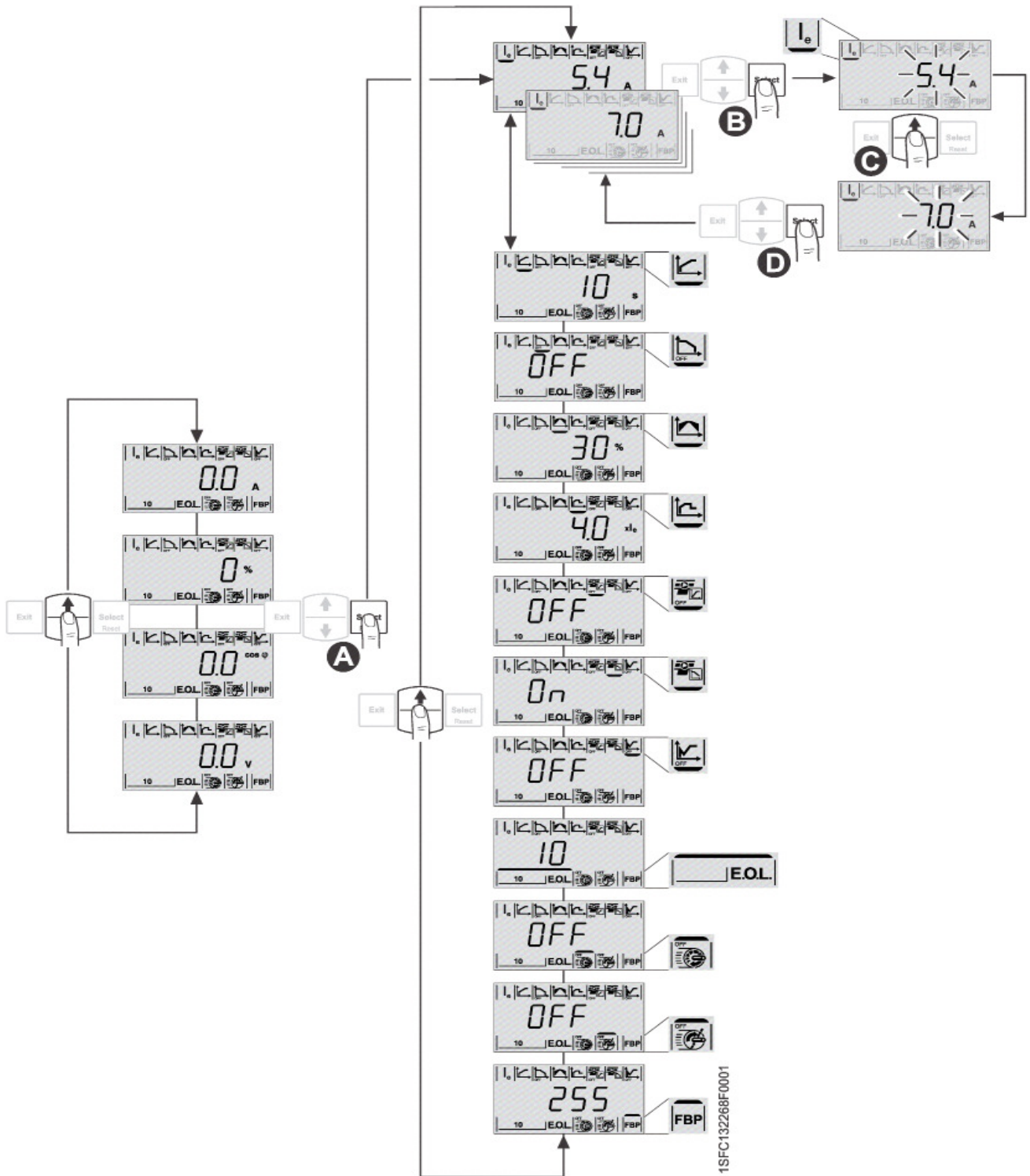

Operational Procedures

The following operational procedures provide a step-by-step guide to starting-up and shutting-down your Pinnacle 20|20 equipped dryer only. These procedures should be followed and used in conjunction with the Pinnacle 20|20 Controls Manual for HMI touchscreen adjustments.

First Time Start-Up

This start-up procedure assumes that the dryer has not recently been in operation and is not full of grain. For a repeated daily start-up, see the Daily Start-Up procedure portion of this section of the manual.

1. Adjust the high limit switch setpoint to approximately 40 deg F above the desired plenum temperature as explained in the High Limit portion of this section of the manual. This should be done for all plenum high limit switches.
2. Set the grain fill timers as explained in the Settings Chapter of the Pinnacle 20|20 Controls Manual.
3. Turn the main disconnect located on the High Voltage Cabinet to the on position.
4. On the Remote Cabinet, go to the Controls page on one of the HMI's and press the Control Power On button.
5. On the same Controls page, press the Fan START button. The fan should start immediately.
6. On the Remote Cabinet, go to the Grain Fill Settings page on one of the HMI's and check the "Fill From Empty" box. Next, press the Grain Fill START button.
7. Once the dryer is full of grain, adjust the air pressure switch(es) so the air pressure light illuminates as explained in the Air Pressure Switch portion of this section of the manual.
8. Set the plenum temperature setpoint. You may refer to the table that follows for suggested drying temperatures based on model number and grain type. Setting the plenum temperature can be done on the HMI touchscreens as explained in the Pinnacle 20|20 Controls Manual.
9. Open all manual gas supply valves so that fuel is free to flow to the burner once the gas valves controlled by the ignition system are opened.
10. On the Remote Cabinet, from the Controls page on one of the HMI's, press the Burner START button. After a 15 second delay, the burner should be lit.
11. Allow the dryer to warm up and dry the initial load of grain as a batch operation or be prepared to cycle the first batch back into the wet bin so that it may be processed through the dryer again on a continuous flow basis.
12. On the Remote Cabinet, from the Grain Fill Settings page on one of the HMI's, uncheck the Fill From Empty box. The grain fill system will now operate automatically as outlined in the Grain Fill Settings portion of the Pinnacle 20|20 Controls manual.
13. Refer to the Pinnacle 20|20 Controls Manual for the requirements prior to starting the dryer's discharge. At a minimum, set the discharge mode to Manual on the HMI touchscreen and set the discharge speed setpoint (%) in accordance with the table that follows.
14. On the Remote Cabinet, from the Control page on one of the HMI's, press the Discharge START button. Your sweep should start running. The dryer is now discharging grain and the discharge rate will be established by the Pinnacle 20|20 Control System. Refer to the Pinnacle 20|20 Controls Manual for more information.

Daily Shut-Down

This shutdown procedure assumes that the dryer will be put back into operation within 24-48 hours. If the grain drying operation will not resume within 24-48 hours, it is suggested that the dryer be emptied and the grain placed back into the appropriate storage. Grain dryers are not designed to be grain storage devices. Once all the grain has been dried, it needs to be emptied from the dryer and stored appropriately. Grain stored in a dryer for more than one week may cause damage to the machine. For an end-of season shut-down procedure, see the End-of-Season Shut Down portion of this section of the manual.

1. On the Remote Cabinet, from the Controls Page on one of the HMI's, press the Discharge Stop button. The sweep system as well as your takeaway equipment should be stopped after the discharge timers have expired.
2. On the same Controls page, press the Grain Fill Stop button. The grain fill system will now be shutdown and your fill equipment will no longer be commanded to run.
3. Close the manual hand valves supplying fuel to the dryer. This will ensure the burner will run until all of the fuel in the line has been cleared out. Once the burner is extinguished, from the Controls page on one of the HMI's, press the Burner Stop button.
4. Let the fan(s) continue to run for at least 15-20 minutes to cool the grain in the dryer. Once the grain has been cooled down, shutoff the fan(s) by pressing the Fan Stop button from the Controls page.
5. On the Remote Control Cabinet, from the Controls Page, press the Control Power TURN OFF button.
6. Turn the main disconnect located on the High Voltage Cabinet to the off position.



Daily Start-Up

This start-up procedure assumes that the dryer has recently been in operation and is full of grain. For a first time start-up, see the Daily Start-Up procedure portion of this section of the manual.

1. Turn the main disconnect located on the High Voltage Cabinet to the on position.
2. On the Remote Cabinet, go to the Controls page on one of the HMI's and press the Control Power On button.
3. On the same Controls page, press one of the Fan START buttons. The fan should start immediately.
4. Set the plenum temperature setpoint. You may refer to the table that follows for suggested drying temperatures based on model number and grain type. Setting the plenum temperature can be done on the HMI touchscreens as explained in the Pinnacle 20|20 Controls Manual.
5. Open all manual gas supply valves so that fuel is free to flow to the burner once the gas valves controlled by the ignition system are opened.
6. On the Remote Cabinet, from the Controls page on one of the HMI's, press the Burner START button. After a 15 second delay, the burner should be lit.
7. On the Remote Cabinet, from the Grain Fill Settings page on one of the HMI's, uncheck the Fill From Empty box. The grain fill system will now operate automatically as outlined in the Grain Fill Settings portion of the Pinnacle 20|20 Controls manual.
8. Refer to the Pinnacle 20|20 Controls Manual for the requirements prior to starting the dryer's discharge. At a minimum, set the discharge mode to Manual on the HMI touchscreen and set the discharge speed setpoint (%) in accordance with the table that follows.
9. On the Remote Cabinet, from the Control page on one of the HMI's, press the Discharge START button. The dryer is now discharging grain and the discharge rate will be established by the Pinnacle 20|20 Control System. Refer to the Pinnacle 20|20 Controls Manual for more information.
10. Adjust the free-air, cooling section, dampeners. Closed dampeners will create the suction of air from the outside ambient air towards the inside of the dryer via the grain column. This will cool grain at the bottom of the dryer, and lower the discharge grain temperatures; This will also lower the discharge capacity of the dryer in-turn. Open dampeners will improve dryer capacity, but raise the temperature of the discharged grain.

End-of-Season Shut-Down

This shutdown procedure assumes that the dryer will not be put back into operation for an extended period of time and that all of the grain in the dryer will be dried and then subsequently emptied.

1. When the last of the grain to be dried has been put into the dryer, turn the Metering switch and the Takeaway switch to the OFF position on the Remote Control Cabinet. Both switches should no longer be illuminated, the sweep system as well as your takeaway equipment should be stopped.
2. Dry the remaining grain for approximately six minutes per point of moisture to be removed.
3. Close the manual hand valves supplying fuel to the dryer. This will ensure the burner will run until all of the fuel in the line has been cleared out. Once the burner is extinguished, from the Controls page on one of the HMI's, press the Burner Stop button
4. Let the fan(s) continue to run for at least 15-20 minutes to cool the grain in the dryer. Once the grain has been cooled down, shutoff the fan(s) by going to the Controls page on one of the HMI's, and press

the Fan Stop button.

5. Set the discharge mode to Manual on one of the HMI touchscreens and set the discharge speed setpoint (%) as high as your takeaway system will allow.
6. On the Remote Cabinet, from the Control page on one of the HMI's, press the Discharge START button. The discharge auger or conveyor (if equipped) should start immediately, and your takeaway equipment should start running. After the Metering Start Delay timer has expired, the metering rolls will start as explained in the Pinnacle 20|20 Controls manual. The dryer is now discharging grain and the discharge rate will be established by the Pinnacle 20|20 Control System. Refer to the Pinnacle 20|20 Controls Manual for more information.
7. Allow the grain to be completely emptied from the dryer.
8. On the Remote Cabinet, from the Control page on one of the HMI's, press the Discharge STOP button. The sweep system as well as your takeaway equipment should be stopped after the timers have expired.
9. On the Remote Control Cabinet, from the Controls Page, press the Control Power TURN OFF button.
10. Turn the main disconnect located on the High Voltage Cabinet to the off position.
11. Refer to the Maintenance section of this manual for additional information on preparing your dryer for an extended shutdown.



Suggested Plenum Temperatures

Below are suggested plenum drying temperatures for a variety of grain types. These numbers represent the plenum temperature within the heat chamber.

| Model Number | Plenum Number | Plenum Drying Temperature | | | |
|------------------|---------------|---------------------------|-------|-----------------|-------|
| | | Corn | | Sorghum & Wheat | |
| | | deg F | deg C | deg F | deg C |
| All Tower Dryers | N/A | 210 | 99 | 150 | 66 |

Suggested Discharge Rate

Below are suggested discharge rates when drying at different of moisture levels. These numbers represent how fast or how slow the dryer unloads the grain.

| | Heat + Cool | | | | | |
|-----------|------------------|-----------|-------|------------------|-----------|-------|
| | 20%-15% Moisture | | | 25%-15% Moisture | | |
| | bu/hr | tonnes/hr | speed | bu/hr | tonnes/hr | speed |
| 10530 | 700 | 16.3 | 34% | 400 | 9.3 | 19% |
| 10740 | 930 | 21.7 | 32% | 540 | 12.6 | 19% |
| 10950 | 1,240 | 28.9 | 33% | 720 | 16.8 | 19% |
| 101160 | 1,500 | 34.9 | 33% | 870 | 20.3 | 19% |
| 101375 | 1,700 | 39.6 | 32% | 1,000 | 23.3 | 19% |
| 12-20-100 | 2,000 | 46.6 | 48% | 1,160 | 27.0 | 28% |
| 12-24-125 | 2,400 | 55.9 | 48% | 1,390 | 32.4 | 28% |
| 12-28-150 | 2,800 | 65.2 | 48% | 1,620 | 37.7 | 28% |
| 3000 | 3,000 | 69.9 | 50% | 1,800 | 41.9 | 30% |
| 3500 | 3,500 | 81.5 | 52% | 2,100 | 48.9 | 31% |
| 4000 | 4,000 | 93.2 | 54% | 2,400 | 55.9 | 32% |
| 4800 | 4,800 | 111.8 | 59% | 2,800 | 65.2 | 34% |

Maintenance

Overview

This section of the manual will explain the factory recommended maintenance and cleaning requirements to keep your Mathews Company grain dryer running efficiently. Failure to follow or comply with these recommendations will impact dryer performance and may limit or void your warranty.

Pre-Season Checks

The following pre-season checks are intended to prepare your dryer for operation and bring any issues that may be present to your attention. Performing these check no later than 1-2 months before you intend to use the machine is recommended so that proper service can be performed and/or replacement parts can be ready before the harvest season begins.

Grain Fill & Discharge System

The following procedure will guide you through the grain fill and discharge system pre-season check. If the results of any of the following procedures are not consistent with what you should observe, service and/or replacement parts may be required. Contact your dealer or refer to the Troubleshooting section of this manual for more information.

1. Turn all of the circuit breakers in the cabinet on. Turn the electric power supply to the dryer on.
2. On the Remote Control Cabinet, turn Power On through one of the HMI's by pressing the Control Power Turn On button on the Controls page. The button should read ON and be illuminated green with a surrounding glow.
3. On the same Controls page, press the Grain Fill START button.
4. On the same Controls page, press the Discharge START button.
5. After the Metering Start Delay timer expires, the sweep should start turning.



Fans & Burners

The following procedure will guide you through the fan and burner system pre-season check. If the results of any of the following procedures are not consistent with what you should observe, service and/or replacement parts may be required. Contact your dealer or refer to the Troubleshooting section of this manual for more information.

1. Turn the electric power supply to the dryer off.
2. Close the burner gas manifold hand valve (handle 90° relative to the piping).
3. In order to test the burners without grain in the dryer, the air pressure switches will need to be jumpered. To do this, place a jumper between terminal 343 (power) and 812 (air pressure switch 1) to jumper air pressure switch 1. To jumper the other air pressure switches on an 18' tower, place the jumper between 343 and the following terminals respectively: 822 and 832.



This is only a temporary procedure for checking the burner. Under normal operation, never operate the dryer with the air pressure switches disconnected or bypassed. This safety air pressure switch is for your protection and the protection of the dryer.

4. Open all manual gas supply valves so that fuel is free to flow to the burner once the gas valves controlled by the ignition system are opened.
5. Turn the electric power supply to the dryer on.
6. On the Remote Control Cabinet, turn Power On through one of the HMI's by pressing the Control Power TURN ON button on the Controls page. The button should read ON and be illuminated green with a surrounding glow.
7. On the same Controls page, press the Fan START button. The Fan should start immediately and the air pressure light should illuminate.
8. Open the manual gas valve 1/4 of the way open to control the fuel flow to the burner once it has been lit
9. On the same Controls page, press the Burner START button. The burner should go through it's sequence and light.
10. Let the burner run for at least two minutes to verify that it is properly operating.



Lubrication

Maintaining proper lubrication of all moving components of your dryer is key to its efficient and safe operation. The following table below outlines all recommended lubrication. Note that some of the items may not be applicable based on configured options, model or accessories.

| Item | Lubrication Required | Interval |
|-----------------------------|---|---|
| 50:1 Gearbox Oil Level | Fill 1/4" over gear with SAE 90 gear lubricant | Maintain proper level. Check every 100 hours |
| 50:1 Gearbox Grease Fitting | Uses (5) strokes of gun grease | At the beginning and end of the season. |
| Universal Joints | Use (1) strokes of gun grease | Every 50 hours of operation. |
| Motors | Lubricate with SR-2 (Chevron) grease or equivalent | Prior to operation and at the end of the season. |
| Motor Bearings | Use Exxon Corp-Plyres-em product or Chevron, Inc-SRI#2. Grease should be lithium based. | At the beginning and the end of the season. |
| Centrifugal Fan Bearings | Use only #2 consistency lithium based grease with high quality mineral oil with rust and oxidation inhibitor. Use Shell Alvania #2 Mobil Mobilux #2 or Texaco Multifak #2 | At the beginning of the season and every 100 hours until the end of the season. |

Seasonal Cleaning

During the course of the drying season, it is important to keep the dryer operating at its peak efficiency by performing periodic maintenance and cleaning of the equipment. When the screens of a dryer are clean, the air moves freely through the grain walls. As debris builds up inside the dryer, this can result in the combustion of debris which may lead to a fire. As such, cleaning of the grain dryer should be performed on a daily basis. Try to keep the surroundings of the dryer clean at all times to prevent breeding grounds for insects and other pests.

The recommended method for cleaning the dryer is air or water, preferably from a compressed-air source or even a vacuum, however, using a non-metallic brush or broom also works. Be aware that if using water to clean the dryer, the combination of water and residue can form a paste, making the surfaces sticky and more difficult to remove.

Inverted Roof

Be sure to check and clean the inverted roof by removing the inverted roof panel for access. Cleaning should be done daily and includes vacuuming all debris inside the inverted cone and on top of the shelf where the inverted cone attaches.



Outer Screens

The outer screens of the dryer need to be kept as clean as possible for safety and performance reasons. The perforation of the screens allow heated air, saturated with moisture from the grain, to exit to the atmosphere. This process also creates a damp environment on the outside of the screens, creating a buildup of fines and dust which reduces air flow resulting in a decrease of capacity and higher cost of drying.

Cleaning of the outer screens can be done during the drying process, but it may temporarily affect the discharge capacity if water is used. The preferred way to clean is to brush down the screens while grain is being dried as this will help push material out of the perforations in the screens. The discharge rate should increase after cleaning of the dryer because more surface area is now being exposed to the heated air passing through the grain columns.

Inner Screens

The procedure for cleaning the inner screens is similar to that of cleaning the outer screens. When cleaning the inside of the dryer, the use of a protective breathing mask is recommended. Using a non-metallic brush or broom, sweep the inner screens and channel rings going from top to bottom. Check the burner to make sure the wires look good and the burner is clean of debris. Sweep the plenum floors and remove any debris.

Post-Season Maintenance

After the drying season, the following steps are recommended to put your dryer into a condition suitable for an extended period of non-operational time.

1. Disconnect all power and turn off the gas supply.
2. Perform one final cleaning of the dryer inside and out as previously explained in the Seasonal Cleaning section of the manual. Use a power washer on the outer screens if dirt has filled the perforations on the screens.
3. Open the plenum access doors and sweep out all foreign material.
4. Visually inspect all bearings to see if there is indication of one in need of replacement.
5. Grease all fan motor bearings and fan bearings as recommended in the Lubrication section of the manual.
6. Use a vacuum cleaner to remove any dirt from the control cabinet.



Troubleshooting

The Troubleshooting section will help with diagnosing the dryer in case of a dryer shut down. This section will explain common situations that may arise and will help come up with a resolution to get the dryer back to operation.

Diagnosing a Dryer Shutdown

The safety of your dryer is in the hands of the safety circuit. These are a series of components that are tied together. If one fails the system will shutdown insuring the safety of your grain dryer.

Safety Circuit Overview

The contacts for incoming hot and neutral are found in the High Voltage cabinet.

The 120 volt input power to the dryer circuit for dryer controls comes from the bottom side of the transformer and runs to the top of the 8 amp mini-breaker. This breaker should be turned off and the voltage should be checked before turning the mini-breaker on. If the voltage reads anything outside of 125-volts, the supply voltage needs to be checked before powering on the mini-breaker.

Next to the mini breaker is a neutral block, which feeds all neutrals throughout the entire dryer. This neutral is connected to the neutral from the secondary side of the transformer that is standard equipment.

The incoming neutral line is connected to **TB5** (white wire) and the hot line is on **TB33** (after circuit breaker). The incoming 120-volt supply is an 8 amp mini-breaker.

The Safety Circuit can be viewed on page 4 and 5 of the electrical schematics. Page 4 is the Dryer Control or Fault Control portion of the Safety Circuit while page 5 of the electrical schematics contains the Dryer Safety, or Human Safety portion of the Safety Circuit. Components associated with the Dryer Control, or Fault Control portion of the Safety Circuit include the Fan Motor Overloads, High Limit Switches Linear Limits (if equipped) and Gas Pressure Switches for export model dryers. The components associated with the Dryer Safety, or Human Safety portion of the Safety Circuit are the E-Stops, Safety Relay and Plenum Door Switches for export dryers.

There are two ways to troubleshoot the Safety Circuit. One is through the Safety Circuit page of the Pinnacle 20|20 control while the other involves use of a voltmeter.

Diagnosing Safety Circuit Via HMI

Before diagnosing the Safety Circuit, it is recommended to have a good understanding of the Pinnacle 20|20 Control. The Pinnacle 20|20 Control features a tab on the home page titled Troubleshooting. Pressing this tab populates different options. One of these options is the Safety Circuit tab. Pressing the Safety Circuit tab will bring up a page that visually illustrates the Safety Circuit and all associated components. To troubleshoot the disruption of the Safety Circuit, look for the component on the page that has a grayed out globe next to it as opposed to a green globe. Green globes indicate that the component and that particular part of the Safety Circuit is good. A grayed out globe indicates that the break in the Safety Circuit is associated with that particular component. One thing to note is that the High Limits and Motor Overloads are wired in



series respectively. Meaning, if one of the High Limits or Motor Overloads are tripped, all the High Limits or Motor Overloads proceeding the tripped one will appear on the Safety Circuit screen tripped as well. So the first High Limit or Motor Overload that appears with the grayed out globe should be addressed first as it is very likely that once addressed, all that follow may be good as well. For more information on diagnosing the Safety Circuit via the HMI, see the Pinnacle 20|20 controls manual.

Diagnosing Safety Circuit With a Voltmeter

The Safety Circuit can also be diagnosed by using a DC voltmeter and the dryer schematic. Using the schematic as a guide, use the voltmeter to look for 24 vdc at terminals in the Low Voltage Cabinet. Be sure the Voltmeter is first set to read DC Voltage which is depicted with a straight line next to the V as opposed to a wavy line which depicts AC voltage. Take the black lead of the Voltmeter and place it in Terminal 320 (TB320). Next, move the red lead of the voltmeter to the first terminal of the Safety Circuit (TB341), followed in order by TB401 as shown below until 24 Volts no longer appears and 0 Volts measures on the Voltmeter instead.

| | |
|-------|---|
| TB341 | Beginning of the safety circuit after circuit breaker #341. |
| TB401 | Fan protector #1 (Start up protector for 18' towers) |
| TB402 | Fan protector #1 (18' Towers only) |
| TB403 | Fan protector #2 (18' Towers only) |
| TB404 | Fan protector #3 (18' Towers only) |
| | |
| TB421 | High limit #1 |
| | |
| TB431 | Linear Limit #1 |
| TB432 | Linear Limit #2 |
| TB433 | Linear Limit #3 (12' and 18' Towers only) |
| TB434 | Linear Limit #4 (12' and 18' Towers only) |
| TB435 | Linear Limit #5(18' Towers only) |
| TB436 | Linear Limit #6 (18' Towers only) |

Note: If there is 24 vdc at terminal #460, the safety circuit is complete.

All dryers have “E-Stops” and have the option of a “Customer E-Stop” that if tripped, will disengage the safety circuit. To check, visually inspect if any of these red E-Stop buttons are depressed:

Remote cabinet

Low voltage cabinet

High voltage cabinet

Customer E-Stop (Optional, provided by customer)

Safety Circuit Schematic

Below is the Dryer Control or Fault Control portion of the Safety Circuit. See page 4 of the electrical schematics to see this portion of the safety circuit that matches exactly to your particular dryer.

10' Tower Safety Circuit Schematic (Fault Control)

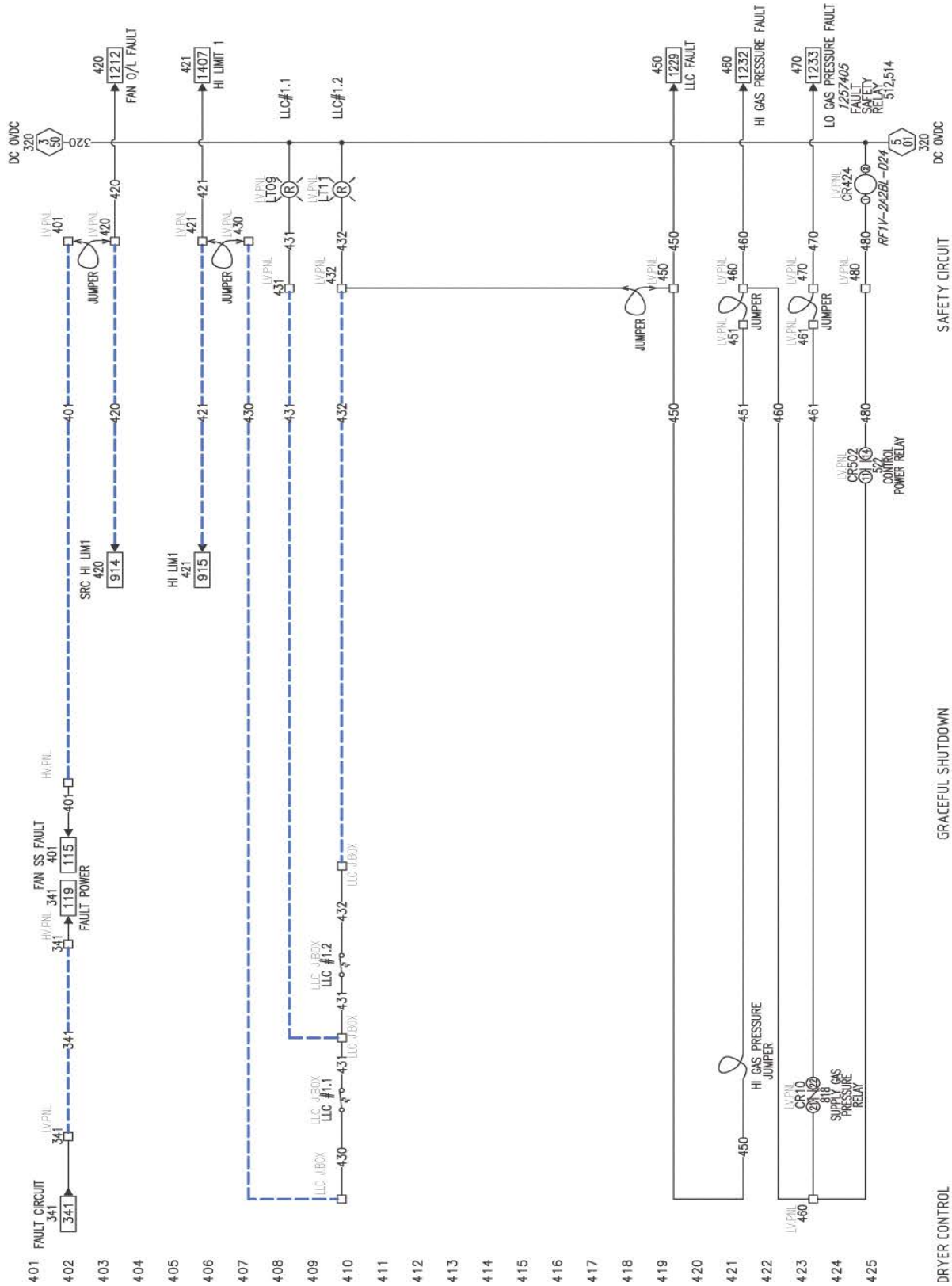

12' Tower Safety Circuit Schematic (Fault Control)

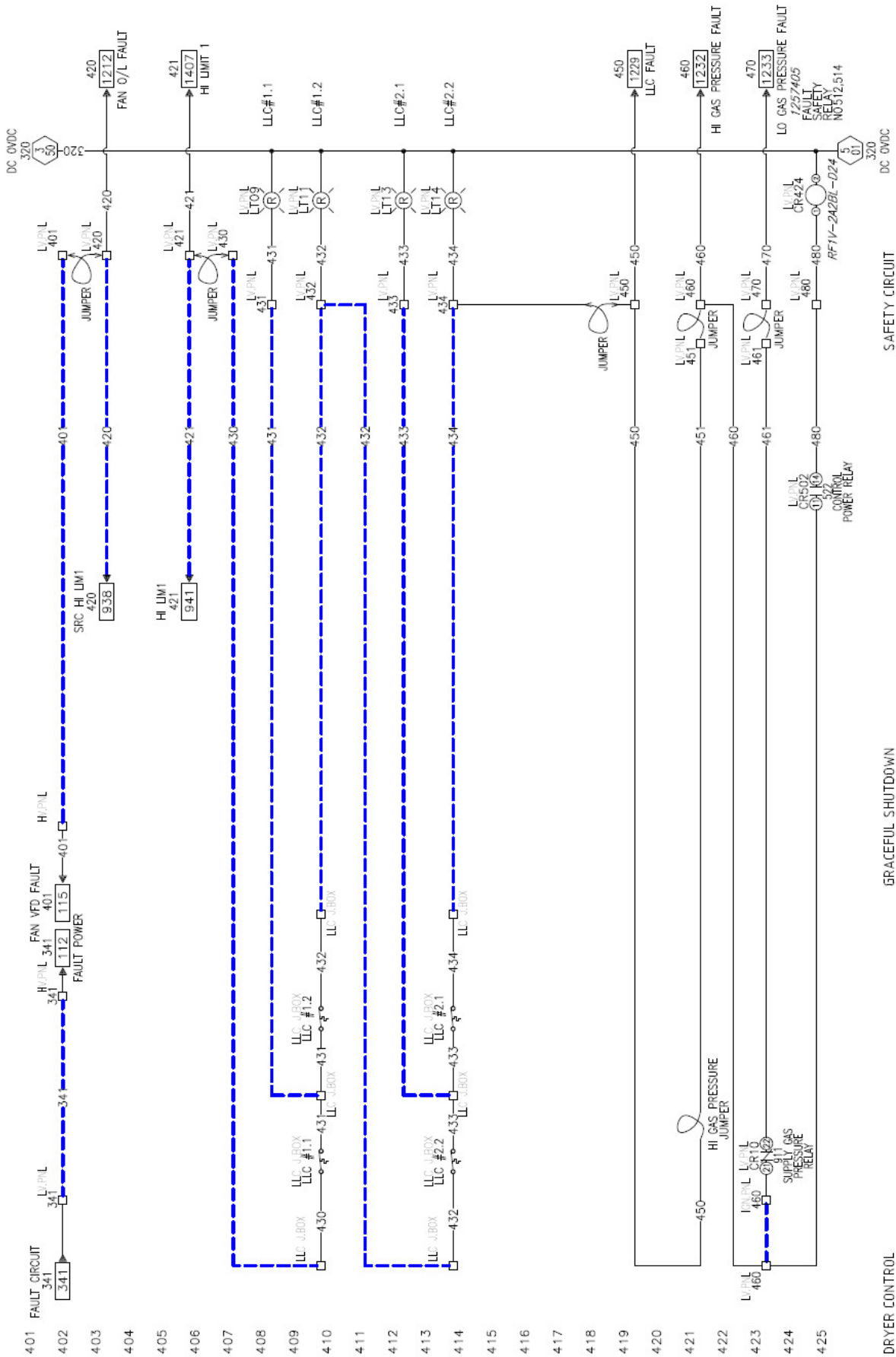

18' Tower Safety Circuit Schematic (Fault Control)

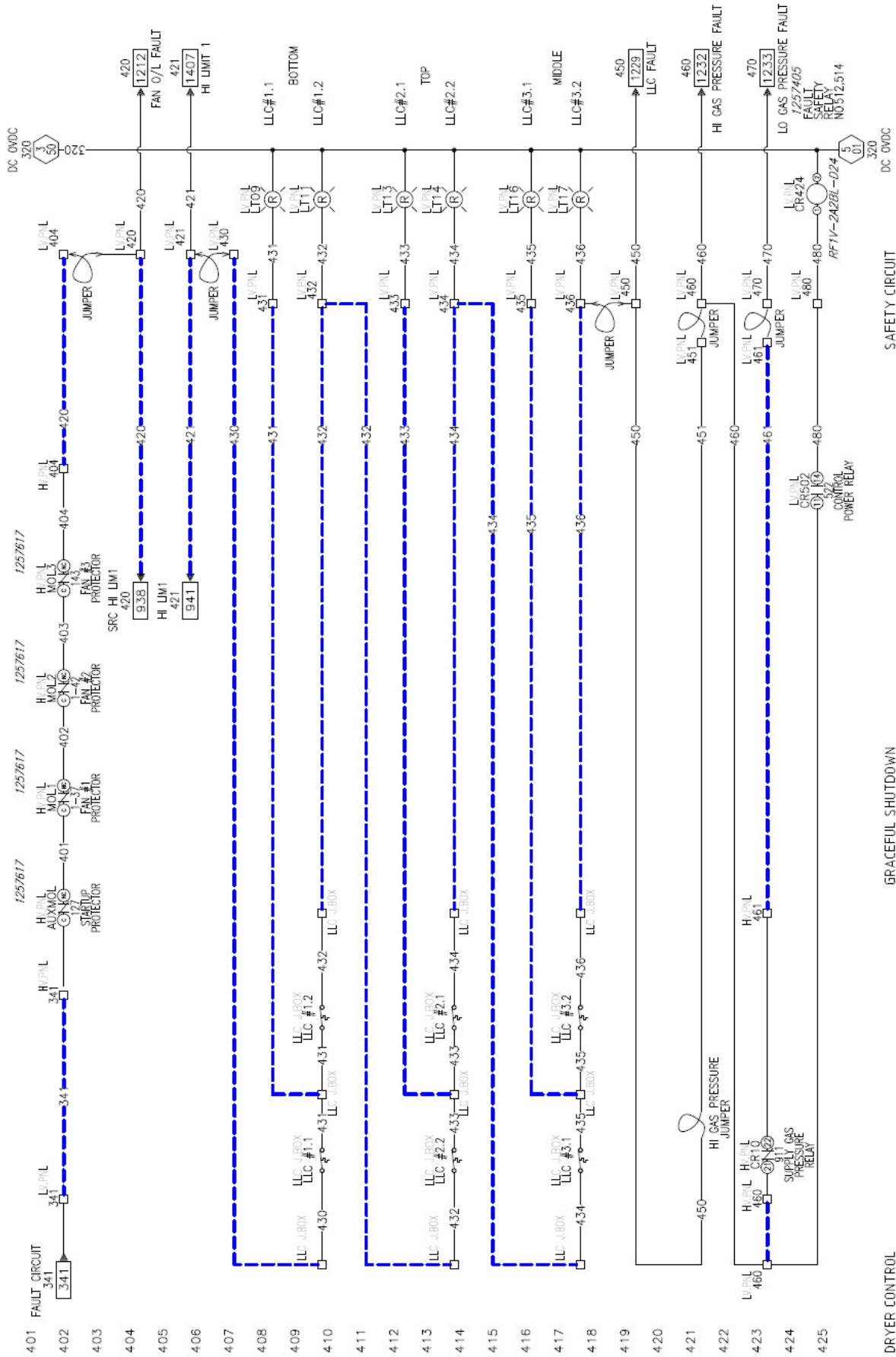

Safety Circuit Schematic

The second part of the safety circuit below will help diagnose a dryer shut down. This is the Dryer Safety or Human Safety portion of the Safety Circuit. See page 5 of the electrical schematics to see this portion of the safety circuit that matches exactly to your particular dryer.

10' Tower Safety Circuit Schematic (Human Safety)

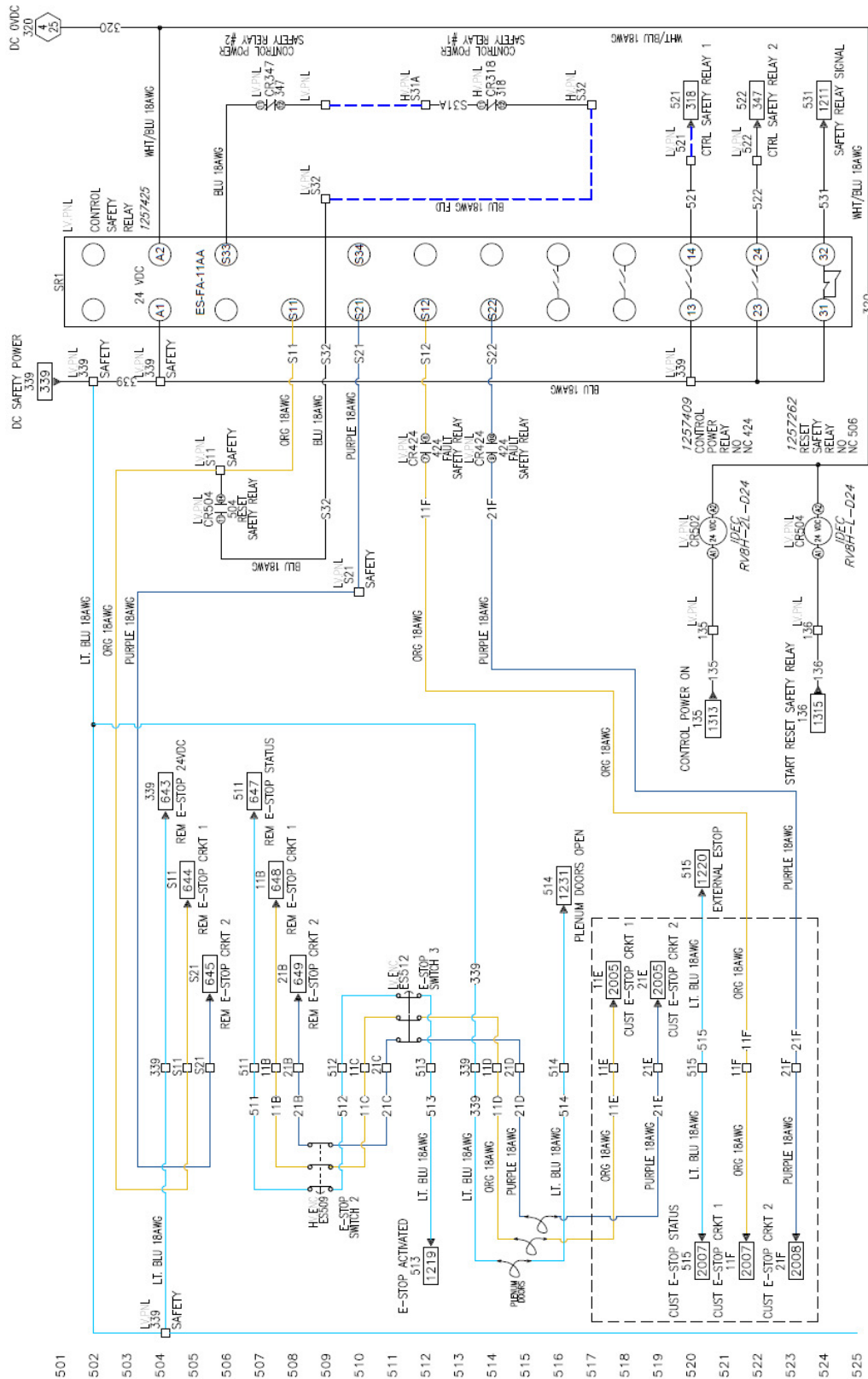

12' Tower Safety Circuit Schematic (Human Safety)

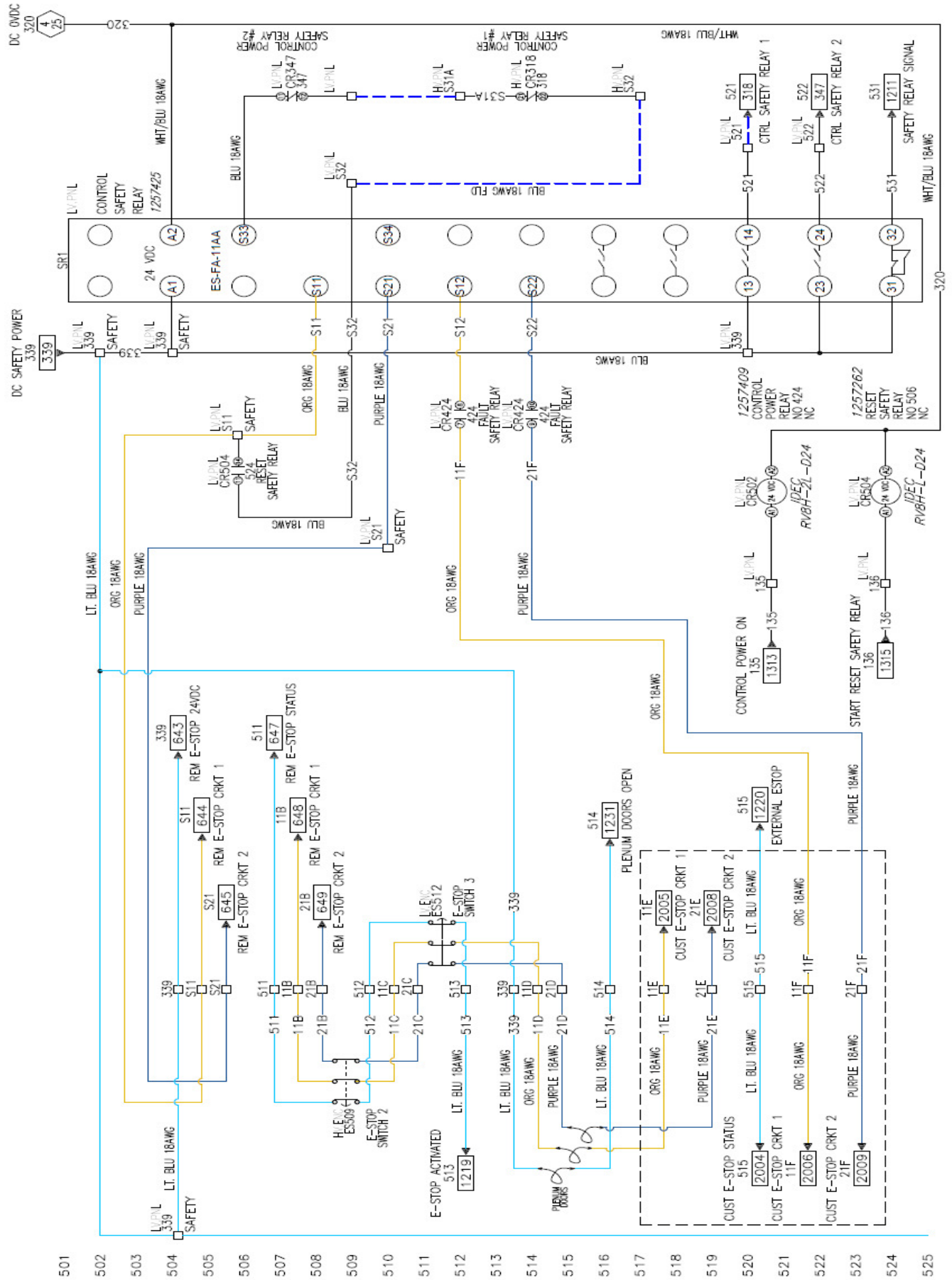

18' Tower Safety Circuit Schematic (Human Safety)

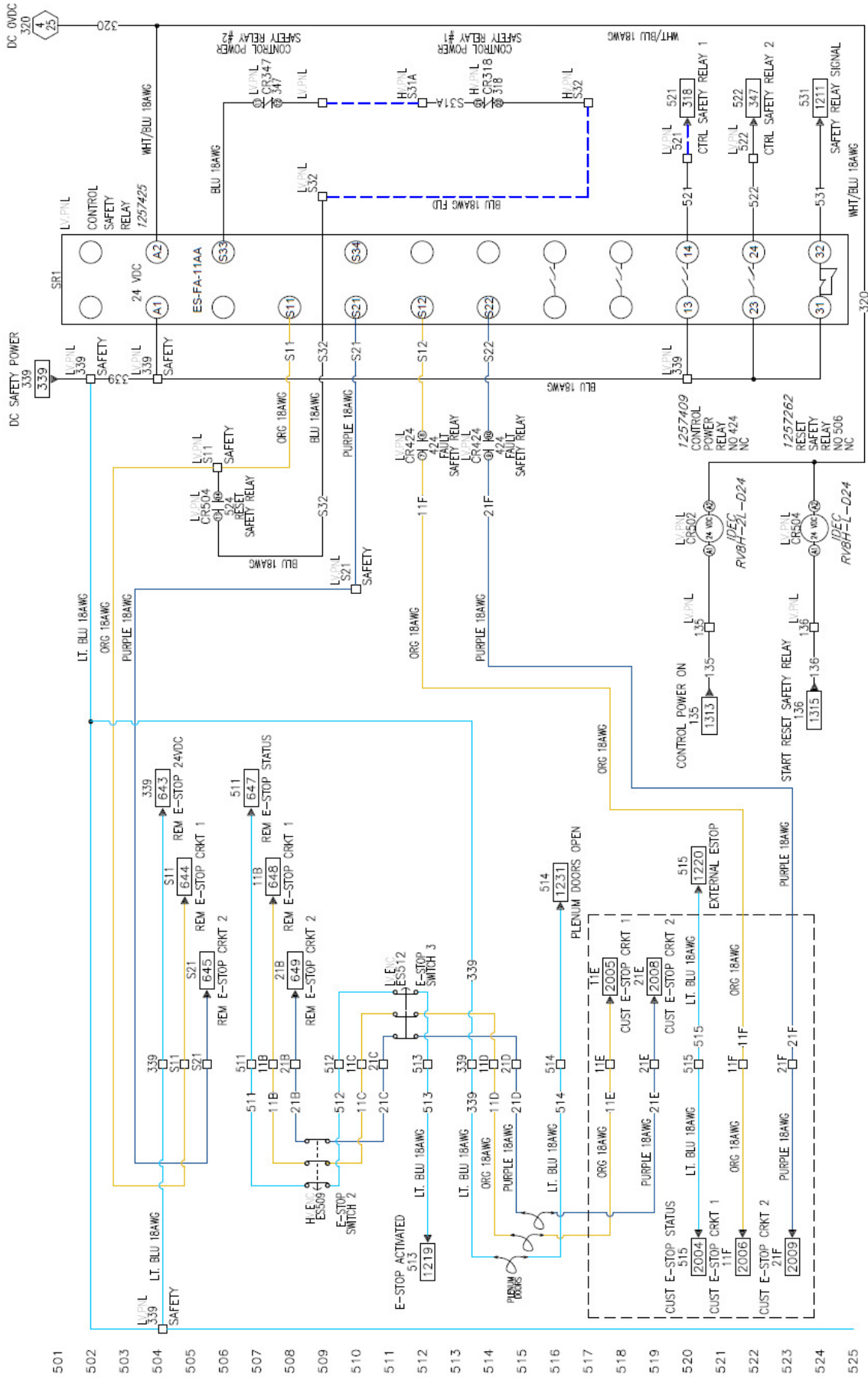

Customer Interface

Customer connections are for remote equipment, and are used to interface the grain dryer with fill and takeaway equipment. The grain dryer does not supply power for these interfaces. An auxiliary power source should be used to power customer equipment.

Fill Customer Connections

- **F1-F2** = Fill equipment status
- **F3-F4** = Fill 2 dry contacts
- **F5-F6** = Fill 1 dry contacts

F1-F2. **F1** and **F2** is a signal to the PLC confirming that customer fill equipment is not in a fault condition and can be started.

F3-F4. **F3** and **F4** are a dry set of contacts that close when the dryer fill cycle begins. When this closes, the dryer will start all the customer's equipment that is associated with Fill 2.

F5-F6. **F5** and **F6** are a dry set of contacts that close when the dryer fill cycle begins. When this closes, the dryer will start all the customer's equipment that is associated with Fill 1.

Takeaway Customer Connections

- **T1-T2** = Takeaway equipment status
- **T3-T4** = Takeaway 2 dry contacts
- **T5-T6** = Takeaway 1 dry contacts

T1-T2. **T1** and **T2** is a signal to the PLC confirming that customer takeaway equipment is not in a fault condition and can be started.

T3-T4. **T3** and **T4** are a dry set of contacts that close when the dryer discharge cycle begins. When this closes, the dryer will start all the customer's equipment that is associated with Takeaway 2.

T5-T6. **T5** and **T6** are a dry set of contacts that close when the dryer discharge cycle begins. When this closes, the dryer will start all the customer's equipment that is associated with Takeaway 1.

E-Stop Customer Connections

- **E1-E2** = Customer E-Stop status
- **E3-E4** = Safety Relay Circuit 1
- **E5-E6** = Safety Relay Circuit 2

E1-E2. **E1** and **E2** is a signal to the PLC confirming that all customer equipment included in the safety circuit are satisfied.

E3-E4. **E3** and **E4** breaks the 24V signal and initiates an emergency shutdown of the dryer.

E5-E6. **E5** and **E6** breaks the 24V signal and initiates an emergency shutdown of the dryer.

Note: *Breaking either E3/E4 or E5/E6 will result in the same emergency shutdown of the dryer.*



Variable Frequency Drive (VFD)

In the event that you run into an error code on the variable frequency drive (VFD), listed below are the display faults that will show up on the main display of the drive along with the description and recommended corrective action.

| Fault Code | Fault Name in Panel | Description and Recommended Corrective Action |
|------------|---------------------|--|
| 1 | OVERCURRENT | Output current is excessive. Check for and correct: <ul style="list-style-type: none"> Excessive motor load. Insufficient acceleration time (parameters 2202 ACCELER TIME 1 and 2205 ACCELER TIME 2). Faulty motor, motor cables or connections. |
| 2 | DC OVERVOLT | Intermediate circuit DC voltage is excessive. Check for and correct: <ul style="list-style-type: none"> Static or transient overvoltages in the input power supply. Insufficient deceleration time (parameters 2203 DECELER TIME 1 and 2206 DECELER TIME 2). Undersized brake chopper (if present). Verify that overvoltage controller is ON (using parameter 2005). |
| 3 | DEV OVERTEMP | Drive heatsink is overheated. Temperature is at or above limit. R1...R4: 115 °C (239 °F) R5, R6: 125 °C (257 °F) Check for and correct: <ul style="list-style-type: none"> Fan failure. Obstructions in the air flow. Dirt or dust coating on the heat sink. Excessive ambient temperature. Excessive motor load. |
| 4 | SHORT CIRC | Fault current. Check for and correct: <ul style="list-style-type: none"> A short-circuit in the motor cable(s) or motor. Supply disturbances. |
| 5 | RESERVED | Not used. |
| 6 | DC UNDERVOLT | Intermediate circuit DC voltage is not sufficient. Check for and correct: <ul style="list-style-type: none"> Missing phase in the input power supply. Blown fuse. Undervoltage on mains. |
| 7 | AI1 LOSS | Analog input 1 loss. Analog input value is less than AI1 FAULT LIMIT (3021). Check for and correct: <ul style="list-style-type: none"> Source and connection for analog input. Parameter settings for AI1 FAULT LIMIT (3021) and 3001 AI<MIN FUNCTION. |
| 8 | AI2 LOSS | Analog input 2 loss. Analog input value is less than AI2 FAULT LIMIT (3022). Check for and correct: <ul style="list-style-type: none"> Source and connection for analog input. Parameter settings for AI2 FAULT LIMIT (3022) and 3001 AI<MIN FUNCTION. |
| 9 | MOT OVERTEMP | Motor is too hot, based on either the drive's estimate or on temperature feedback. <ul style="list-style-type: none"> Check for overloaded motor. Adjust the parameters used for the estimate (3005...3009). Check the temperature sensors and Group 35: MOTOR TEMP MEAS parameters. |



| | | |
|----|--------------|---|
| 10 | PANEL LOSS | <p>Panel communication is lost and either:</p> <ul style="list-style-type: none"> • Drive is in local control mode (the control panel displays LOC), or • Drive is in remote control mode (REM) and is parameterized to accept start/stop, direction or reference from the control panel. <p>To correct check:</p> <ul style="list-style-type: none"> • Communication lines and connections. • Parameter 3002 PANEL COMM ERR. • Parameters in Group 10: START/STOP/DIR and Group 11: REFERENCE SELECT (if drive operation is REM). |
| 11 | ID RUN FAIL | <p>The Motor ID Run was not completed successfully. Check for and correct:</p> <ul style="list-style-type: none"> • Motor connections. • Motor parameters 9905...9909. |
| 12 | MOTOR STALL | <p>Motor or process stall. Motor is operating in the stall region. Check for and correct:</p> <ul style="list-style-type: none"> • Excessive load. • Insufficient motor power. • Parameters 3010...3012. |
| 13 | RESERVED | Not used. |
| 14 | EXT FAULT 1 | Digital input defined to report first external fault is active. See parameter 3003 EXTERNAL FAULT 1. |
| 15 | EXT FAULT 2 | Digital input defined to report second external fault is active. See parameter 3004 EXTERNAL FAULT 2. |
| 16 | EARTH FAULT | <p>Possible ground fault detected in the motor or motor cables. The drive monitors for ground faults while the drive is running and while the drive is not running. Detection is more sensitive when the drive is not running and can produce false positives.</p> <p>Possible corrections:</p> <ul style="list-style-type: none"> • Check for/correct faults in the input wiring. • Verify that motor cable does not exceed maximum specified length. • A delta grounded input power supply and motor cables with high capacitance may result in erroneous error reports during non-running tests. To disable response to fault monitoring when the drive is not running, use parameter 3023 WIRING FAULT. To disable response to all ground fault monitoring, use parameter 3017 EARTH FAULT. <p>Note: Disabling earth fault (ground fault) may void the warranty.</p> |
| 17 | OBSOLETE | Not used. |
| 18 | THERM FAIL | Internal fault. The thermistor measuring the internal temperature of the drive is open or shorted. Contact your local ABB representative. |
| 19 | OPEX LINK | Internal fault. A communication-related problem has been detected on the fiber optic link between the control and OINT boards. Contact your local ABB representative. |
| 20 | OPEX PWR | Internal fault. Exceptionally low voltage detected on the OINT power supply. Contact your local ABB representative. |
| 21 | CURR MEAS | Internal fault. Current measurement is out of range. Contact your local ABB representative. |
| 22 | SUPPLY PHASE | <p>Ripple voltage in the DC link is too high. Check for and correct:</p> <ul style="list-style-type: none"> • Missing mains phase. • Blown fuse. |



| | | |
|----|-----------------|---|
| 23 | ENCODER ERR | <p>The drive is not detecting a valid encoder signal. Check for and correct:</p> <ul style="list-style-type: none"> Encoder presence and proper connection (reverse wired = channel A connected to terminal of channel B or vice versa, loose connection or short circuit). Voltage logic levels are outside of the specified range. A working and properly connected Pulse Encoder Interface Module, OTAC-01. Wrong value entered in parameter 5001 PULSE NR. A wrong value will only be detected if the error is such that the calculated slip is greater than 4 times the rated slip of the motor. Encoder is not being used, but parameter 5002 ENCODER ENABLE = 1 (ENABLE). |
| 24 | OVERSPEED | <p>Motor speed is greater than 120% of the larger (in magnitude) of 2001 MINIMUM SPEED or 2002 MAXIMUM SPEED. Check for and correct:</p> <ul style="list-style-type: none"> Parameter settings for 2001 and 2002. Adequacy of motor braking torque. Applicability of torque control. Brake chopper and resistor. |
| 25 | RESERVED | Not used. |
| 26 | DRIVE ID | Internal fault. Configuration Block Drive ID is not valid. Contact your local ABB representative. |
| 27 | CONFIG FILE | Internal configuration file has an error. Contact your local ABB representative. |
| 28 | SERIAL 1 ERR | <p>Fieldbus communication has timed out. Check for and correct:</p> <ul style="list-style-type: none"> Fault setup (3018 COMM FAULT FUNC and 3019 COMM FAULT TIME). Communication settings (Group 51: EXT COMM MODULE or Group 53: EFB PROTOCOL as appropriate). Poor connections and/or noise on line. |
| 29 | EFB CON FILE | Error in reading the configuration file for the embedded fieldbus. |
| 30 | FORCE TRIP | Fault trip forced by the fieldbus. See the fieldbus User's Manual. |
| 31 | EFB 1 | <p>Fault code reserved for the embedded fieldbus (EFB) protocol application. The meaning is protocol dependent.</p> |
| 32 | EFB 2 | |
| 33 | EFB 3 | |
| 34 | MOTOR PHASE | <p>Fault in the motor circuit. One of the motor phases is lost. Check for and correct:</p> <ul style="list-style-type: none"> Motor fault. Motor cable fault. Thermal relay fault (if used). Internal fault. |
| 35 | OUTP WIRING | <p>Possible power wiring error detected. When the drive is not running it monitors for an improper connection between the drive input power and the drive output. Check for and correct:</p> <ul style="list-style-type: none"> Proper input wiring – line voltage is NOT connected to drive output. The fault can be erroneously declared if the input power is a delta grounded system and motor cable capacitance is large. This fault can be disabled using parameter 3023 WIRING FAULT. |
| 36 | INCOMPATIBLE SW | <p>The drive cannot use the software.</p> <ul style="list-style-type: none"> Internal fault. The loaded software is not compatible with the drive. Call support representative. |



| | | |
|---------------|-----------------|---|
| 37 | CB OVERTEMP | <p>Drive control board is overheated. The fault trip limit is 88 °C. Check for and correct:</p> <ul style="list-style-type: none"> • Excessive ambient temperature. • Fan failure. • Obstructions in the air flow. <p>Not for drives with an OMIO control board.</p> |
| | | |
| 38 | USER LOAD CURVE | Condition defined by parameter 3701 USER LOAD C MODE has been valid longer than the time defined by 3703 USER LOAD C TIME. |
| 101... 199 | SYSTEM ERROR | Error internal to the drive. Contact your local ABB representative and report the error number. |
| 201... 299 | SYSTEM ERROR | Error in the system. Contact your local ABB representative and report the error number. |



Soft Starter Fault Codes

In the event that you run into an error code on the soft starter, listed below are the display faults that will show up on the main display of the unit.

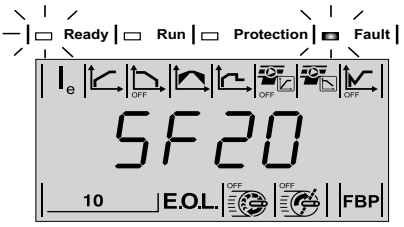
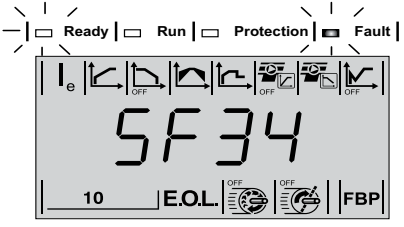
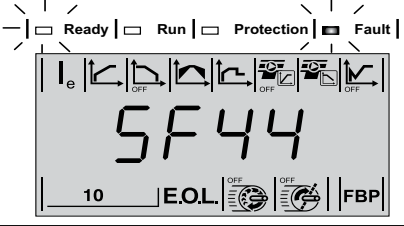
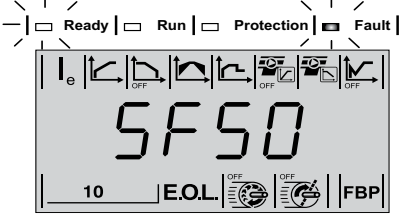
| Status | Possible cause | Solution |
|---|---|--|
| Software fault Red Fault LED steady lighting or flashing, and LCD event code SF20. See chapter 6.1.2.1 about LED status indicators activation for faults and protections. | Fault in software. | <ul style="list-style-type: none"> Disconnect and reconnect the control supply voltage (U_c) and make a re-start. See chapter 5.2.4. If same fault remains, contact your ABB Sales Office. |
|  <p>The LCD display shows the fault code SF20. Above the display are indicators for Ready, Run, Protection, and Fault. Below the display are indicators for 10, E.O.L., and FBP.</p> | PSE parameter fault. | <ul style="list-style-type: none"> Check parameter PSE and select correct setting corresponding to the type of PSE Softstarter. See chapter 7.7.2. |
| Shunt fault Red Fault LED steady lighting, and LCD event code SF3x 1. See chapter 6.1.2.1 about LED status indicators activation for faults and protections. | By-pass relays closed after transport, (PSE18...PSE170 only). | <ul style="list-style-type: none"> Switch off operational voltage and control supply voltage. Switch on voltage in correct succession. <ol style="list-style-type: none"> Control supply voltage on terminals 1 and 2. See chapter 5.2.4. Wait 4 seconds, and then switching on operational voltage on terminals L1, L2 and L3. See chapter 5.2.3. |
|  <p>The LCD display shows the fault code SF34. Above the display are indicators for Ready, Run, Protection, and Fault. Below the display are indicators for 10, E.O.L., and FBP.</p> | The by-pass contactor's/relays are not opening. | <ul style="list-style-type: none"> Check and replace relay. Contact your ABB Sales Office for replacement kit. |
| | Thyristors short circuit. | <ul style="list-style-type: none"> Check and replace thyristor. Contact your ABB Sales Office for replacement kit. |
| By-pass open Red Fault LED steady lighting, and LCD event code SF4x 1. See chapter 6.1.2.1 about LED status indicators activation for faults and protections. | Power loss on control supply circuit. | <ul style="list-style-type: none"> Check control supply voltage |
| | By-pass relays/contactor's open or by-pass relays/contactor's do not close. | <ul style="list-style-type: none"> Check and replace by-pass relay/contactor. Contact your ABB Sales Office for replacement kit. |
|  <p>The LCD display shows the fault code SF44. Above the display are indicators for Ready, Run, Protection, and Fault. Below the display are indicators for 10, E.O.L., and FBP.</p> | | |
| Softstarter thermal overload Red Fault LED steady lighting, and LCD event code SF50. See chapter 6.1.2.1 about LED status indicators activation for faults and protections. | Thyristors overheated. If the fault remains after reset, the heat sink temperature is too high. | <ul style="list-style-type: none"> Check that the fans are working in a proper way. See chapter 9.1. Check that the cooling airways are free from dirt and dust. See chapter 9.1. Check that the ambient temperature is not too high. Derating is required above 40°C (104 °F). See chapter 3.6. Check that the mounting angle is not more than 30°. See chapter 4.2.4. Check that PSE Softstarter not is too small for the number of starts and stops performed each hour. |
|  <p>The LCD display shows the fault code SF50. Above the display are indicators for Ready, Run, Protection, and Fault. Below the display are indicators for 10, E.O.L., and FBP.</p> | | |

SF = Softstarter fault

EF = External fault

P = Protection

1 x = phase number, 4 indicates multiple or unknown phase

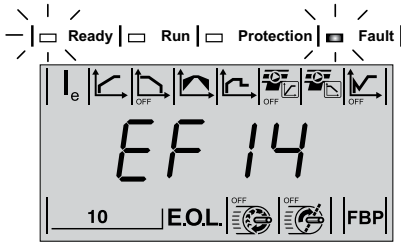
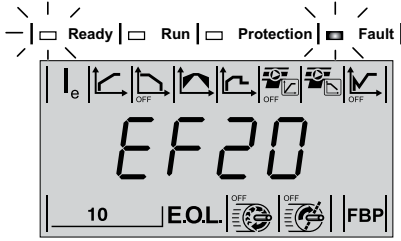
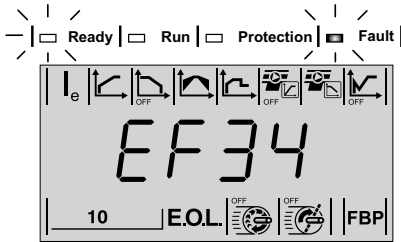

| Status | Possible cause | Solution |
|--|--|---|
| <p>Phase loss fault Red Fault LED steady lighting, and LCD event code EF1x ❶. See chapter 6.1.2.1 about LED status indicators activation for faults and protections.</p>  <p>1SFC132318F0001</p> | <p>Fuse blown.</p> <p>Power loss on operational current on one or several phases.</p> <p>The main contactor or circuit breaker is open.</p> <p>Main contactor opens too quickly at stop.</p> | <ul style="list-style-type: none"> • Check and replace fuses in all three phases. • Check and correct supplying operational network. • Check and close contactor/breaker or any external switching device. • Control main contactor with Run signal relay on terminal 4. See chapter 5.2.4.6. • Add a time relay before contactor opening. • If Stop Ramp not is needed, set Stop Ramp Time to 0. |
| <p>Bad network quality Red Fault LED steady lighting, and LCD event code EF20. See chapter 6.1.2.1 about LED status indicators activation for faults and protections.</p>  <p>1SFC132311F0001</p> | <p>Excessive disturbances in the operational supplying network.</p> <p>Short power loss on all three phases in the operational network.</p> | <ul style="list-style-type: none"> • Check and correct supplying operational network. • Check and correct supplying operational network. |
| <p>Current lost fault Red Fault LED steady lighting, and LCD event code EF3x ❶. See chapter 6.1.2.1 about LED status indicators activation for faults and protections.</p>  <p>1SFC132310F0001</p> | <p>Operational current too low or lost on one or several phases.</p> <p>Phase loss on line side or motor side.</p> <p>Thyristors not able to conduct</p> <p>The motor is too small. (current is out of measuring range).</p> | <ul style="list-style-type: none"> • Check and correct supplying network • Check and correct supplying network • See Phase loss EF14. • Check and replace PCB/thyristor. Contact your ABB Sales Office for replacement kit. • Check that the softstarter corresponds to the motor size. |

SF = Softstarter fault

EF = External fault

P = Protection

❶ x = phase number, 4 indicates multiple or unknown phase

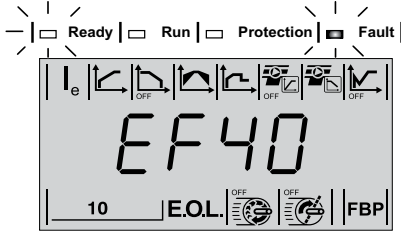
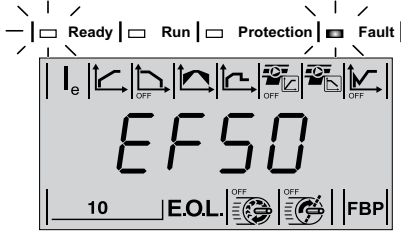
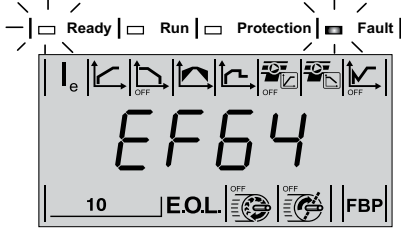

| Status | Possible cause | Solution |
|--|--|---|
| <p>Fieldbus fault Red Fault LED steady lighting, and LCD event code EF40. See chapter 6.1.2.1 about LED status indicators activation for faults and protections.</p>  <p>1SFC132313F0001</p> | <p>Fault on fieldbus connection or Field-BusPlug Accessory.</p> <hr/> <p>Fieldbus communication is not working.</p> <hr/> <p>PLC is not running.</p> <hr/> <p>Fieldbus Control is enabled on a non-fieldbus application.</p> | <ul style="list-style-type: none"> • Check that the correct type of FieldBusPlug accessory is used. See Chapter 8 or contact your ABB Sales Office. • Check that the connection of the FieldBusPlug is correct. See chapter 3.2. • Check the connection of the fieldbus accessory. • Perform a reset on any active event. See chapter 6.1.5 Reset of tripping events. <hr/> <ul style="list-style-type: none"> • Check that the correct type of FieldBusPlug accessory is used. See Chapter 8 or contact your ABB Sales Office. • Check that the connection of the FieldBusPlug is correct. See chapter 3.2. • Check the connection of the fieldbus accessory. • Check PLC configuration. • Possible Fieldbus fault. <hr/> <ul style="list-style-type: none"> • Put PLC in run mode. • Check PLC configuration. <hr/> <ul style="list-style-type: none"> • Set Fieldbus Control parameter to OFF. |
| <p>Low supply voltage Red Fault LED steady lighting, and LCD event code EF50. See chapter 6.1.2.1 about LED status indicators activation for faults and protections.</p>  <p>1SFC132314F0001</p> | <p>The control supply voltage is too low on terminals 1 and 2.</p> <hr/> <p>Short power loss on the control supply network.</p> | <ul style="list-style-type: none"> • Check and correct control supply voltage. • Check control supply network for short interruptions. |
| <p>High current fault Red Fault LED steady lighting, and LCD event code EF6x ①. See chapter 6.1.2.1 about LED status indicators activation for faults and protections.</p>  <p>1SFC132315F0001</p> | <p>Operational current higher than $8 \times I_e$.</p> | <ul style="list-style-type: none"> • Check if the motor is locked or running stiff. • Check the bearings in the motor and connected equipment. • Check if the load on the motor is too heavy. • Check isolation on the motor windings. • Replace the motor. |

SF = Softstarter fault
EF = External fault
P = Protection

① x = phase number, 4 indicates multiple or unknown phase

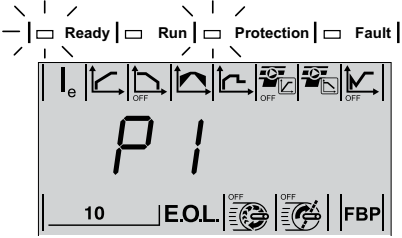
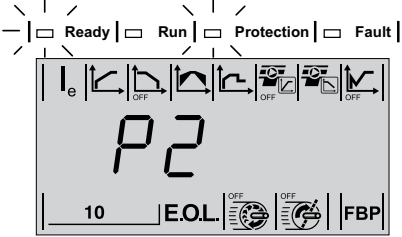
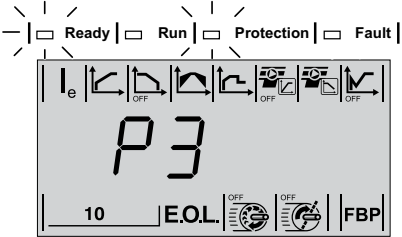
| Status | Possible cause | Solution |
|--|--|--|
| <p>Motor Overload Protection (EOL) Red Fault LED steady lighting, and LCD event code P1. See chapter 6.1.2.1 about LED status indicators activation for faults and protections. Remark that time delay for reset can be long depending on temperature.</p>  <p>1SFC132320F0001</p> | <p>Load on motor higher than motor rating and corresponding selected EOL Class.</p> <p>Too many starts and stops during a short time.</p> <p>The motor has been exposed to an overload condition because the current over a certain time is too high. (The load on the motor shaft is too high).</p> | <p>At start</p> <ul style="list-style-type: none"> • Check and correct the reason for the overload. • Increase Initial/End Voltage. • Check the motor rating plate for I_e. • Increase Current Limit. • Make Start Ramp Time shorter. <p>At start</p> <ul style="list-style-type: none"> • Chose a motor with more power, and a softstarter rated for higher current. • Check and correct the reason for the overload. • Check that the ramp time for start not is too long. • Check that correct EOL Class is used. <p>Continuous run</p> <ul style="list-style-type: none"> • Check the rating of the plate for I_e. • Check operational voltage. • Chose a motor with more power, and a softstarter rated for higher current. • Check and correct the reason for the overload. • Check that correct EOL Class is used. |
| <p>Underload Protection Red Fault LED steady lighting, and LCD event code P2. See chapter 6.1.2.1 about LED status indicators activation for faults and protections.</p>  <p>1SFC132316F0001</p> | <p>The motor current is below set level and time.</p> | <ul style="list-style-type: none"> • Check and correct the reason for the underload. • Check that the setting I_e are according to the operation conditions. See chapter 7.5.1. • Check that the Underload Protection parameter is set according to operational conditions. See chapter 7.5.10. |
| <p>Locked Rotor Protection Red Fault LED steady lighting, and LCD event code P3. See chapter 6.1.2.1 about LED status indicators activation for faults and protections.</p>  <p>1SFC132322F0001</p> | <p>The motor is running stiff for some reason. A damaged bearing or a stuck load could be possible causes.</p> <p>Decrease in operational voltage can give a higher operational current.</p> | <ul style="list-style-type: none"> • Check the bearings of the motor and load. • Check voltage. |

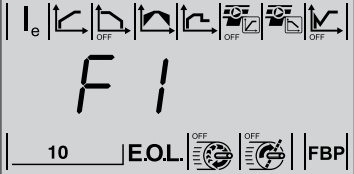
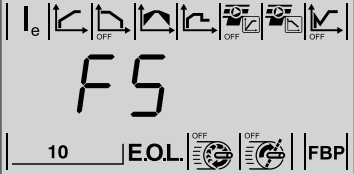
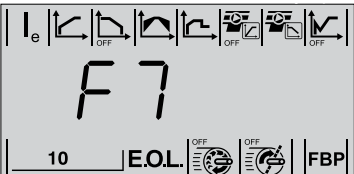
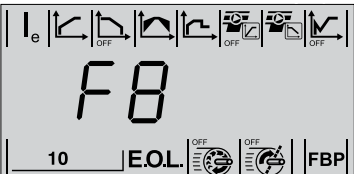

| Status | Possible cause | Solution |
|---|--|---|
| <p>Transfer of parameters failed Only showing on external keypad. Can occur for transfer both from the PSE and to the PSE. Same failure for F1, F2, F3, F4 and F6.</p> | <p>Fault in software.</p> | <ul style="list-style-type: none"> • Try again. • If the same failure remains, contact your local ABB Sales Office. |
| <p> <input type="checkbox"/> Ready <input type="checkbox"/> Run <input type="checkbox"/> Protection <input type="checkbox"/> Fault </p>  <p>The keypad display shows the fault code 'F1' in the center. Above the display are several icons representing different system states and functions, some with 'OFF' labels. Below the display, there are indicators for '10', 'E.O.L.', and 'FBP'.</p> | | |
| <p>Transfer of parameters failed Only showing on external keypad. Can occur for transfer to the PSE.</p> | <p>No parameters stored in the PSEEK.</p> | <ul style="list-style-type: none"> • Load the parameters that you want to transfer from selected PSE. • If the same failure remains, contact your local ABB Sales Office. |
| <p> <input type="checkbox"/> Ready <input type="checkbox"/> Run <input type="checkbox"/> Protection <input type="checkbox"/> Fault </p>  <p>The keypad display shows the fault code 'F5' in the center. Above the display are several icons representing different system states and functions, some with 'OFF' labels. Below the display, there are indicators for '10', 'E.O.L.', and 'FBP'.</p> | | |
| <p>All parameters was not transferred Only showing on external keypad. Can occur for transfer both from the PSE and to the PSE.</p> | <p>Fault in software.</p> | <ul style="list-style-type: none"> • Try again. • If the same failure remains, contact your local ABB Sales Office. |
| <p> <input type="checkbox"/> Ready <input type="checkbox"/> Run <input type="checkbox"/> Protection <input type="checkbox"/> Fault </p>  <p>The keypad display shows the fault code 'F7' in the center. Above the display are several icons representing different system states and functions, some with 'OFF' labels. Below the display, there are indicators for '10', 'E.O.L.', and 'FBP'.</p> | | |
| <p>Transfer of parameters failed Only showing on external keypad. Can occur for transfer to the PSE.</p> | <p>Not possible to transfer parameters to PSE when it is in TOR.</p> | <ul style="list-style-type: none"> • Return the PSE to idle state and try again • If the same failure remains, contact your local ABB Sales Office. |
| <p> <input type="checkbox"/> Ready <input type="checkbox"/> Run <input type="checkbox"/> Protection <input type="checkbox"/> Fault </p>  <p>The keypad display shows the fault code 'F8' in the center. Above the display are several icons representing different system states and functions, some with 'OFF' labels. Below the display, there are indicators for '10', 'E.O.L.', and 'FBP'.</p> | | |

Common Diagnostic Issues

Listed below are common issues that may occur while operating a Mathews Company grain dryer.

Problem:

Dryer will not reach operating temperature, or it reaches it slowly.

Possible Cause/Solution:

1. Low gas pressure. Increases gas pressure on the main gas regulatory.
2. Check for water in the gas train by opening the drain valve.
3. Make sure the dryer is completely full of grain by entering the heat plenum chamber and looking for daylight in one of the grain columns.
4. Make sure that the gas butterfly valve is being driven wide open by the modutrol motor. If not, check the motor or motor linkage. Also check to make sure that there is not a block within the gas piping. There should be 10 pounds on the primary regulator and 1 to 2 pounds on the secondary.
5. Ensure the max % valve opening on the Pinnacle 20|20 Control is not set too low.

Problem:

Blower motor(s) will not start.

Possible Cause/Solution:

1. Check that the fan circuit breaker and the fan switch are on. Also, check for a defective switch or bad wire connections.
2. Verify closing of the fan motor contactor. Check voltage on the load side of the contactor.
3. Inspect the contactor for defective contact or a burned out coil.
4. Inspect connections, and check voltage applied to the motor leads to determine if the motor is defective.

If the motor starts slowly, check for low voltage during starting due to excessive voltage drop in power supply wiring.

Problem:

Burner will not fire.

Possible Cause/Solution:

1. Check gas supply for possible obstruction or closed valves. Refill tank; replace or repair parts as required.
2. Inspect gas solenoid valves for defective coils or improper wiring. Replace the valve or coil if the valve will not open with proper voltage applied (115 volts).
3. Ensure initial % valve opening is properly set.



Problem:

Burner will not fire, but gauge shows gas pressure.

Possible Cause/Solution:

1. Check that the igniter is properly gapped and has a strong spark.
2. Inspect the porcelain and electrodes for damage or cracking. Clean or replace if necessary.
3. Machine does not have chassis ground.
4. Check solenoids for proper operation.
5. Ensure initial % valve opening is properly set.

Problem:

Uneven drying, some kernels appear brown while others are under dried. Uneven heat exiting from dryer columns.

Possible Cause/Solution:

1. Check plenum temperature setting. Some varieties of grain are more sensitive to higher operating temperatures. It may be necessary to lower the plenum operating temperature to accommodate this.

Problem:

Grain is not moving through columns.

Possible Cause/Solution:

1. Check the dryer for fine material buildup inside the columns.
2. Avoid leaving the dryer columns full for long periods at a time (2-3 days) while not operating the dryer, or during rainy weather.
3. Empty the dryer and clean regularly. Do not allow fine material to gather in the plenum chamber.

Problem:

Difficult lighting the burner

Possible Cause/Solution:

1. Fan must be ON to achieve air pressure light.
2. Ignition switch set to the ON position. This applies 120 VAC at L1 (0 volts at L2 Neutral) of the ignition board.
3. After pre-purge time, the ignition board should power out 120 VAC at V1 (V2 neutral) for a trial ignition period to eliminate the gas valve light and gas valve light. The ignition trial time is 7 seconds. If the trial is not successful, voltage outputs stop.
4. Check the gas solenoid operation by listening for a click/snap or feeling the vibration as they open. If the solenoid doesn't open, check the wiring and coil for damage, bad connections, etc.
5. Check the spark plug (igniter) for spark. Check the high voltage wire for damage, good connections.
6. Replace the ignition board.
7. Ensure initial % valve opening is properly set.



Problem:

The burner lights but does not stay on.

Possible Cause/Solution:

(NOTE: This is most likely due to the flame sensing)

1. Ensure flame sense probe is located in the flame.
2. Inspect the sense wire for damage and for loose or wet connections.
3. Check that sense wire is routed separately from the high voltage ignition wire.
4. Check the ignition board (B.GND) is grounded separately from all other connections. Sharing a ground connection can cause problems.
5. Clean sense probe with fine steel wool.

Burner may have to be grounded at the burner body directly to the burner housing



