

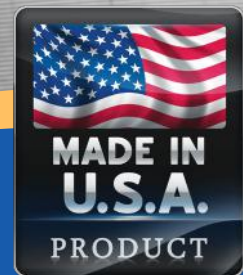

NEXT GENERATION  
**LEGACY** SERIES

# OPERATIONS MANUAL

Effective May 2023



# GRAIN DRYER SPECIALISTS

DOC-L01-0523

# OPERATIONS MANUAL - LEGACY SERIES



© 2023 Mathews Company  
500 Industrial Avenue  
Crystal Lake, IL 60012 USA  
[www.mathewscompany.com](http://www.mathewscompany.com)

# CSA 3.8 2014 Certified Dryers



The following instructions pertain to dryers built and certified to the CSA 3.8 2014 standard and is meant for qualified personnel only.

## Gas Installation

The equipment shall be installed in accordance with the Natural Gas and Propane Installation Code, CSA B149.1 and the Propane Storage and Handling Code, CSA B149.2, or applicable provincial regulations, which should be carefully followed in all cases. Authorities having jurisdiction should be consulted before installations are made.

## Installation of Fuel Piping

### LP

LP installations shall conform to the following:

- The LP supplier must install the appropriate supply line in Type K copper underground from the supply tank to the edge of the concrete pad as per B149.1,2. This is solely the responsibility of the fuel supplier under the Z code.
- If an underground installation is not preferred, a continuous run of black iron and copper can be installed above the concrete.
- A continuous piece of type K copper can be used through or under the concrete provided that it is protected by sleeves or in a channel. A coil at the final connection can be used as an expansion provided it is not kinked.
- A typical installation on LPG starts with the Type K copper ending at the pad followed by a swing joint attached to lengths of SK80 piping fittings with resign coated hanger brackets attached to the concrete to avoid galvanic reaction. The final connection shall have a swing joint or category 1 expansion hose no longer than 3 feet in length followed by a SK 80 union to facilitate removal and final attachment to ball valve supplied by manufacturer.

Pertinent code clauses pertaining to basic installation:

- B149.1 6.16.3 piping and tubing shall be mounted and braced to provide for vibration, contraction or jarring.
- B149.1 6.14.1 a defective section of piping or tubing shall be replaced
- B149.1 6.14.5 piping shall not be field bent
- B149.1 6.9.6 joint sealant shall conform to Can/ulc 642 and shall be applied to male threads of the pipe
- B149.1 6.8.1 piping ends shall be free of cuttings and burs
- B149.1 6.8.2 piping shall be reamed
- B149.1 6.14.2 bushings shall not be nested
- B149.1 6.11.9 provide effective swing joints at manifolds to accommodate for expansion and contraction and ground level and at appliance level
- B149.1 6.20.5 metallic gas hose can be used in commercial or industrial environments where vibrations, expansions or contractions are present.
- B149.1 6.20.3 gas hose for a PERMANENT installation shall not exceed 10 feet in length a permanent installation consists of an appliance hard wired to the electrical source a generator or PTO is considered temporary and can be moved.
- B149.1 6.16.1 piping exposed to atmospheres shall be painted or coated
- B149.1 6.17.1 standard practice paint Liquid propane piping RED.
- B149.1 union should be installed to facilitate removal of piping if required.

- B149.1 6.2.2 a fitting used shall with steel shall be malleable iron or steel
- B149.1 hydrostatic relief devices shall be used where liquid propane can be trapped and vented to a safe location
- B149.1 6.4.3 schedule 80 piping and fittings shall be used on liquid phase systems or over 125 psi
- B149.1 6.16.6 when piping or tubing is run in a sleeve the sleeve shall be of a type of material that will avoid galvanic reaction and protect the tubing
- B149.1 6.15.10 when tubing is laid under pavement and re-enters above ground a sleeve shall be used to protect the tubing through the concrete.
- B149.1 6.2.15 plastic pipe shall not be used in a liquid piping system
- B149.1 6.4.17 close nipples, street elbow or street T shall not be used
- B149.1 6.2.5 flare nuts shall not be externally forged or machined and shall be of the forged type
- B149.1 6.2.4 copper shall be of the type K,G or L
- B149.1 6.9.9 a joint in seamless copper shall be of a flared type

## NG

NG installations shall conform to the following:

- Typically a gas meter is installed 15 feet away from the grain dryer. A pipe can be extended with a union to the pavement level with a swing joint before attaching to the pavement as the meter can move independently from the concrete pad. This can then be followed by a length of pipe to an additional swing joint, or type 2 gas hose, acting as a swing joint attached to the final connection with a union. There shall be a shut off valve after the union.

Pertinent code clauses pertaining to basic installation:

- B149.1 6.4.17 close nipples, street elbow or street T shall not be used
- B149.1 union should be installed to facilitate removal of piping if required.
- B149.1 6.2.2 a fitting used shall with steel shall be malleable iron or steel
- B149.1 6.20.3 gas hose for a PERMANENT installation shall not exceed 10 feet in length a permanent installation consists of an appliance hard wired to the electrical source a generator or PTO is considered temporary and can be moved.
- B149.1 6.16.1 piping exposed to atmospheres shall be painted or coated yellow
- B149.1 6.16.3 piping and tubing shall be mounted and braced to provide for vibration, contraction or jarring.
- B149.1 6.14.1 a defective section of piping or tubing shall be replaced
- B149.1 6.14.5 piping shall not be field bent
- B149.1 6.9.6 joint sealant shall conform to Can/ulc 642 and shall be applied to male threads of the pipe
- B149.1 6.8.1 piping ends shall be free of cuttings and burs
- B149.1 6.8.2 piping shall be reamed
- B149.1 6.14.2 Bushings shall not be nested
- B149.1 6.11.9 provide effective swing joints at manifolds to accommodate for expansion and contraction and ground level and at appliance level
- B149.1 6.20.5 metallic gas hose can be used in commercial or industrial environments where vibrations, expansions or contractions are present.
- B149.1 6.20.3 gas hose for a PERMANENT installation shall not exceed 10 feet in length a permanent installation consists of an appliance hard wired to the electrical source a generator or PTO is considered temporary and can be moved.
- B149.1 6.4.3 schedule 40 piping and fittings shall be used on systems or under 125 psi

## Field Installed Wiring

Dryer wiring from the branch circuit is included in the field installation wiring schematic. All wiring is to be in accordance with the Canadian Electrical Code, Part1, CSA C22.1

This dryer is not service rated, and will require an additional overload protection device in front of the dryer for adequate protection. All wiring is to be in accordance with the Canadian Electrical Code, Part1, CSA C22.1.

The electrical installation should follow domestic NEC standards.

Minimum wire size is 18awg unless specified.

All wire gauges shown on the drawing are recommended only! Electrical contractor should follow the local codes and authority having jurisdiction.

All wire sizing based on copper conductors, but aluminum may be used if sized correctly.

This dryer is not service rated. Proper service protection is recommended.

## Pressure Testing

The dryer and its individual shutoff valve must be disconnected from the gas supply piping system during any pressure testing of that system at test pressures in excess of 1/2 psi (3.5 kPa). The dryer must be isolated from the gas supply piping system by closing its individual manual shutoff valve during any pressure testing of the gas supply piping system at test pressures equal to or less than 1/2 psi (3.5 kPa)

### Min/Max Gas Supply Pressures

Refer to the dryer rating plate for determining the minimum gas supply pressure for obtaining the maximum gas capacity for which this dryer is specified.

## Leak Tests

Gas leak tests need to be performed during dryer start-up to verify the gas-tightness of the dryer's components and piping under normal operating conditions. During the tests, observations should be made at the gauges attached to the unit. If the gauges are reading 0, there could be a leak as the system is normally under pressure. A soapy water solution can be used to check fittings for leaks while the unit is in operation by a 60/40 mixture of soap and water with a brush. Gauges can be installed before and after the safety shutoff valves. The unit can be bumped and shut off. If the gauges return to 0, a leak could be present.

## Gas Tightness Check

Safety shut off valves need to be tested for tightness annually. To test, inlet connections should be soap tested up to the safety shut-off valves or solenoid. From there, install gauges in between the safety shut-off valves or solenoids. Fire up the dryer with the firing valve closed. The firing valve is the valve located just before the burner. The safety shut-off valves will open, pressurizing the system and allowing the gauges to read pressure. The dryer will fail on ignition and the gauges should remain pressurized. If the gauges drop in pressure with the firing valve closed, that would indicate a potential leak. If the gauges return to 0 soap testing should commence on all fittings.

## Venting

The following specifications need to be followed in regards to venting:

- B149.1 5.4.1 hydrostats must be vented to a “safe location”
- B149.1 5.4.2 hydrostats may be vented into a common header provided the cross sectional area is equal to the cross sectional area of the multiple vents IE: 2 /12 “ hydrostats must vent into a 1” line
- B149.1 5.5.6 vents must be designed not to allow water, insects or debris simply put use a drip and a 90 at the end of the pipe with a screen
- B149.1 5.5.9 vents shall terminate 10 feet from mechanical air intake
- B149.1 5.5.8 vents shall not be capped off or made in-operable
- B149.1 5.5.4 vents shall not be reduced in size as to impede on the performance.

## Emergency Manual Shut-off Valve

The gas piping installer must install a manual emergency shutoff valve in an appropriate location that allows access to this valve to shut off the fuel to the dryer in case of a fire or explosion at the dryer. This installation must conform to the following:

- B149.1 6.18.2 a readily accessible manual shutoff valve must be installed as per below. Either one is acceptable.
- In the drop or rise, as close as possible to the valve train of a commercial or industrial valve train.
- In the horizontal piping of the drop or riser and the appliance valve train within 2 feet of the appliance.

## Warning

If the information in the operations manual is not followed exactly, a fire or explosion may result causing property damage, personal injury or loss of life.

Do not store or use gasoline or other flammable vapors and liquids in the vicinity of this or any other appliance.

## What To Do If You Smell Gas

- Do not try to light any appliance
- Extinguish any open flames
- Do not touch any electrical switch
- Immediately call your gas supplier. Follow the gas supplier’s instructions
- If you cannot reach your gas supplier, call the fire department.
- Installation and service must be performed by a qualified installer, service agency or the gas supplier
- Improper installations, adjustment, alteration, service or maintenance can cause property damage, injury or death. Read the installation, operating, and maintenance instructions thoroughly before installing or servicing this equipment.

## For Your Safety

The use and storage of gasoline and other flammable vapors and liquids in open containers in the vicinity of this appliance is hazardous. Refer to codes and standards CSA 3.8, 4.29.7

# Warranty Statement

---

## MATHEWS COMPANY LIMITED WARRANTY FOR WHOLE GOODS





Except as otherwise set forth herein, Mathews Company (Seller) warrants that the equipment supplied by Seller to Buyer shall be free from defects in materials and workmanship when properly installed and operated under normal conditions and in accordance with all applicable instruction manuals. This limited warranty shall expire two (2) years from the date of shipment from Seller's Crystal Lake, Illinois, U.S.A. facility. In addition, for a period of five (5) years from the date of shipment from Seller's Crystal Lake, Illinois, U.S.A. facility, Seller will re-balance M-C Shredder rotors for Buyer at Seller's Crystal Lake, Illinois, U.S.A. facility, provided that the rotors did not become unbalanced through abnormal use by Buyer or were not damaged by Buyer in any way.

To obtain consideration under this limited warranty, Buyer must first notify Seller in Crystal Lake, Illinois, U.S.A., stating in what respects the equipment is believed by Buyer to be defective and providing a list of the parts at issue. Additionally, Buyer must complete a warranty request form stating the machine serial number. Upon receipt by Seller of such notice from Buyer, Buyer may receive authorization from Seller to return the parts. If parts are to be scrapped locally, Buyer will be so advised. If Seller provides Buyer with authorization to return the parts, Buyer shall return such parts to Seller's facility in Crystal Lake, Illinois, U.S.A., transportation prepaid, for examination by Seller. No parts shall be returned to Seller unless Buyer first obtains a return authorization number from Seller. If, in Seller's sole judgment, the parts returned by Buyer are defective and covered under this limited warranty, Seller shall have the option of repairing, rebuilding or replacing such parts. This limited warranty shall not apply to parts which, in Seller's sole judgment, have been the subject of negligence, abuse, accident, misapplication, tampering, alteration, improper adjustment, or electrical problems caused by low voltage conditions; nor shall it apply to consumables, such as belts; nor shall it apply to parts damaged by acts of God, war or civil insurrection, acts of terrorism, improper installation, operation, maintenance or storage, or other than normal application, use or service, including, without limitation, operational failures caused by corrosion, erosion, wear and tear, rust or other foreign materials in the system in which they are utilized.

Failure to give notice within the warranty period shall be a waiver of this limited warranty and no assistance or other action thereafter taken by Seller shall be deemed to extend or revive the warranty period. This limited warranty covers only whole goods and shall not apply to replacement parts or upgrade kits. A separate warranty statement published by Seller covers the warranty on parts and upgrade kits. This limited warranty shall not apply to any products, parts, accessories or other equipment not manufactured by Seller, provided that Seller, upon request by Buyer, shall advise Buyer of any warranties known to Seller that may be offered by the manufacturer of such equipment. This limited warranty shall not cover, and Seller shall not under any circumstances be liable for, damages for injuries to persons or property; loss of crops or other products; losses caused by harvest delays; loss of profits; loss of use; cost of rental equipment; expenses of labor, travel or other items relating to the removal or replacement of defective parts; damages resulting from the removal of defective parts or the installation of repaired, rebuilt or replaced parts; expenses relating to the transportation of parts to and from Seller's facility; any consequential, incidental, contingent or special damages, whether arising in contract, in tort or under statute; or any other damages or expenses not agreed upon in writing by Seller, even if Seller has been advised of the potential for any such damages or expenses.

THIS LIMITED WARRANTY IS IN LIEU OF ALL WARRANTIES, EXPRESS OR IMPLIED, INCLUDING, WITHOUT LIMITATION, ALL WARRANTIES OF MERCHANTABILITY AND FITNESS FOR A PARTICULAR PURPOSE OR USE. No person is authorized to give any other warranty or to assume any other liability on Seller's behalf.

# Table of Contents

	<b>Introduction.....</b>	<b>1.1</b>
	<b>Overview .....</b>	<b>1.1</b>
	<b>Grain Drying Principles.....</b>	<b>1.1</b>
	Air .....	1.1
	Heat .....	1.1
	Time.....	1.1
	<b>Owner / Operator Notes .....</b>	<b>1.2</b>
	<b>Warranty Registration .....</b>	<b>1.2</b>
	<b>Model / Serial Number / Specifications.....</b>	<b>1.2</b>
	<b>Safety .....</b>	<b>1.3</b>
	Lock-out / Tag-out Requirements .....	1.4
	Blocks.....	1.5
	<b>Specifications.....</b>	<b>2.1</b>
	Standard Specs .....	2.1
	Metric Specs .....	2.1
	L1000 Dimensions .....	2.2
	L1500 Dimensions .....	2.3
	L2000 Dimensions .....	2.4
	L3000 Dimensions .....	2.5
	L4000 Dimensions .....	2.6
	L5000 Dimensions .....	2.7
	<b>Equipment Overview.....</b>	<b>3.1</b>
	<b>Main Dryer Components .....</b>	<b>3.1</b>
	<b>High Voltage Cabinet.....</b>	<b>3.3</b>
	<b>Auxiliary High Voltage Cabinet .....</b>	<b>3.4</b>
	<b>Low Voltage Cabinet .....</b>	<b>3.5</b>
	<b>Pinnacle 20   20 Remote Cabinet .....</b>	<b>3.6</b>
	<b>Pinnacle 20   20 Customer Equipment Cabinet .....</b>	<b>3.7</b>
	<b>Burner Control Cabinet .....</b>	<b>3.8</b>
	<b>Discharge Moisture Sampler .....</b>	<b>3.10</b>
	<b>Gas Train .....</b>	<b>3.11</b>
	LPG Gas Train .....	3.11
	NG Gas Train .....	3.11
	LPG Gas Train (with Optional CSA Requirements) .....	3.12
	NG Gas Train (with Optional CSA Requirements) .....	3.12
	NG Gas Train (With Optional CE Requirements).....	3.13
	LPG Standpipe .....	3.14
	NG Standpipe.....	3.14
	LPG Standpipe (with Optional CSA Requirements).....	3.15
	NG Standpipe (with Optional CSA Requirements).....	3.15
	NG Standpipe (With Optional CE Requirements) .....	3.16
	<b>Burner .....</b>	<b>3.18</b>
	<b>Operating Procedures.....</b>	<b>4.1</b>
	<b>Overview .....</b>	<b>4.1</b>
	<b>Component Adjustments .....</b>	<b>4.1</b>
	Air Pressure Switch.....	4.1
	High Limit Switch .....	4.2
	Variable Frequency Drive (VFD).....	4.4
	Changing Variable Frequency Drive Parameters.....	4.5



<b>Operational Procedures .....</b>	<b>4.6</b>
First Time Start-Up.....	4.6
Daily Shut-Down .....	4.7
Daily Start-Up .....	4.8
End-of-Season Shut-Down .....	4.8
Suggested Plenum Temperatures .....	4.10
Suggested Discharge Rate.....	4.11



**Maintenance .....** **5.1**

<b>Overview .....</b>	<b>5.1</b>
<b>Pre-Season Checks .....</b>	<b>5.1</b>
Grain Fill & Discharge System .....	5.1
Belt Adjustment.....	5.1
Fans & Burners .....	5.2
<b>Lubrication.....</b>	<b>5.3</b>
Outer Screens .....	5.4
Inner Screens .....	5.4
<b>Post-Season Maintenance .....</b>	<b>5.4</b>



**Troubleshooting .....** **6.1**

<b>Diagnosing a Dryer Shutdown .....</b>	<b>6.1</b>
Safety Circuit Overview .....	6.1
<b>Safety Circuit Schematic .....</b>	<b>6.4</b>
Safety Circuit (Fault Control).....	6.4
Safety Circuit (Human Safety).....	6.5
<b>Customer Interface .....</b>	<b>6.6</b>
Customer Connections .....	6.6
<b>Variable Frequency Drive (VFD) .....</b>	<b>6.7</b>
Display Faults.....	6.7
Fault Code Description .....	6.7
<b>Common Diagnostic Issues.....</b>	<b>6.17</b>



**Notes .....** **7.1**





# Introduction

This volume of the manual is intended to provide you with an overview of the construction, operation and maintenance of your Mathews Company Legacy Series Grain Dryer. The information contained herein is divided into 6 sections which are: Introduction, Specifications, Equipment Overview, Operating Procedures, Maintenance and Troubleshooting.

## Overview

The majority of the information in this manual applies to all Legacy Series Grain Dryers, however it is important to understand that there are different configurations and options that may or may not be included on your particular machine. In most cases it is indicated where there is a feature that may not be configured on all machines with a note of "if equipped" or "optional".

## Grain Drying Principles

Understanding fundamental grain drying principles is an important element of the operation of your grain dryer. As such, the following is a brief overview of the grain drying process.

Grain drying is a mass transfer process consisting of the removal of water by evaporation from the grain. In its most simplest concept, drying consists of three main components, Air, Heat and Time:

### Air

Ambient air is supplied to a fan that is horizontally mounted on the exterior of the dryer which pushes it through a burner to raise its temperature, then forces it across the column of grain. The function of the heated air is to facilitate a heat and mass transfer process. As the heated air passes over the grain, the heat from the air is transferred to the grain thereby elevating the temperature of the grain (heat transfer). Similarly, as the grain is heated, the moisture of the grain will start to exit to its surroundings as the equilibrium moisture of the grain is reached. This leads to the transfer of moisture from the grain to the air (mass transfer).

### Heat

The accurate control of this heating process is what makes the equipment energy efficient. As the ambient conditions (temperature and relative humidity) change, as well as the desired plenum setpoint, the gas control system will respond to opening or closing to allow more or less fuel to flow to the burner.

### Time

The time element of grain drying refers to the time the grain is spent inside the dryer. The time that the grain is exposed to the heated air determines how much moisture is driven out of the grain. The longer the exposure, more moisture removal occurs. As such, the best method for controlling the amount of moisture removal in the grain is to increase or decrease the grain's retention time by increasing or decreasing the discharge metering speed. The slower the metering system operates, the longer the grain is exposed to the heated air and the moisture removal is increased. The faster the metering system operates, the shorter the grain is exposed to the heated air and the moisture removal is decreased. The easiest way to keep good



grain quality and accurate control is to keep heat and air consistent while varying only grain retention time, which has proven to be the most common and efficient way to dry grain.

## Owner / Operator Notes

Before operating your grain dryer, it is strongly encouraged that you read the contents of this Operations Manual as well as Volume 2 - Pinnacle 20|20 Controls Manual. It will be important for you to become familiar with the controls, adjustments and settings required to obtain efficient operation.

To keep your dryer operating at its peak efficiency, it should be cleaned, lubricated, belts tensioned, ignition system checked, and the fill/takeaway in good operating condition. Refer to the Maintenance Section to understand the required maintenance and suggested intervals. The Pre-Season check can be made when the dryer is empty. Any necessary repairs or adjustments should be completed so that the dryer will be ready to operate before your drying season begins.

## Warranty Registration

It is important to send in your warranty registration card as soon as your new grain dryer is delivered. Not only does the card validate your warranty, but it also assists Mathews Company in disseminating information particular to your dryer model.

## Model / Serial Number / Specifications

The model and serial number of your Mathews Company continuous flow grain dryer are stamped on plates located on the base of the dryer as shown:

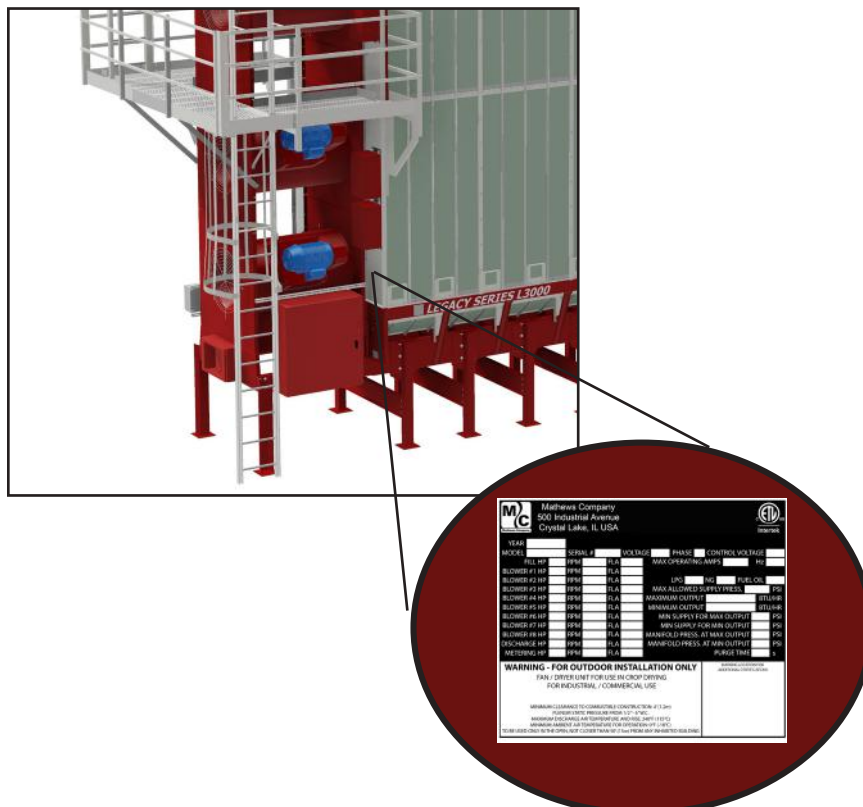

Specifications for the machine will be located on the nameplate which is located on the inside door of the High Voltage Cabinet as well as on the inside of the Remote Cabinet. A sample nameplate is shown below:

**Mathews Company**  
Means Commitment

**Technical Data Plate**  
Legacy Series

Model Number: L1500  
Serial Number: 2017\*\*\*  
Production Date: May 2017

Max Supply Pressure: 250 PSIG  
Max Manifold Pressure: 250 PSIG  
Max Fuel Rate: 12.7 MMBTU/hr  
Normal Fuel Rate: 9.6 MMBTU/hr

Fan #1 Motor Size / Speed: 20 HP / 1750 RPM  
Fan #2 Motor Size / Speed: 20 HP / 1750 RPM  
Fan #3 Motor Size / Speed: 30 HP / 1750 RPM  
Fan #4 Motor Size / Speed: N/A  
Fan #5 Motor Size / Speed: N/A  
Fan #6 Motor Size / Speed: N/A  
Fan #7 Motor Size / Speed: N/A  
Fan #8 Motor Size / Speed: N/A

Required Pressure for Max/Min Output: 1 PSIG / 0.5 PSIG  
Manifold Pressure at Max/Min Output: 3.5 PSIG / 0.5 PSIG

Max Plenum Static Pressure: 6" W.C.  
Fuel Type: LPG  
Control Voltage: 120/1/60  
Control Power Full Load Amps: 10 Amps  
Supply Voltage: 230/3/60  
Machine Full Load Amps: 229 A  
Short Circuit Current Rating: 10 kA

Discharge Motor Size / Speed: 1.5 HP / 1750 RPM  
Level Motor Size / Speed: 5 HP / 1750 RPM

**Mathews Company**  
500 Industrial Avenue  
Crystal Lake, IL 60012, U.S.A  
WARNING - For Outdoor Installation Only  
Industrial Control Panel For Industrial Machinery  
Electrical Control Panel Certified to UL 508A and CSA No.22.2 Codes and Standards  
This Dryer is NOT Electrical Service Rated

## Safety

While operating or performing maintenance on your machine, it is important to make safety a top priority. Be sure to read and understand the operations manual before attempting to operate the dryer. The following list of best practices should be followed to help ensure safe operation:

1. Keep ALL guards, access doors, covers, safety decals, and safety devices in place and securely fastened. Never operate the dryer while guards are removed.
2. Keep all untrained personnel away from system components and control panels at all times.
3. Never attempt to operate the unit by jumping or otherwise bypassing any safety devices.
4. Always open the main power supply disconnect switch and lock it in the open position with an approved lockout device prior to performing any service or maintenance work on the fan or burner unit.
5. Lock out power before removing guards, access doors, and covers.
6. Keep hands, feet and clothing away from all rotating parts.
7. Electrical repairs should be performed by trained and qualified personnel only. Failure to follow safe electrical procedures can result in serious injury.
8. If it should become necessary to perform checks on system components or high voltage test with energized circuits, proceed with extreme caution and follow all established safety practices.
9. Routinely check for any gas leaks.
10. Do not allow children or bystanders to be near the grain dryer or grain handling machinery while it is operating.
11. Do not operate the grain dryer without all safety shields in place and secure.



## Lock-out / Tag-out Requirements

The purpose of a lock-out / tag-out procedure is to prevent injury and/or death to personnel by requiring that certain precautions be taken before servicing or repairing equipment. This includes shutting off and locking-out the electrical power source of the equipment. A standard Lock-out / Tag-out program is explained as follows:

1. All maintenance personnel are issued a suitable lock (or locks) that is durable. The lock has the individual's name and other identification on it. Each worker must have his/her own lock and the only key to that lock. In addition, locks can be color coded to indicate different shifts or types of services.
2. Each person who will be working on the machinery should put a lock on the machine's lockout device(s). Each lock must remain on the machine until the work is completed. Only the individual who placed the lock should remove his/her lock.
3. Check to be sure that no one is operating the machinery before turning off the power. The machine operator must be informed before the power is turned off. Sudden loss of power could cause an accident.
4. Any mechanism under load or pressure, such as springs, should be released and blocked.
5. All energy sources that could activate the machine must be locked-out.
6. The main valve or main electrical disconnect must be tested to be sure that the power to the machine is off.
7. Electrical circuits must be checked by qualified persons with proper and calibrated electrical testing equipment. An electrical failure could energize the equipment, even if the switch is in the OFF position. Stored energy in electrical capacitors should be safely discharged.
8. Return disconnects and operating controls to the OFF position after each test.
9. Attach accident prevention tags. The tags will give the reason for placing the tag, the name of the person placing the tag, how he/she may be contacted, and the date and time the tag was placed.

The following are some images of lock out tag out material that can be used for locking out the work area:





### Blocks

Suitable blocks are another important safety device for making a piece of equipment safe to be repaired or serviced. Blocks must be placed under raised dies, lifts, or any equipment that might inadvertently move by sliding, falling, or rolling.

Blocks, special brackets, or special stands, such as those commonly used under raised vehicles, must be available at all times. Another form of blocking is the placement of a blind. A blind is a disk of metal placed in a pipe to ensure that no air or other substance will pass through that point if the system is accidentally activated.

Before installing blinds or blocks, bleed down steam, air or hydraulic lines to get rid of any pressure. Coiled springs, spring loaded devices or suspended loads must also be released so that their stored energy will not result in inadvertent movement.







# Specifications

## Standard Specs

Model	L1000	L1000VC	L1500	L1500VC	L2000	L2000VC	L3000	L4000	L5000	L6000
Holding Capacity (bu)	731	731	917	917	1,027	1,027	1,323	1,618	1,915	2,211
Grain Column Thickness	12"	12"	12"	12"	12"	12"	12"	12"	12"	12"
Grain Column Length	24' - 0"	24' - 0"	24' - 0"	24' - 0"	24' - 0"	24' - 0"	24' - 0"	24' - 0"	24' - 0"	24' - 0"
Burner Capacity (heat+cool) MMBTU/hr	4.39	4.39	7.01	7.01	8.97	8.97	10.74	15.13	19.52	23.91
Burner Capacity (all heat) MMBTU/hr	6.36	NA	9.62	NA	11.59	NA	15.98	20.37	24.75	29.14
Number of Fans	2	2	3	3	4	4	5	6	7	8
Total Fan Motor Size (HP)	45	45	70	70	85	85	115	145	175	205
Level Auger Motor Size (HP)	5	5	5	5	5	5	10	10	10	10
Unload Auger Motor Size (HP)	1.5	1.5	1.5	1.5	1.5	1.5	3	3	3	3
Electrical Load (208V/3ph/60Hz)	160	160	244	244	288	288	379	456	534	612
Electrical Load (230V/3ph/60Hz)	146	146	222	222	262	262	344	414	484	554
Electrical Load (460V/3ph/60Hz)	72	72	110	110	129	129	170	206	241	276

## Metric Specs

Model	L1000	L1000VC	L1500	L1500VC	L2000	L2000VC	L3000	L4000	L5000	L6000
Holding Capacity (m3)	17.0	17.0	21.4	21.4	23.9	23.9	30.8	37.7	44.6	51.5
Grain Column Thickness (cm)	30.5	30.5	30.5	30.5	30.5	30.5	30.5	30.5	30.5	30.5
Grain Column Length (m)	7.3	7.3	7.3	7.3	7.3	7.3	7.3	7.3	7.3	7.3
Burner Capacity (heat+cool) kW thermal	1287	1287	2055	2055	2629	2629	3148	4435	5721	7008
Burner Capacity (all heat) kW thermal	1864	NA	2820	NA	3397	NA	4684	5970	7254	8541
Number of Fans	2	2	3	3	4	4	5	6	7	8
Total Fan Motor Size (kW)	33.6	33.6	52.5	52.5	63.4	63.4	85.8	108.8	131.1	153.8
Level Auger Motor Size (kW)	3.7	3.7	3.7	3.7	3.7	3.7	7.5	7.5	7.5	7.5
Unload Auger Motor Size (kW)	1.1	1.1	1.1	1.1	1.1	1.1	2.3	2.3	2.3	2.3
Electrical Load (380V/3ph/50Hz)	86	86	132	132	156	156	205	248	290	332

# L1000 Dimensions

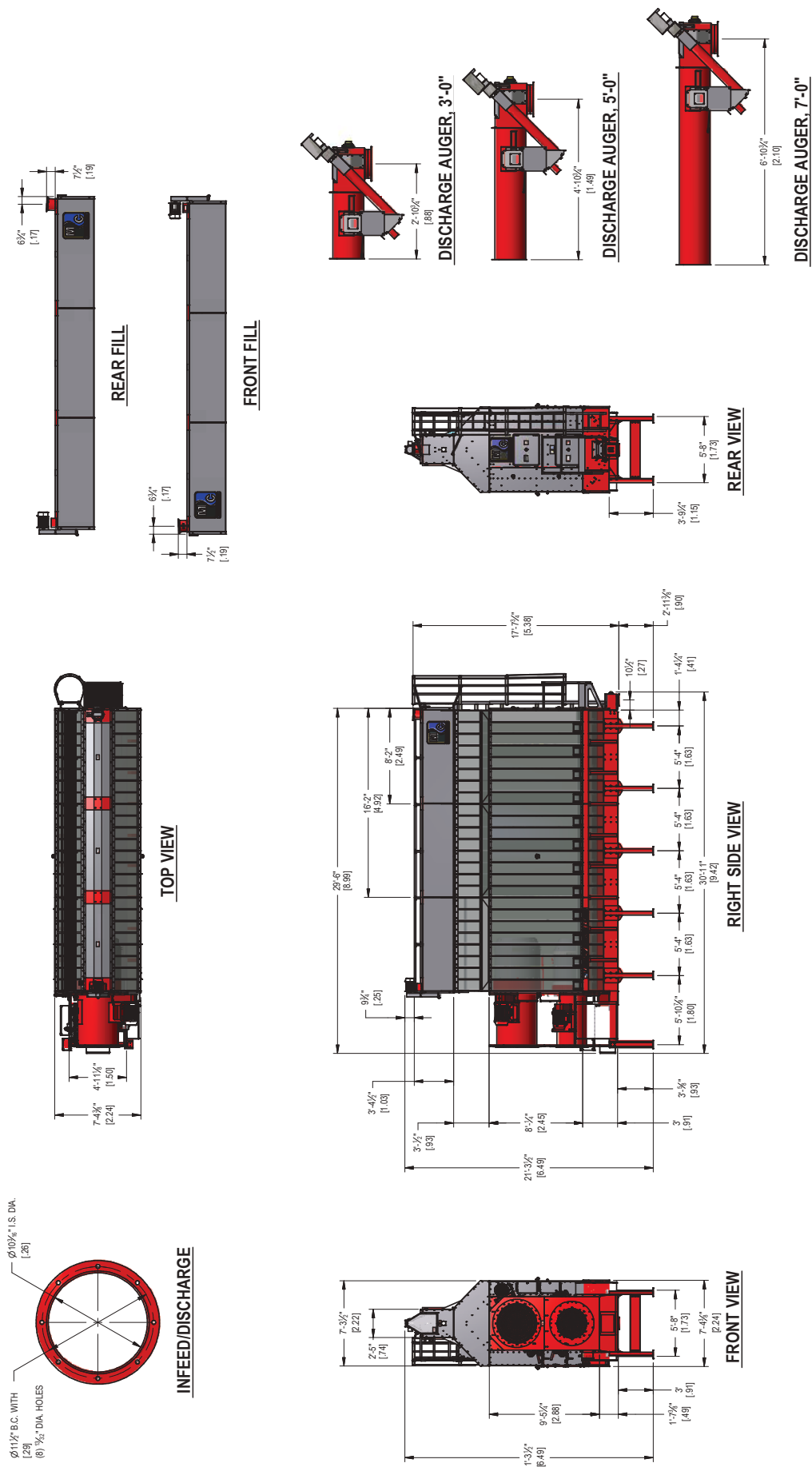







# L4000 Dimensions

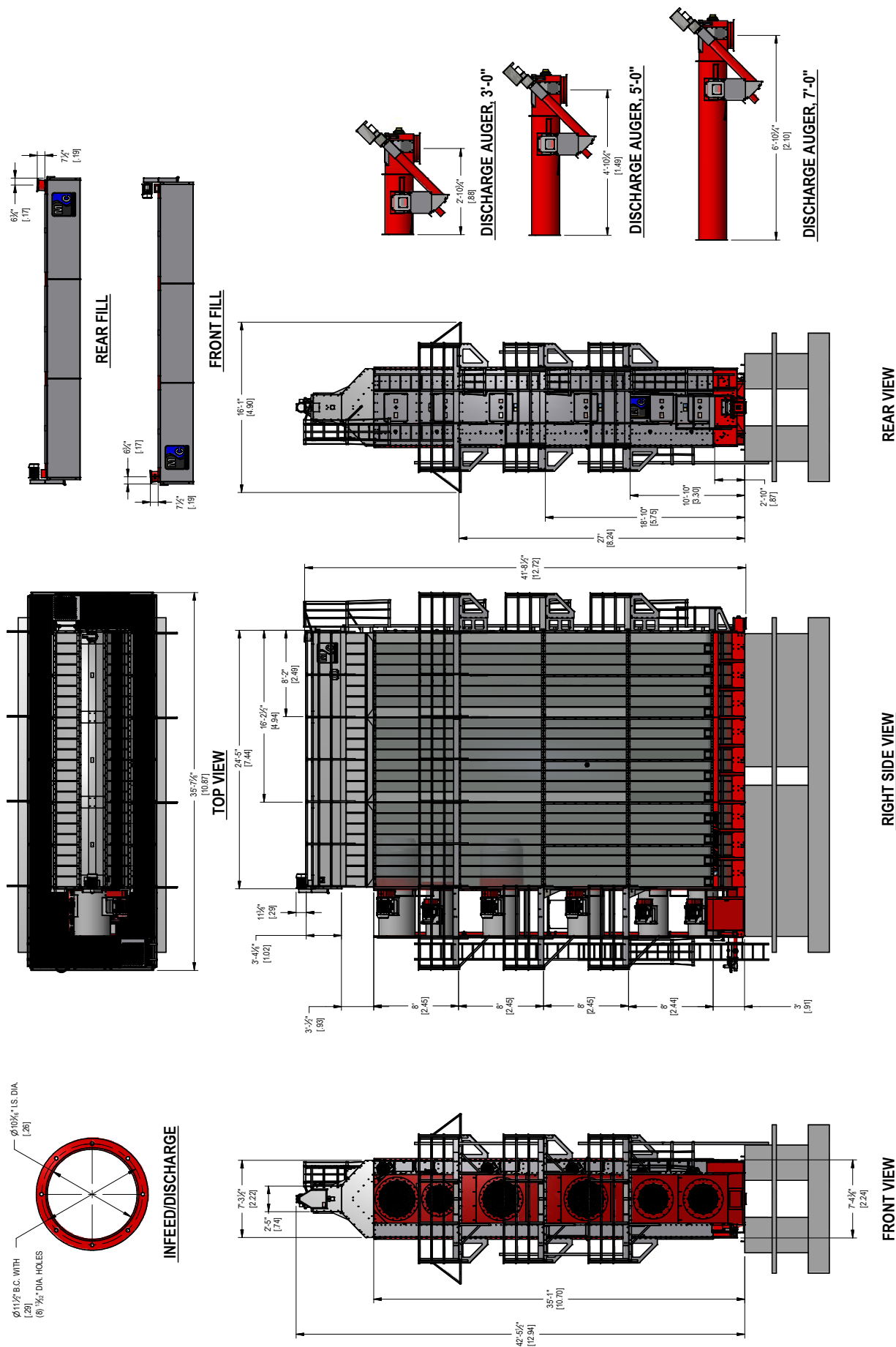

# L5000 Dimensions

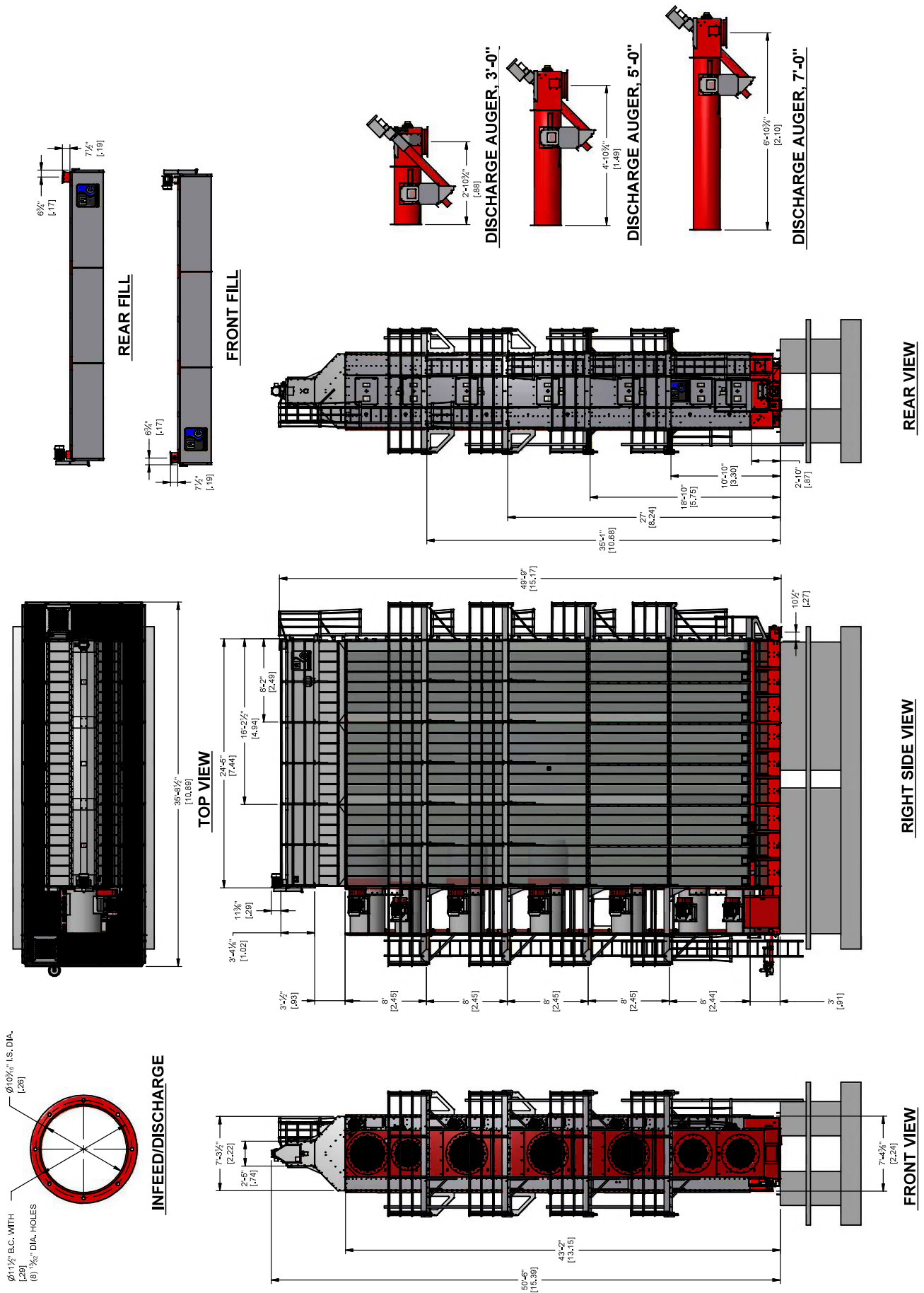



# L6000 Dimensions

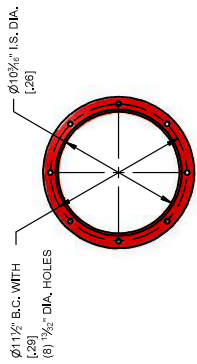

**INFED/DISCHARGE**

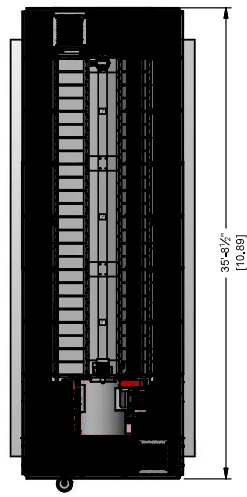

**TOP VIEW**

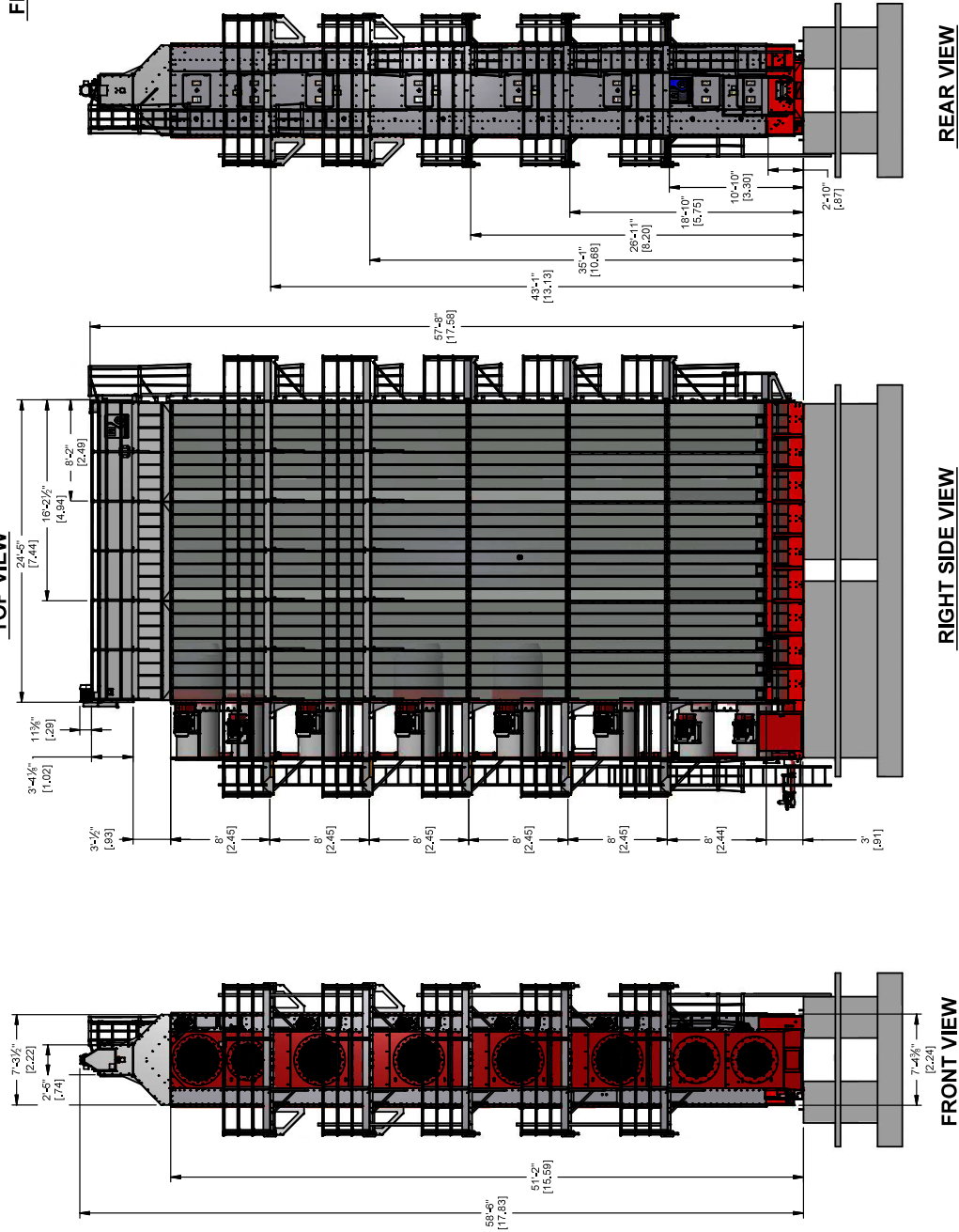
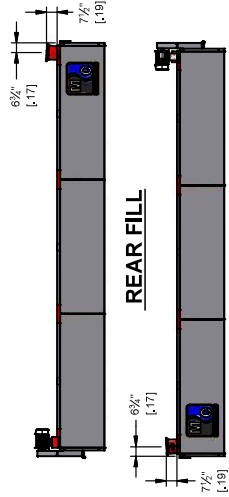

# Equipment Overview

The Equipment Overview section will help identify parts of the dryer and briefly explain their function. The images will physically show you what the component(s) look like and the description following will state their purpose.

## Main Dryer Components

The following rendered image shows an overall view of the dryer with some of the main components highlighted. The pages following will explain these components or assemblies more in depth as well as explain the function of any associated parts.

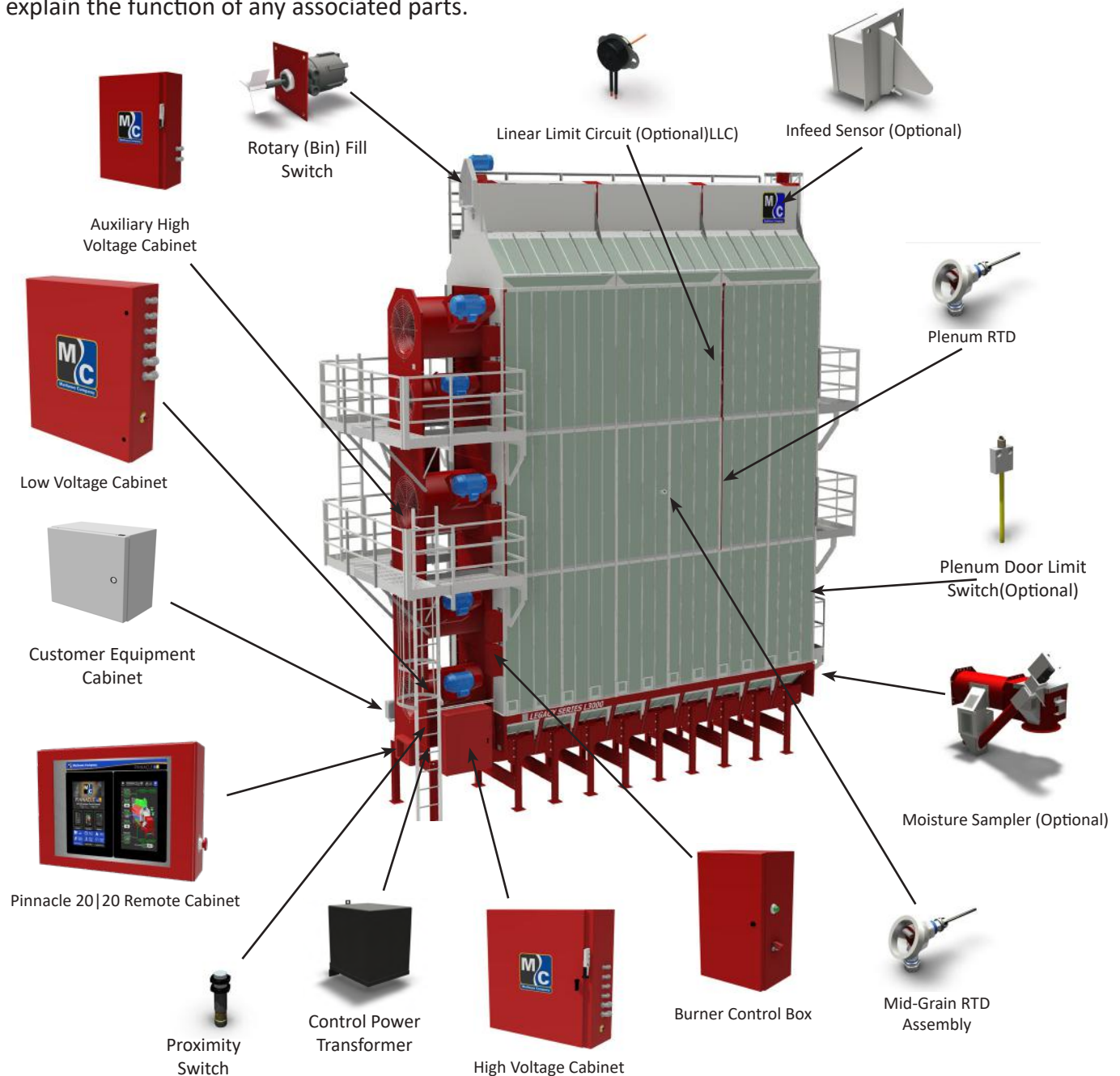



### Rotary (Bin) Fill Switch

The Rotary Fill Switch is located in the wet hopper on the opposite end of the fill tube and is powered by 24V. The switch is motorized and will rotate a paddle until wet grain comes in contact with the paddle. Once this happens, grain stops the rotation and proves the level of grain in the hopper.



### Plenum RTD

The Plenum RTD (Resistance Temperature Device) is a temperature sensing device located in the plenum used to send a signal to the PLC to establish and maintain plenum temperature.



### Mid-Grain RTD Assembly

The two Mid-Grain RTD (Resistance Temperature Device) Assemblies are located around the perimeter of the dryer and are used to detect the temperature of the grain in the column. Each of these two RTD assemblies is equipped with a 4-20mA transmitter which provides an analog input signal sent to the PLC.



### Linear Limit Circuit (LLC) Switch (if equipped)

The Linear Limit Circuit (LLC) Switch is wrapped around the screen section of the dryer and provides a safety shutdown when over-temperature is detected.



### Proximity Switch

The Proximity Switch is used to detect the rotation of the discharge metering system by sensing the proximity of a detector on the discharge metering shaft. If the rotation of the shaft goes undetected for a set duration of time, the machine will be shutdown.



### Control Power Transformer

The Control Power Transformer is used to transform a portion of the incoming electrical power to reliable 120V control power which is used to supply power to various electrical components including the PLC.

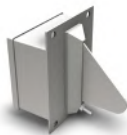

### Infeed DM510 Moisture Sensor (Optional)

The infeed moisture sensor is mandatory for AccuDry grain dryers, and optional for TruDry grain dryers. This sensor monitors incoming grain in real-time so that the AccuDry prediction model can react to incoming grain moisture changes. On an optional TruDry grain dryer, this will only display on the main screen, and will not affect the operation of the grain dryer.

## High Voltage Cabinet

The High Voltage Cabinet and associated sub-panel, shown below, contain all of the motor starters and protectors, main power disconnect, variable frequency drives (VFD's), breakers, relays, and other associated electrical hardware.

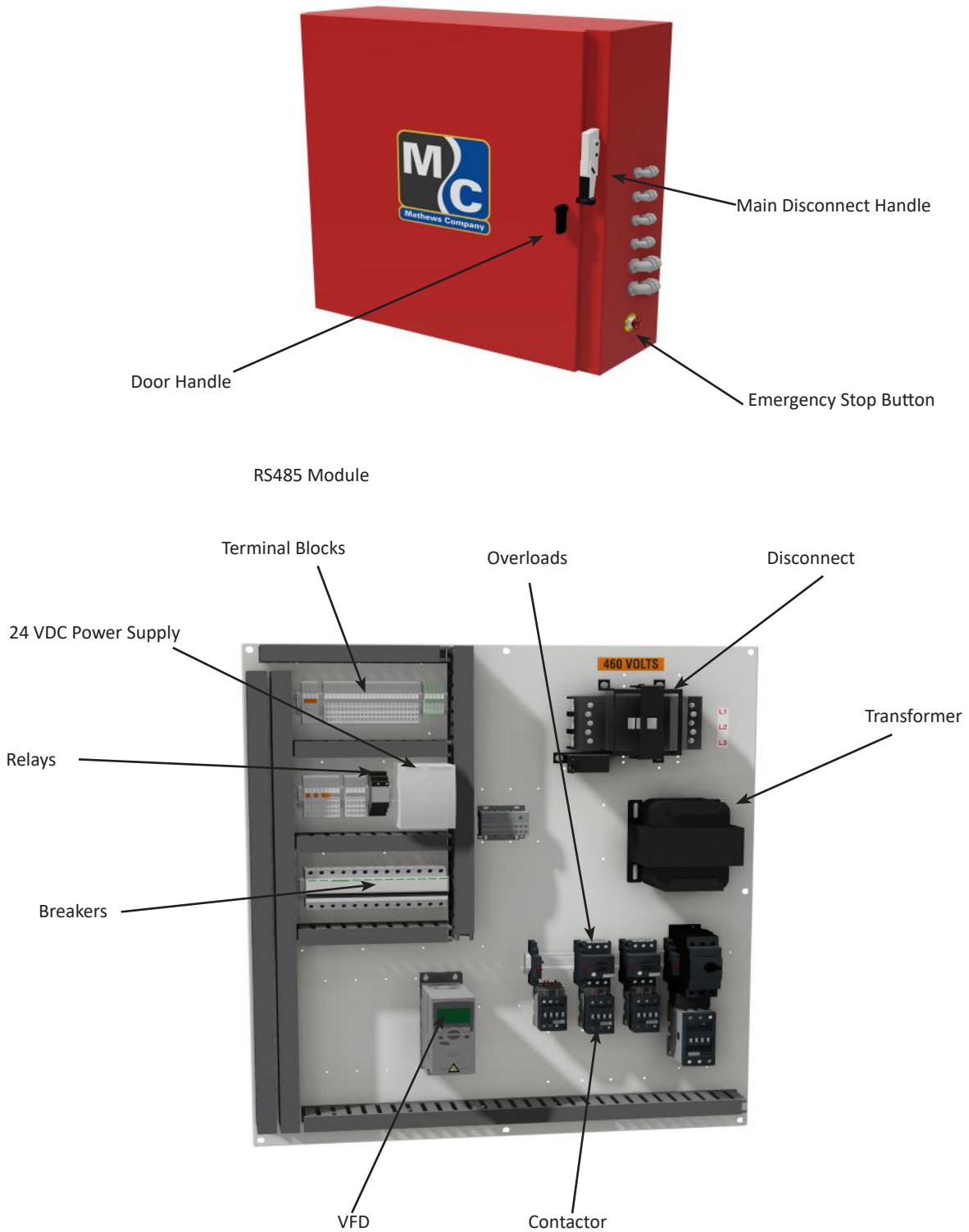

## Auxiliary High Voltage Cabinet

The Auxiliary High Voltage Cabinet and associated sub-panel, shown below, contain all of the motor starters and protectors, main power disconnect, and other associated electrical hardware for the top fans on L2000 and larger machines.

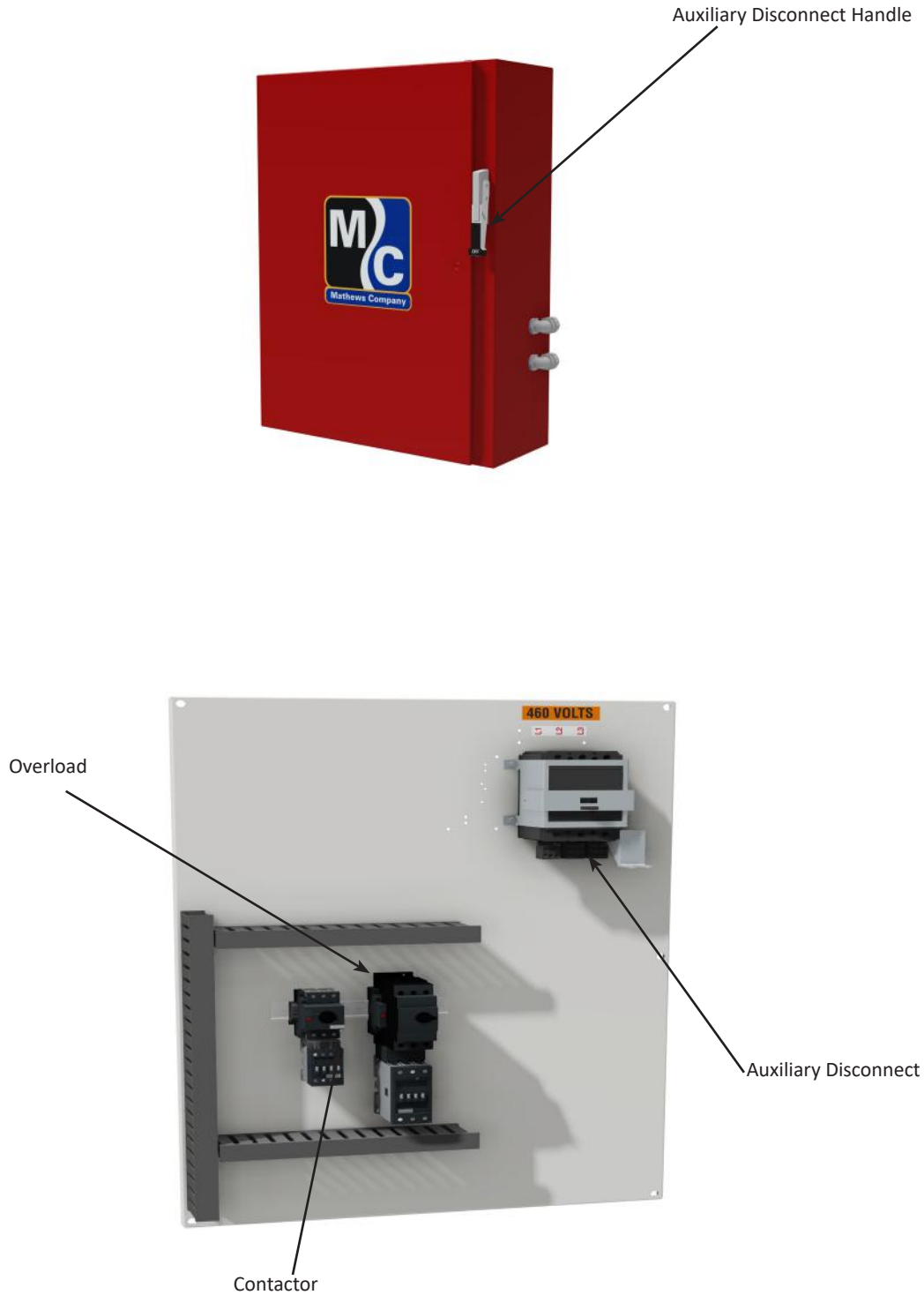

## Low Voltage Cabinet

The Low Voltage Cabinet and associated sub-panel, shown below, contain the PLC, I/O modules, breakers, relays and a safety relay module. There are two main variations which include an AccuDry and Non-AccuDry option:

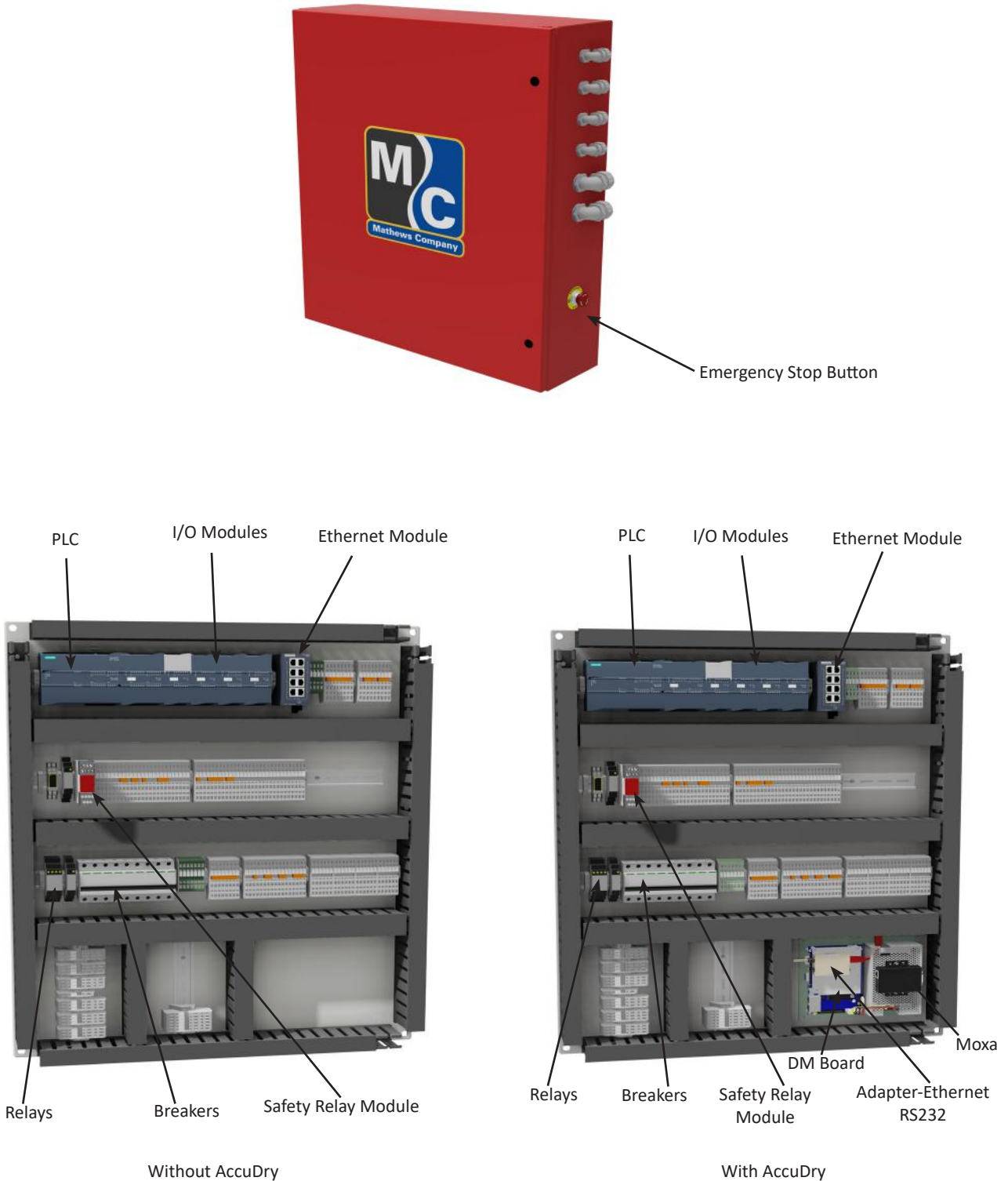

## Pinnacle 20|20 Remote Cabinet

The Pinnacle 20|20 Remote Cabinet and associated sub-panel, shown below, is where the Pinnacle 20|20 HMI touch screens are located, as well as the M-C Trax modem.

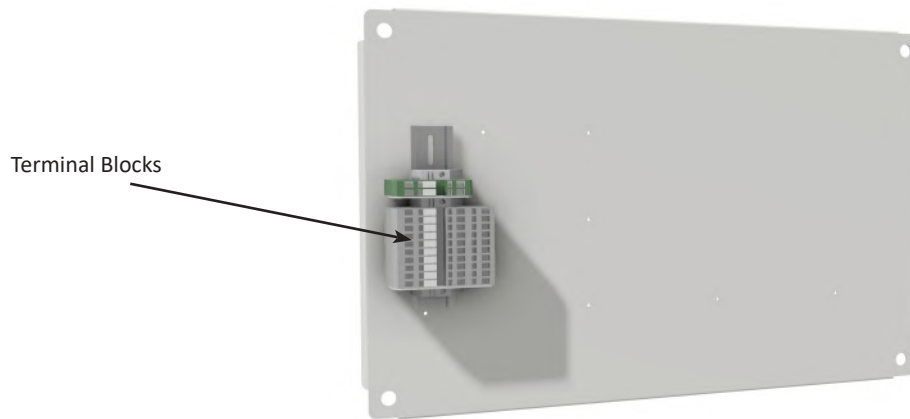

### Human Machine Interface (HMI) Touch Screen

The HMI Touch Screens are where all Pinnacle 20|20 controls and related information is displayed. See the Pinnacle 20|20 Controls Manual for more information.

## Pinnacle 20|20 Customer Equipment Cabinet

The Pinnacle 20|20 Customer Equipment Cabinet and associated sub-panel, shown below, is provided as the designated junction for wiring in customer equipment that is to be used in conjunction with the dryer operation.



Terminal Blocks

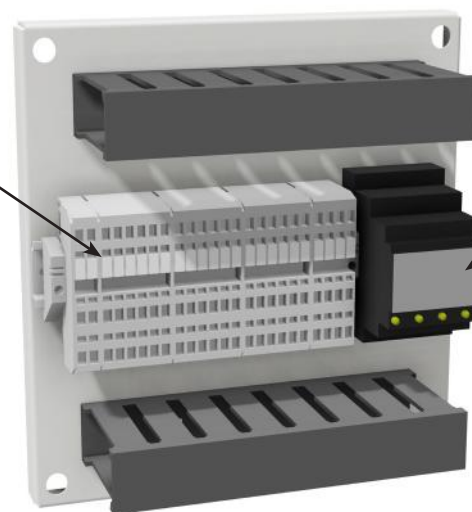

Relays



**It is extremely important not to wire any customer equipment directly into any of the dryer cabinets except for the Customer Equipment Cabinet. The Customer Equipment Cabinet is the sole, designated place to wire in customer equipment. Failure to follow this may cause damage to other dryer components and will void the warranty.**





## Burner Control Cabinet

The Burner Control Cabinet and associated sub-panel, shown below, house all of the components to safely operate the fan and burner which includes an air pressure switch, high limit switch, and an ignition board. The cabinet is mounted near the fan and burner for ease of access and/or troubleshooting purposes.

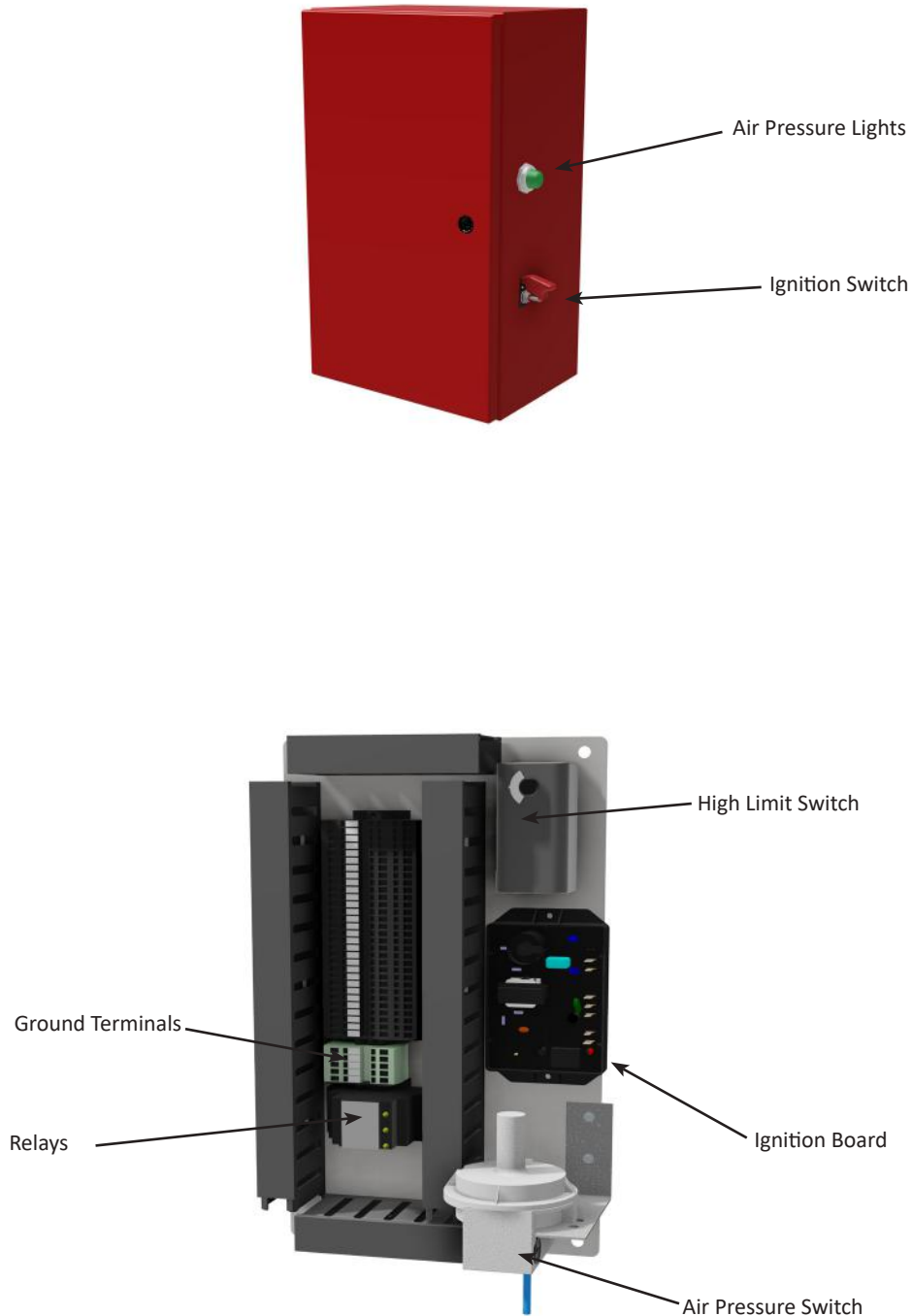



### Ignition Board

The Ignition Board controls the overall operation of the burner by supplying high voltage from the coil to the spark plug to ignite the burner, sending signals to open/close the gas valves, and continuously monitoring the presence of a flame for safe and reliable operation.



### High Limit Switch

The High Limit Switch utilizes a capillary bulb to sense an over-temperature condition in the plenum which will cause the dryer to shutdown. The high limit setpoint is adjustable on the switch and should be set approximately 40 deg F higher than the plenum temperature setpoint.



### Air Pressure Switch

The purpose of the Air Pressure Switch is to prove airflow from the fan for safe operation of the burner. The air pressure switch is adjustable and should be set once the dryer is full of grain. Adjustment of the switch is done in the burner control cabinet and indication of reaching the air pressure switch's setpoint is indicated on the green light on the outside of the burner control cabinet.



## Discharge Moisture Sampler (Optional)

The discharge moisture sampler is used to continuously collect a sample of grain, move it past the discharge moisture sensor in a controlled and steady fashion, and return the sampled grain back to the discharge of the dryer.

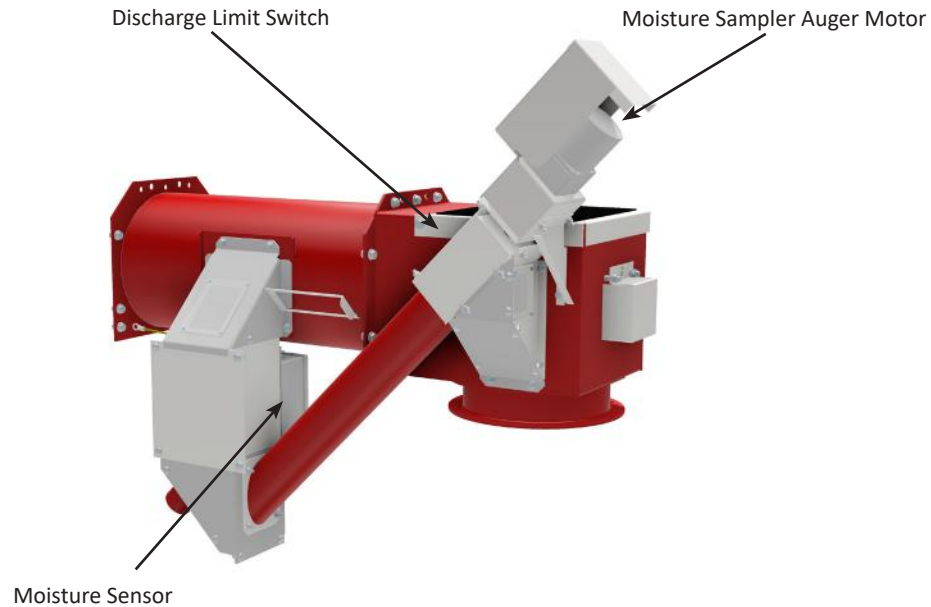

### Moisture Sensor



The Moisture Sensor is an electronic device that measures the grain moisture indirectly by measuring the capacitance of the field of grain and correlating it to a voltage. Additionally, there is a small thermistor, which also produces an analog output voltage, mounted on the face of the sensor to measure the grain's temperature to compensate the moisture reading and to provide a real-time indication of the grain's temperatures. These voltages are input to the PLC and when calibrated, will display the discharge grain moisture as well as the temperature on the HMI touchscreens.

### Discharge Limit Switch



The Discharge Limit Switch is a spring loaded lever that maintains a normally open contact which is held closed. The purpose of this switch is to detect a discharge grain overload condition that may be a result of a failed discharge auger or takeaway equipment. Once an overload conditions exists, the top door on the discharge auger will lift up and the switch will return to its normally open position; in doing so, the safety circuit is opened and the dryer is shutdown.

### Moisture Sampler Auger Motor



The Moisture Sampler Auger Motor is a small fractional HP motor that slowly augers a sample of grain past the moisture sensor and returns the sampled grain back to the primary discharge of the dryer.

## Gas Train

The purpose of the gas train is to safely and efficiently supply fuel at the correct pressures and flow rates to the burners. There are several variations of the gas train depending on what model and options are equipped on the machine.

If the dryer is equipped for LPG fuel, there will be liquid lines sending LPG to the vaporizer and back to the manifold. CE equipped machines will have gas pressure switches to meet local codes. CGA equipped machines will have valve proving shut-off valves as well as liquid and vapor venting to meet local codes.

### LPG Gas Manifold (Domestic)

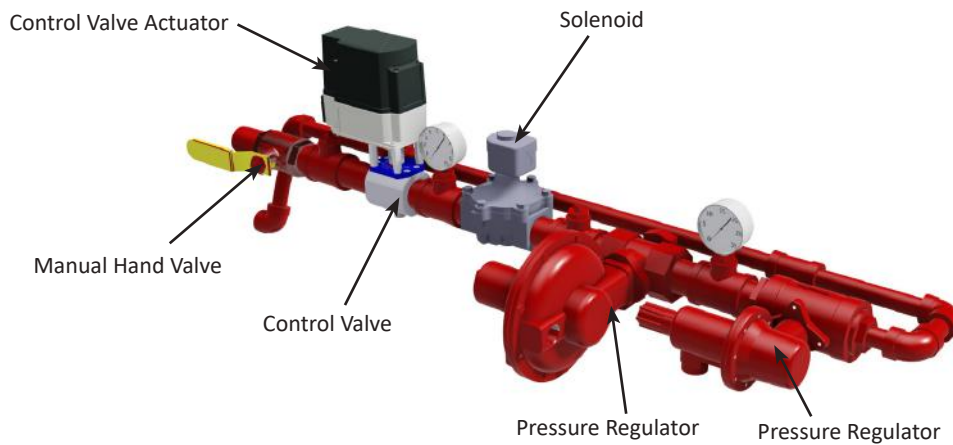

### NG Gas Manifold (Domestic)

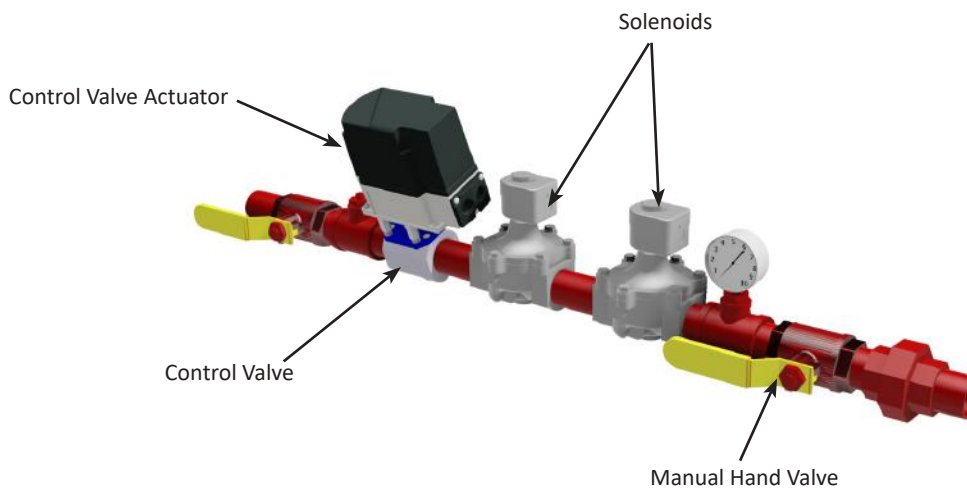

### LPG Gas Manifold (With Optional CSA Requirements)

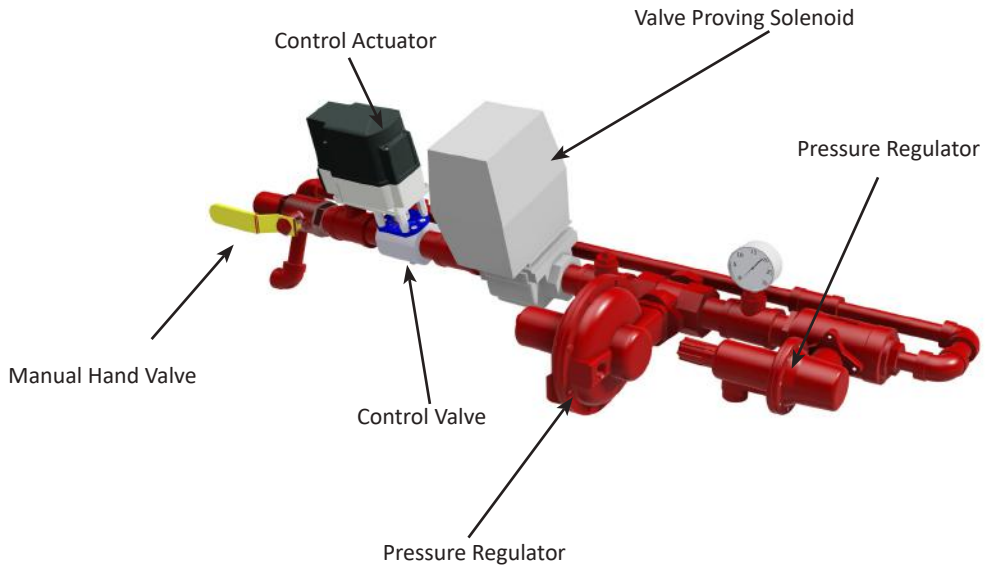

### NG Gas Manifold (With Optional CSA Requirements)

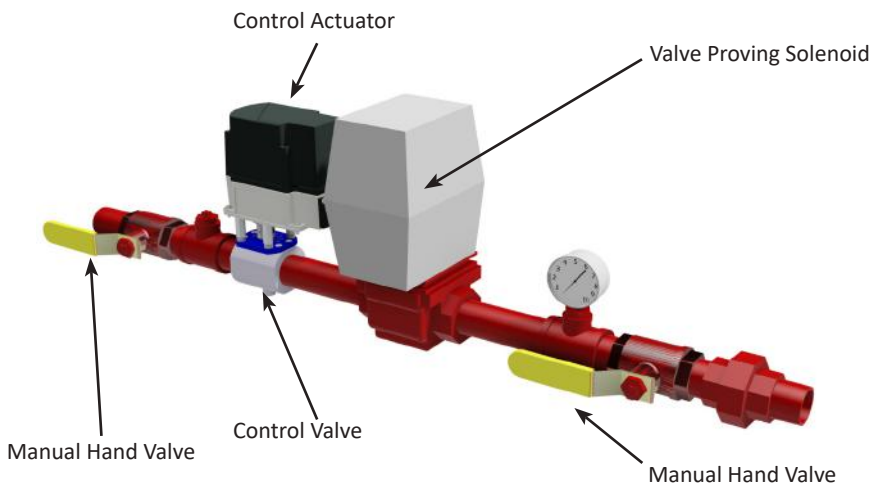

## NG Gas Manifold (With Optional CE Requirements)

(Shown with older style Control Actuator)

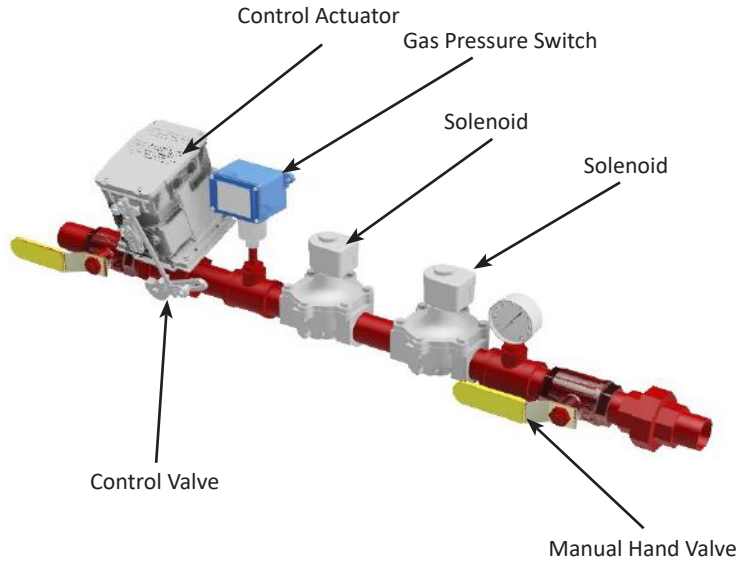

### LPG Standpipe (Domestic)

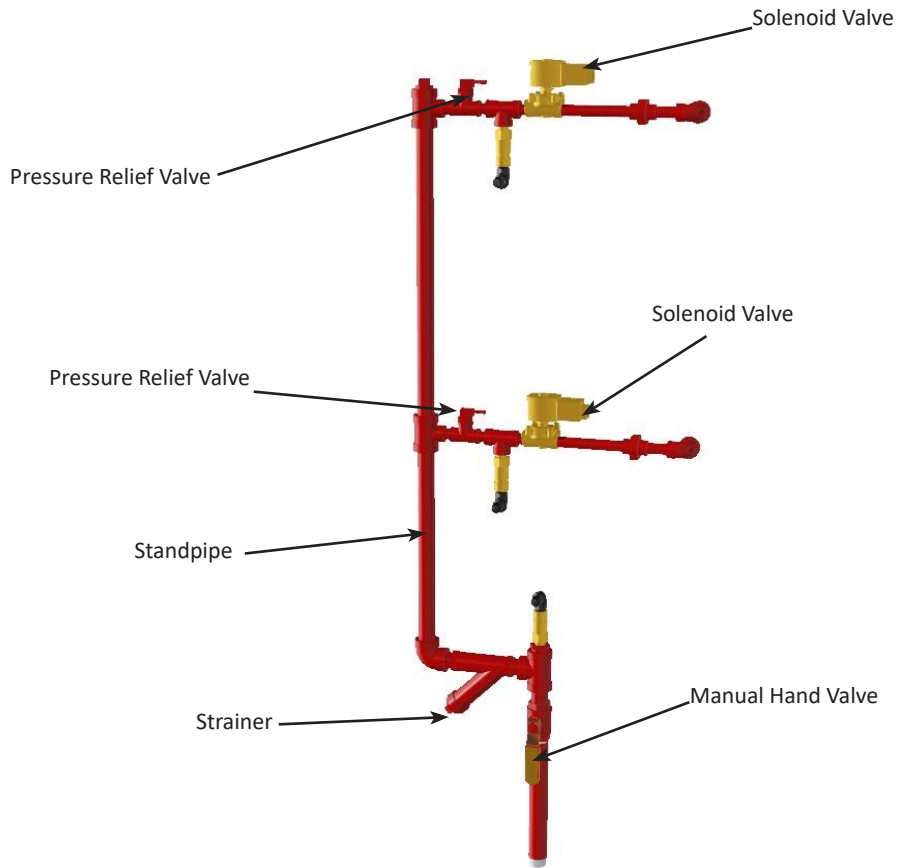

### NG Standpipe (Domestic)



### LPG Standpipe (With Optional CSA Requirements)

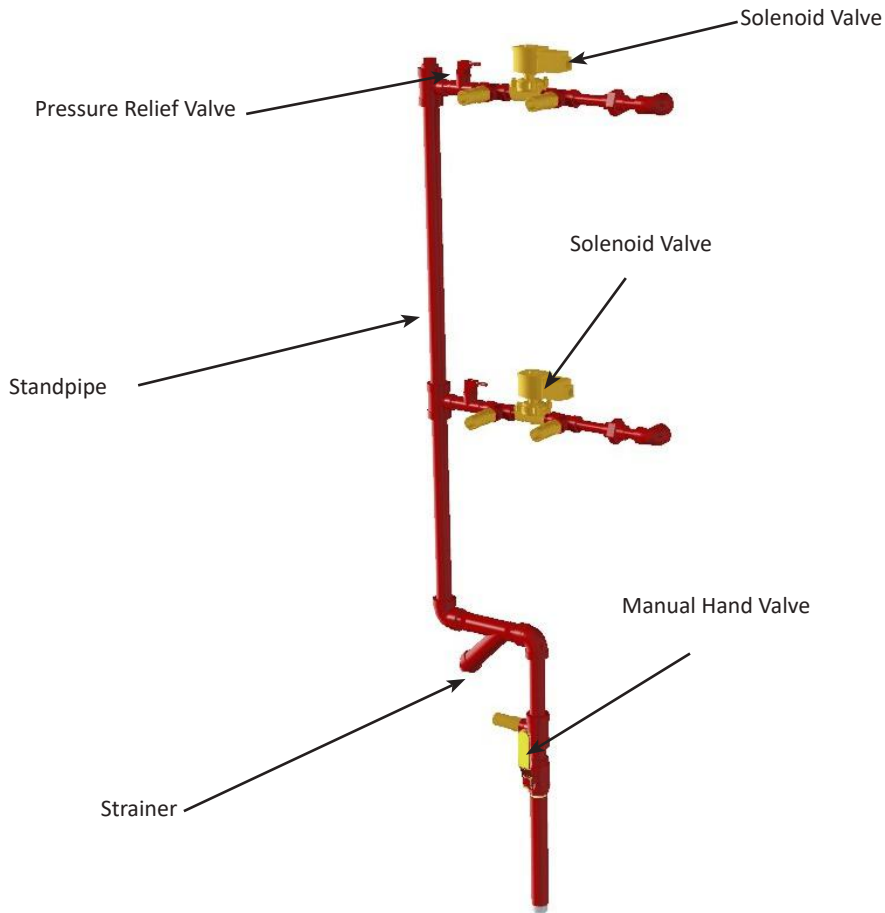

### NG Standpipe (With Optional CSA Requirements)





## NG Standpipe (With Optional CE Requirements)

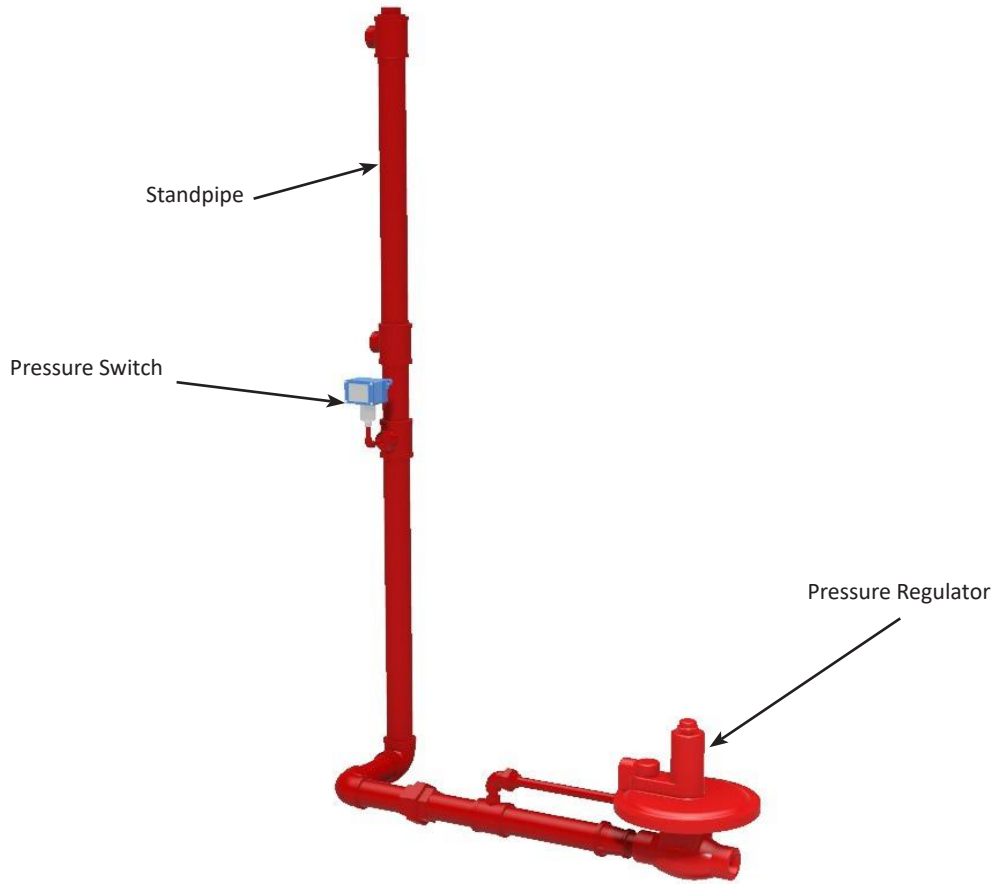



### Control Valve

The Control Valve is a throttling butterfly valve that controls the fuel flow rate to the burner which is precisely positioned by the control valve actuator. The control valve is connected to the control valve actuator through a mechanical linkage.



### Control Valve Actuator

The Control Valve Actuator is an electrical actuator that is connected to the control valve through a mechanical linkage that precisely positions it based on the output of the PLC. As the plenum temperature drops below the setpoint, the PLC commands the control valve actuator to open more, whereas if the plenum temperature rises above the setpoint, the PLC commands the control valve actuator to close more.



### Strainer

The purpose of the Strainer is to collect any foreign material with a wire mesh filter that may find its way into the fuel supply line.



### Solenoid Valve

The Solenoid Valve is to start and stop the flow of fuel to the burner. The opening/closing actuation of the solenoid valve is monitored and performed by the ignition board.



### Pressure Relief Valve

The purpose of the Pressure Relief Valve is to automatically open and relieve excess pressure when the line pressure becomes too high. Once the pressure drops, the valve will close and seal again for continued proper operation.



### Low / High Gas Pressure Switches (CE equipped machines only)

The Low / High Gas Pressure Switches are adjustable switches used to detect either low gas or high gas pressure in the gas train and shutdown the dryer. These switches are used for CE equipped machines to meet local codes.



### Pressure Regulator

The Primary purpose of a Pressure Regulator is to continuously control the supply pressure of the fuel to the gas train manifold. There are various sizes and configuration based on model and configured options, however the primary purpose is the same.



### Manual Hand Valve

The purpose of a Manual Hand Valve is to manually open and close various portion of the gas train for maintenance purposes.



### Valve Proving Solenoid

The valve proving solenoid stops and starts the flow of fuel to the burner. The opening/closing activation of the solenoid valve is monitored and performed by the ignition board. This solenoid detects proof of valve closure.



## Burner

The burner, which consists of a cast iron burner body drilled to discharge gaseous fuel between diverging stainless steel mixing plates, is a burner which efficiently combusts the fuel/air mixture thereby producing the required process heat to the drying air.

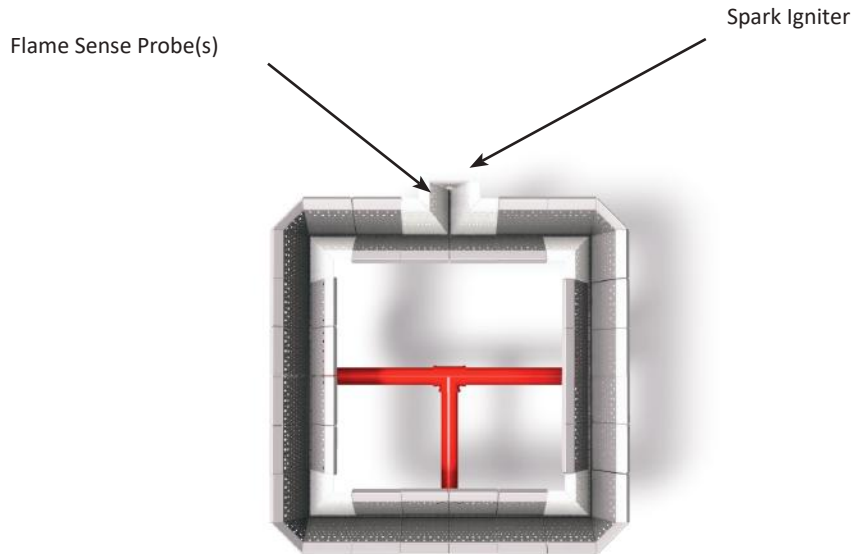

### Spark Igniter

The Spark Igniter receives high voltage current from the ignition board and sparks to provide direct spark ignition for the burner.



### Flame Sense Probe(s)\*\*

The Flame Sense Probe detects the presence of the flame and provides positive confirmation to the ignition board so that operation of the burner may continue.

\*\* Note: 2x flame sense probes may be used to detect high or low flame conditions.



# Operating Procedures

## Overview

This section will explain the operation of the primary components of the dryer as well as provide step-by-step procedures to properly start-up and shut-down the machine. Operational and functional descriptions along with adjustment details for primary components will be presented initially, followed by operational procedures for starting up and shutting down the dryer.

## Component Adjustments

The following information provides details needed to properly operate the different components of the dryer and to make any adjustments necessary. The components listed in the pages following do not comprise everything that can be adjusted on the dryer, but rather the components that need to be adjusted based on normal operation.

### Air Pressure Switch

The purpose of the Air Pressure Switch is to prove airflow from the fan for safe operation of the burner. Once the pressure switch has been satisfied, operation of the burner and its ignition system are permitted. In the event that air pressure is lost as indicated by a non-illuminated air pressure light, the burner will extinguish.

Depending on the number of burners, this will determine the number of air pressure switches, with one installed per burner. The air pressure switch is adjustable and should be set once the dryer is full of grain. Adjustment of the switch is done in the burner control cabinet and indication of reaching the air pressure switch's setpoint is indicated by the green air pressure light on the outside of the burner control cabinet.

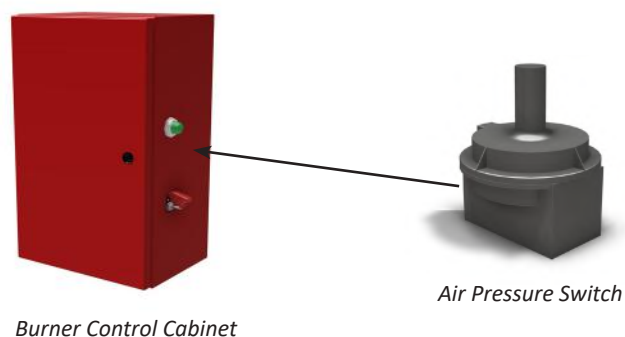

***The safety features associated with the air pressure switch(es) are for your safety and for the protection of the dryer. They should be checked for correct operation at the start of the drying season and periodically during the season as they are designed to protect the dryer from a fire that may result from fan (air flow) failure while the burner is ignited and a flame is present.***



## Setpoint Check

The following procedure shall be utilized to properly check the air pressure switch(es) setpoint. Note that the air pressure switch for each fan/burner must be checked and set independently.

1. After the dryer has been filled with grain and before the burner is ignited, the operation of each air pressure switch must be checked.
2. All of the fans must be running (including the cooling fans) before the air pressure switches can be accurately adjusted.
3. Start all fans and determine if the air pressure switch light (for the switch that is being verified) on the burner control cabinet illuminates once the respective fan has reached its normal operating speed.
4. If the indicator light does not illuminate or comes on too soon (before the fan reaches operating speed), the air pressure switch must be adjusted.

## Switch Adjustment

In the event that the indicator light does not illuminate or comes on too soon (before the fan reaches operating speed), the following procedure shall be used to properly set the air pressure switch:

1. Remove the cap on the air pressure switch. Inside the air pressure switch use the slotted screw to make adjustments by turning clockwise or counter-clockwise.
2. Turn the adjusting screw counter-clockwise until the air pressure light comes on. After the air pressure light comes on, turn the adjusting screw counter-clockwise an additional  $\frac{1}{4}$  to  $\frac{1}{2}$  turn to allow for normal changes in static pressure.

If all air pressure switch adjustment is used and the air pressure light does not illuminate, the air pressure switch is defective and must be replaced. Once the switch is replaced, check its operation and make adjustments as previously outlined.

## High Limit Switch

The purpose of the High Limit Switch is to provide a safety shutdown in the event that the temperature in any of the plenums has exceeded the high limit setpoint. The high limit switch senses the temperature in the plenum that it is monitoring by means of a capillary bulb temperature sensing device.

Depending on the number of burners, this will determine the number of high limit switches, with one installed per burner. The high limit switch is adjustable and should be set once at the start of a drying season or for a given grain. Adjustment of the switch is done in the burner control cabinet. Note that when a high limit setpoint is exceeded, the high limit for the applicable fan/burner will become tripped as well as all other high limit switches above it because the wiring of the switches are in series. For example on a 6-fan/burner system, if high limit in plenum #3 is exceeded, the high limit for plenum 3 through 6 will no longer show to be in good status.

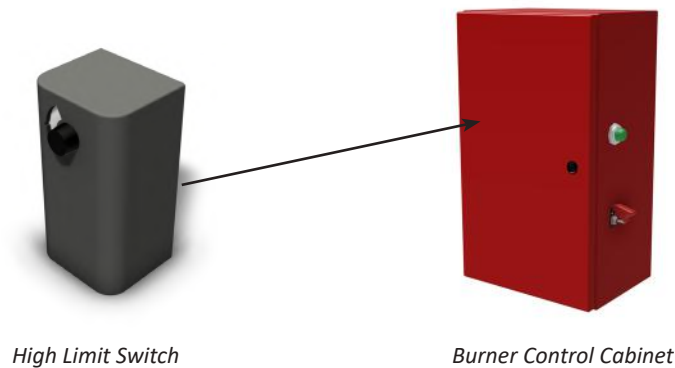

*The safety features associated with the high limit switch(es) are for your safety and for the protection of the dryer. They should be checked for correct operation at the start of the drying season and periodically during the season as they are designed to protect the dryer from a fire that may result from fan (air flow) failure while the burner is ignited and a flame is present.*

### Setpoint Check and Switch Adjustment

The following procedure shall be utilized to properly check the high limit switch(es) setpoint. Note that the high limit switch for each fan/burner must be checked and set independently. Once the high limit setpoint has been reached, the switch will need to be reset by pressing the small reset button on the top of the device.

After the dryer has been filled with grain and after the burner is ignited, the operation of each high limit switch must be checked.

1. Start the fan, ignite the burner and establish a stable temperature in the plenum.
2. Inside the burner control cabinet, adjust the high limit switch setpoint by turning the small dial counter-clockwise to a temperature below the current temperature in the plenum.
3. Once the high limit switch determines that the temperature in the plenum has exceeded the high limit setpoint, the switch will cause the dryer to shutdown.
4. If the high limit switch does not shut down the dryer, it is defective and must be replaced. Once the switch is replaced, check its operation and make adjustments as previously outlined.
5. If the setpoint is exceeded and properly shuts down the dryer, the setpoint can be adjusted to a value that is approximately 40 deg F above the desired plenum temperature.



### Variable Frequency Drive (VFD)

The variable frequency drive control the speed of the discharge metering rolls. The communication from the HMI to the PLC then correlates to the variable frequency drive. It is important to note that some of the parameters listed below will vary such as voltage, amperage and motor speed. These values should match the motor name plate.

#### VFD Parameters:









Drive Parameters	Description	ABB Factor Settings	Metering VFD
9901	Language	English	English
9902	Applied macro	ABB Standard	ABB Standard
9904	Control Mode	Scalar-Freq	Scalar-Freq
9905	Nominal Voltage		Dryer voltage
9906	Nominal Current		Nameplate FLA
9907	Nominal Frequency	60 Hz	60 Hz
9908	Nominal Speed	1700 rpm	Motor nameplate
1001	EXT 1 Commands	DI1,2	DI1
1002	EXT 2 Commands	NOT SEL	DI1
1003	Direction	Request	Forward
1102	EXT1/EXT2 Select	EXT1	DI2
1103	Ref. 1 Select	AI1	AI1
1104	Ref. 1 MIN	0 Hz	0 Hz
1105	Ref 1 MAX	60 Hz	60 Hz
1106	Ref. 2 Select	AI2	Keypad
1107	Ref. 2 MIN	0%	0%
1108	Ref. 2 MAX	100%	100%
1201	Const. Speed Select	DI3,4	NOT SEL
1401	Relay Output 1	Fault(-1)	Fault(-1)
1501	AO1 Content Sel.	Output Freq.	Ext. Ref. 1
1601	Run Enable	NOT SEL	DI3
2003	Max Current		FLA X SF
2007	Min Frequency	0 Hz	0 Hz
2008	Max Frequency	60 Hz	60 Hz
2102	Stop Function	Coast	Ramp
2110	Torque boost current	100%	200%
2202	Accel Time 1	5 sec	5 sec
2203	Decel Time 1	5 sec	5 sec
3415	Signal 3 Parameters	Torque	DI1-5

**\*Dip switches must both be set to ON for SIEMENS S7-1200!**

**\*\*If programmed by hand, upload to panel, then download full set to drive**

## Changing Variable Frequency Drive Parameters

### Direction of the Motor Rotation

- Check the direction of the motor rotation.
  - If the drive is in remote control (REM shown on the left), switch to local control by pressing .
  - To go to the Main menu, press  if the bottom line shows OUTPUT; otherwise press  repeatedly until you see MENU at the bottom.
  - Press keys / until you see “rEF” and press .
  - Increase the frequency reference from zero to a small value with key .
  - Press  to start the motor.
  - Check that the actual direction of the motor is the same as indicated on the display (FWD means forward and REV reverse).
  - Press  to stop the motor.

To change the direction of the motor rotation:

- Invert the phases by changing the value of parameter **9914** to the opposite, ie from 0 (**NO**) to 1 (**YES**), or vice versa.
- Verify your work by applying input power and repeating the check as described above.

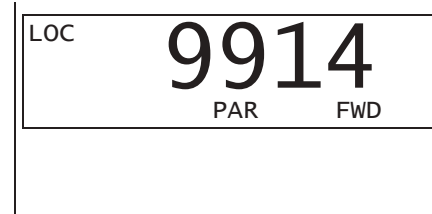
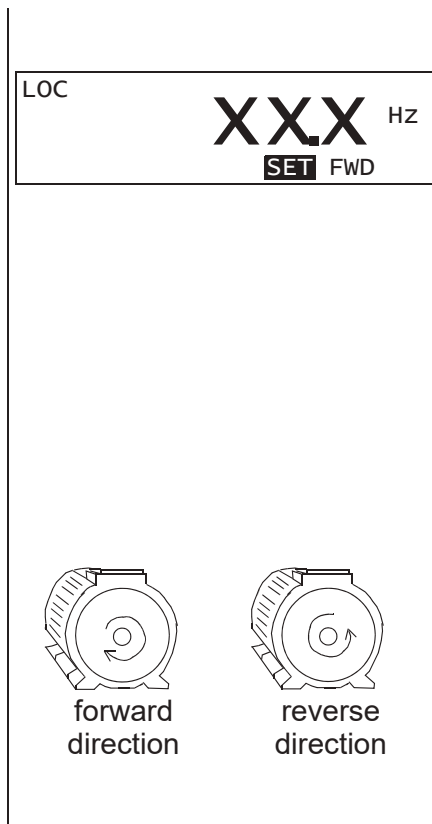

### Speed Limits and Acceleration/Deceleration Times

- Set the minimum speed (parameter **2001**).
- Set the maximum speed (parameter **2002**).
- Set the acceleration time 1 (parameter **2202**).
 

**Note:** Set also acceleration time 2 (parameter **2205**) if two acceleration times will be used in the application.
- Set the deceleration time 1 (parameter **2203**).
 

**Note:** Set also deceleration time 2 (parameter **2206**) if two deceleration times will be used in the application.





## Operational Procedures

The following operational procedures provide a step-by-step guide to starting-up and shutting-down your dryer. These procedures should be followed and used in conjunction with the Pinnacle 20|20 Controls Manual for HMI touchscreen adjustments.

### First Time Start-Up

This start-up procedure assumes that the dryer has not recently been in operation and is not full of grain. For a repeated daily start-up, see the Daily Start-Up procedure portion of this section of the manual.

1. Adjust the high limit switch setpoint to approximately 40 deg F above the desired plenum temperature as explained in the High Limit portion of this section of the manual. This should be done for all plenum high limit switches.
2. Set the grain fill timers as explained in the Settings Chapter of the Pinnacle 20|20 Controls Manual.
3. Turn the main disconnect located on the High Voltage Cabinet(s) to the on position.
4. On the Remote Cabinet, go to the Controls page on one of the HMI's and press the Control Power TURN ON button.
5. On the same Controls page, press one of the Fan START buttons. The fan should start immediately.. Repeat this procedure for all of the fans, allowing time for each fan to get up to speed before starting the next.
6. On the Remote Cabinet, go to the Grain Fill Settings page on one of the HMI's and check the "Fill From Empty" box. Next, press the Grain Fill START button. The level auger should start immediately and your grain fill equipment should be commended to deliver grain to the dryer.
7. Once the dryer is full of grain, adjust each of the air pressure switches so the air pressure light illuminates as explained in the Air Pressure Switch portion of this section of the manual.
8. Set the plenum temperature setpoints for each plenum. Refer to the table at the end of this section for suggested drying temperatures based on model number and grain type. Setting the plenum temperature can be done on the HMI touchscreens as explained in the Pinnacle 20|20 Controls Manual.
9. Open all manual gas supply valves so that fuel is free to flow to the burner once the gas valves controlled by the ignition system are opened.
10. On the Remote Cabinet, from the Controls page on one of the HMI's, press the Burner START button. After a 15 second delay, the burner should be lit. Repeat for all necessary burners.
11. Allow the dryer to warm up and dry the initial load of grain as a batch operation or be prepared to cycle the first batch back into the wet bin so that it may be processed through the dryer again on a continuous flow basis.
12. On the Remote Cabinet, from the Grain Fill Settings page on one of the HMI's, uncheck the Fill From Empty box. The grain fill system will now operate automatically as outlined in the Grain Fill Settings portion of the Pinnacle 20|20 Controls manual.
13. Refer to the Pinnacle 20|20 Controls Manual for the requirements prior to starting the dryer's discharge. At a minimum, set the discharge mode to Manual on the HMI touchscreen and set the discharge speed setpoint (%) in accordance with the table that follows.
14. On the Remote Cabinet, from the Control page on one of the HMI's, press the Takeaway START button. Once the discharge auger or conveyor (if equipped) as well as customer takeaway equipment are running, press the Metering START button. The dryer is now discharging grain and the discharge rate



will be established by the Pinnacle 20|20 Control System. Refer to the Pinnacle 20|20 Controls Manual for more information.

### Daily Shut-Down

This shutdown procedure assumes that the dryer will be put back into operation within 24-48 hours. If the grain drying operation will not resume within 24-48 hours, it is suggested that the dryer be emptied and the grain placed back into the appropriate storage. Grain dryers are not designed to be grain storage devices. Once all the grain has been dried, it needs to be emptied from the dryer and stored appropriately. Grain stored in a dryer for more than one week may cause damage to the machine. For an end-of season shut-down procedure, see the End-of-Season Shut Down portion of this section of the manual.

1. On the Remote Cabinet, from the Controls Page on one of the HMI's, press the Metering STOP button. Once takeaway equipment is clear of grain, press the Takeaway STOP button.
2. On the same Controls page, press the Grain Fill STOP button. The grain fill system will now be shutdown and your fill equipment will no longer be commanded to run.
3. Close the manual hand valves supplying fuel to the dryer. This will ensure the burners will run until all of the fuel in the line has been cleared out. Once the burners are extinguished, from the Controls page on one of the HMI's, press the Burner STOP buttons for each burner.
4. Let the fans continue to run for at least 15-20 minutes to cool the grain in the dryer. Once the grain has been cooled down, shutoff the fans by pressing the Fan STOP buttons on the Controls page.
5. From the Controls page, press the Control Power TURN OFF button.
6. Turn the main disconnect located on the High Voltage Cabinet(s) to the off position.



## Daily Start-Up

This start-up procedure assumes that the dryer has recently been in operation and is full of grain. For a first time start-up, see the Daily Start-Up procedure portion of this section of the manual.

1. Turn the main disconnect located on the High Voltage Cabinet(s) to the on position.
2. On the Remote Cabinet, go to the Controls page on one of the HMI's and press the Control Power TURN ON button.
3. On the same Controls page, press one of the Fan START buttons. The fan should start immediately. Repeat this procedure for all of the fans, allowing time for each fan to get up to speed before starting the next.
4. Set the plenum temperature setpoints for each plenum. Refer to the table at the end of this section for suggested drying temperatures based on model number and grain type. Setting the plenum temperature can be done on the HMI touchscreens as explained in the Pinnacle 20|20 Controls Manual.
5. Open all manual gas supply valves so that fuel is free to flow to the burner once the gas valves controlled by the ignition system are opened.
6. On the Remote Cabinet, from the Controls page on one of the HMI's, press the Burner START button. After a 15 second delay, the burner should be lit. Repeat for all necessary burners.
7. On the Remote Cabinet, from the Grain Fill Settings page on one of the HMI's, uncheck the Fill From Empty box. The grain fill system will now operate automatically as outlined in the Grain Fill Settings portion of the Pinnacle 20|20 Controls manual.
8. Refer to the Pinnacle 20|20 Controls Manual for the requirements prior to starting the dryer's discharge. At a minimum, set the discharge mode to Manual on the HMI touchscreen and set the discharge speed setpoint (%) in accordance with the table that follows.
9. On the Remote Cabinet, from the Control page on one of the HMI's, press the Takeaway START button. Once the discharge auger or conveyor (if equipped) as well as customer takeaway equipment are running, press the Metering START button. The dryer is now discharging grain and the discharge rate will be established by the Pinnacle 20|20 Control System. Refer to the Pinnacle 20|20 Controls Manual for more information.

## End-of-Season Shut-Down

This shutdown procedure assumes that the dryer will not be put back into operation for an extended period of time and that all of the grain in the dryer will be dried and then subsequently emptied.

1. When the last of the grain to be dried has been put into the dryer, press the Metering STOP button. Once takeaway equipment is clear of grain, press the Takeaway STOP button.
2. Dry the remaining grain for approximately six minutes per point of moisture to be removed.
3. Close the manual hand valves supplying fuel to the dryer. This will ensure the burners will run until all of the fuel in the line has been cleared out. Once the burners are extinguished, from the Controls page on one of the HMI's, press the Burner STOP buttons for each burner.
4. Let the fans continue to run for at least 15-20 minutes to cool the grain in the dryer. Once the grain has been cooled down, shutoff the fans by going to the Controls page on one of the HMI's, and press the Fan STOP buttons for each fan.
5. Set the discharge mode to Manual on one of the HMI touchscreens and set the discharge speed setpoint (%) as high as your takeaway system will allow.



6. On the Remote Cabinet, from the Control page on one of the HMI's, press the Takeaway START button. Once the discharge auger or conveyor (if equipped) as well as customer takeaway equipment are running, press the Metering START button. The dryer is now discharging grain and the discharge rate will be established by the Pinnacle 20|20 Control System. Refer to the Pinnacle 20|20 Controls Manual for more information.
7. Allow the grain to be completely emptied from the dryer.
8. On the Remote Control Cabinet, from the Controls Page, press the Control Power TURN OFF button.
9. Turn the main disconnect located on the High Voltage Cabinet(s) to the off position.
10. Refer to the Maintenance section of this manual for additional information on preparing your dryer for an extended shutdown.



## Suggested Plenum Temperatures

Bellow are suggested plenum drying temperatures for a variety of grain types. These numbers represent the temperature that the burner will be putting out into the heating chamber.

Model Number	Plenum Number	Plenum Drying Temperature					
		Corn		Sorghum & Wheat		Canola, Rape, Sunflower Oats, Barley, Soybeans	
		deg F	deg C	deg F	deg C	deg F	deg C
L1000	Top #2	230	110	170	77	140	60
	Bottom #1	Cool or 180	Cool or 82	Cool or 150	Cool or 66	Cool or 130	Cool or 54
L1500	Top #3	235	113	180	82	140	60
	Mid #2	225	109	160	71	130	54
	Bottom #1	Cool or 200	Cool or 93	Cool or 140	Cool or 60	Cool or 120	Cool or 49
L2000	Top #4	240	116	180	82	140	60
	Top #3	235	113	170	77	130	54
	Mid #2	225	109	160	71	120	49
	Bottom #1	Cool or 200	Cool or 93	Cool or 150	Cool or 66	Cool or 120	Cool or 49
L3000	Top #5	240	116	180	82	140	60
	Top #4	235	113	170	77	140	60
	Mid #3	225	109	160	71	130	54
	Mid #2	200	93	150	66	120	49
	Bottom #1	Cool or 180	Cool or 82	Cool or 150	Cool or 66	Cool or 120	Cool or 49
L4000	Top #6	240	116	180	82	140	60
	Mid #5	235	113	170	77	140	60
	Mid #4	225	109	160	71	130	54
	Mid #3	210	99	150	66	130	54
	Mid #2	Cool or 200	Cool or 93	Cool or 150	Cool or 66	Cool or 120	Cool or 49
	Bottom #1	Cool or 180	Cool or 82	Cool or 150	Cool or 66	Cool or 120	Cool or 49
L5000	Top #7	240	116	180	82	140	60
	Mid #6	235	113	170	77	140	60
	Mid #5	225	109	170	77	130	54
	Mid #4	215	102	160	71	130	54
	Mid #3	210	99	150	66	130	54
	Mid #2	Cool or 200	Cool or 93	Cool or 150	Cool or 66	Cool or 120	Cool or 49
	Bottom #1	Cool or 180	Cool or 82	Cool or 150	Cool or 66	Cool or 120	Cool or 49
L6000	Top #8	240	116	180	82	140	60
	Mid #7	235	113	170	77	140	60
	Mid #6	230	111	170	77	130	54
	Mid #5	225	109	170	77	130	54
	Mid #4	215	102	160	71	130	54
	Mid #3	210	99	150	66	130	54
	Mid #2	Cool or 200	Cool or 93	Cool or 150	Cool or 66	Cool or 120	Cool or 49
	Bottom #1	Cool or 180	Cool or 82	Cool or 150	Cool or 66	Cool or 120	Cool or 49

## Suggested Discharge Rate

Below are suggested discharge rate when drying at a variety of moisture levels. These numbers represent the speed on how fast or slow the dryer unloads the grain.

	All Heat						Heat + Cool					
	20%-15% Moisture			25%-15% Moisture			20%-15% Moisture			25%-15% Moisture		
	bu/hr	tonnes/hr	speed	bu/hr	tonnes/hr	speed	bu/hr	tonnes/hr	speed	bu/hr	tonnes/hr	speed
<b>L1000</b>	1,270	29.6	59%	600	14.0	28%	700	16.3	33%	390	9.1	18%
<b>L1500</b>	1,830	42.6	85%	880	20.5	41%	1,050	24.5	49%	600	14.0	28%
<b>L2000</b>	2,220	51.7	100%	1,040	24.2	49%	1,320	30.7	62%	750	17.5	35%
<b>L3000</b>	3,060	71.3	71%	1,460	34.0	34%	1,700	39.6	40%	940	21.9	22%
<b>L4000</b>	3,910	91.1	91%	1,860	43.3	43%	2,280	53.1	53%	1,300	30.3	30%
<b>L5000</b>	4,770	111.1	100%	2,280	53.1	53%	2,870	66.9	67%	1,660	38.7	39%
<b>L6000</b>	5,600	130.4	100%	2,680	62.4	63%	3,470	80.8	81%	2,000	46.6	47%

\*Note: May need to run at lower plenum temperatures for low moisture removal when drying in all heat.





# Maintenance

## Overview

This section of the manual will explain the factory recommended maintenance and cleaning requirements to keep your Mathews Company grain dryer running efficiently. Failure to follow or comply with these recommendations will impact dryer performance and may limit or void your warranty.

## Pre-Season Checks

The following pre-season checks are intended to prepare your dryer for operation and bring any issues that may be present to your attention. Performing these check no later than 1-2 months before you intend to use the machine is recommended so that proper service can be performed and/or replacement parts can be ready before the harvest season begins.

### Grain Fill & Discharge System

The following procedure will guide you through the grain fill and discharge system pre-season check. If the results of any of the following procedures are not consistent with what you should observe, service and/or replacement parts may be required. Contact your dealer or refer to the Troubleshooting section of this manual for more information.

1. Turn all of the circuit breakers in the cabinet on. Turn the electric power supply to the dryer on.
2. On the Remote Control Cabinet, turn Power On through one of the HMI's by pressing the Control Power TURN ON button on the Controls page. The button should read ON and be illuminated green with a surrounding glow.
3. On the same Controls page, press the Grain Fill START button. The level auger should start immediately.
4. On the same Controls page, press the Takeaway START button. The discharge auger or conveyor (if equipped) should start immediately.
5. On the same Controls page, press the Metering START button. The metering rolls should start turning.

### Belt Adjustment

All belts will eventually seat themselves in the pulley grooves and the tension may have to be re-adjusted. If the belts squeal when the motor starts, they are not tight enough. Never apply belt dressing as this will damage the belt and cause early belt failure.

#### **Discharge Auger Belt**

To adjust the belt tension on the discharge auger, loosen the unload auger motor mounting locknuts. Turn the locknut on the J-bolt to adjust the tension.

#### **Level Auger Belt**

Adjust the belt tension for the level auger by loosening the locknuts and raising the motor mount plate evenly with the four adjusting nuts, and then tighten the locknuts.





## Fans & Burners

The following procedure will guide you through the fan and burner system pre-season check. Perform this procedure for all fans and burners installed on the machine. If the results of any of the following procedures are not consistent with what you should observe, service and/or replacement parts may be required. Contact your dealer or refer to the Troubleshooting section of this manual for more information.

1. Turn the electric power supply to the dryer off.
2. Close the burner gas manifold hand valve for each burner (handle 90° relative to the piping).
3. In order to test the burners without grain in the dryer, the air pressure switches will need to be jumpered. To do this, place a jumper between terminal 343 (power) and 912 (air pressure switch 1) to jumper air pressure switch 1. To jumper the other air pressure switches, 1 through 8, place the jumper between 343 and the following terminals respectively: 912, 922, 932, 942, 952, 962, 972 and finally, 982 for the eighth air pressure switch.



***This is only a temporary procedure for checking the burner. Under normal operation, never operate the dryer with the air pressure switches disconnected or bypassed. This safety air pressure switch is for your protection and the protection of the dryer.***

4. Open all manual gas supply valves so that fuel is free to flow to the burner once the gas valves controlled by the ignition system are opened.
5. Turn the electric power supply to the dryer on.
6. On the Remote Control Cabinet, turn Power On through one of the HMI's by pressing the Control Power TURN ON button on the Controls page. The button should read ON and be illuminated green with a surrounding glow.
7. On the same Controls page, press the Fan START button. The Fan should start immediately and the air pressure light should illuminate.
8. Open the manual gas valve 1/4 of the way open to control the fuel flow to the burner once it has been lit
9. On the same Controls page, press the Burner START button. The burner should go through it's sequence and light.
10. Let the burner run for at least two minutes to verify that it is properly operating.



## Lubrication

Maintaining proper lubrication of all moving components of your dryer is key to its efficient and safe operation. The following table below outlines all recommended lubrication. Note that some of the items may not be applicable based on configured options, model or accessories.

Item	Lubrication Required	Interval
50:1 Gearbox Oil Level	Fill 1/4" over gear with SAE 90 gear lubricant	Maintain proper level. Check every 100 hours
50:1 Gearbox Grease Fitting	Uses (5) strokes of gun grease	At the beginning and end of the season.
Universal Joints	Use (1) strokes of gun grease	Every 50 hours of operation.
Motors	Lubricate with SR-2 (Chevron) grease or equivalent	Prior to operation and at the end of the season.
Motor Bearings	Use Exxon Corp-Ployrex-EM products or Chevron, Inc-SRI#2. Grease should be lithium based.	At the beginning and the end of the season.
Centrifugal Fan Bearings	Use only #2 consistency lithium based grease with high quality mineral oil with rust and oxidation inhibitor. Use Shell Alvania #2 Mobil Mobilux #2 or Texaco Multifak #2	At the beginning of the season and every 100 hours until the end of the season.
Unload Auger Bearings	Shell Avania #2, Mobil Mobilux #2 or Texaco Multifak #2	Grease every 100 hours, unless extremely dirty conditions, once daily / weekly.
Metering Roll Bearings	Use grade #2 mineral oil lithium or lithium complex base grease.	At the beginning and the end of the season. Internal bearings are brass and do not need lubrication.

## Seasonal Cleaning

During the course of the drying season, it is important to keep the dryer operating at its peak efficiency by performing periodic maintenance and cleaning of the equipment. When the screens of a dryer are clean, the air moves freely through the grain walls. As debris builds up inside the dryer, this can result in the combustion of debris which may lead to a fire. As such, cleaning of the grain dryer should be performed on a daily basis. Try to keep the surroundings of the dryer clean at all times to prevent breeding grounds for insects and other pests.



The recommended method for cleaning the dryer is air or water, preferably from a compressed-air source or even a vacuum, however, using a non-metallic brush or broom also works. Be aware that if using water to clean the dryer, the combination of water and residue can form a paste, making the surfaces sticky and more difficult to remove.

### Outer Screens

The outer screens of the dryer need to be kept as clean as possible for safety and performance reasons. The perforation of the screens allow heated air, saturated with moisture from the grain, to exit to the atmosphere. This process also creates a damp environment on the outside of the screens, creating a buildup of fines and dust which reduces air flow resulting in a decrease of capacity and higher cost of drying.

Cleaning of the outer screens can be done during the drying process, but it may temporarily affect the discharge capacity if water is used. The preferred way to clean is to brush down the screens while grain is being dried as this will help push material out of the perforations in the screens. The discharge rate should increase after cleaning of the dryer because more surface area is now being exposed to the heated air passing through the grain columns.

### Inner Screens

The procedure for cleaning the inner screens is similar to that of cleaning the outer screens. When cleaning the inside of the dryer, the use of a protective breathing mask is recommended. Using a non-metallic brush or broom, sweep the inner screens and channel rings going from top to bottom. Check the burner to make sure the wires look good and the burner is clean of debris. Sweep the plenum floors and remove any debris.

## **Post-Season Maintenance**

After the drying season, the following steps are recommended to put your dryer into a condition suitable for an extended period of non-operational time.

1. Disconnect all power and turn off the gas supply.
2. Perform one final cleaning of the dryer inside and out as previously explained in the Seasonal Cleaning section of the manual. Use a power washer on the outer screens if dirt has filled the perforations on the screens.
3. Open the plenum access doors and sweep out all foreign material.
4. Visually inspect all bearings to see if there is indication of one in need of replacement. Inspect the drive belts and chains and note if any are in need of replacement or lubrication.
5. Grease all fan motor bearings and fan bearings as recommended in the Lubrication section of the manual.
6. Use a vacuum cleaner to remove any dirt from the control cabinet.



# Troubleshooting

The Troubleshooting section will help with diagnosing the dryer in case of a dryer shut down. This section will explain common situations that may arise and will help come up with a resolution to get the dryer back to operation.

## Diagnosing a Dryer Shutdown

The safety of your dryer is in the hands of the safety circuit. These are a series of components that are tied together. If one fails the system will shutdown insuring the safety of your grain dryer.

### Safety Circuit Overview

The contacts for incoming hot and neutral are found in the High Voltage cabinet.

The 120 volt input power to the dryer circuit for dryer controls comes from the bottom side of the transformer and runs to the top of the 8 amp mini-breaker. This breaker should be turned off and the voltage should be checked before turning the mini-breaker on. If the voltage reads anything outside of 125-volts, the supply voltage needs to be checked before powering on the mini-breaker.

Next to the mini breaker is a neutral block, which feeds all neutrals throughout the entire dryer. This neutral is connected to the neutral from the secondary side of the transformer that is standard equipment.

The incoming neutral line is connected to **TB5** (white wire) and the hot line is on **TB33** (after circuit breaker). The incoming 120-volt supply is an 8 amp mini-breaker.

The Safety Circuit can be viewed on page 4 and 5 of the electrical schematics. Page 4 is the Dryer Control or Fault Control portion of the Safety Circuit while page 5 of the electrical schematics contains the Dryer Safety, or Human Safety portion of the Safety Circuit. Components associated with the Dryer Control, or Fault Control portion of the Safety Circuit include the Fan Motor Overloads, High Limit Switches Linear Limits (if equipped) and Gas Pressure Switches for export model dryers. The components associated with the Dryer Safety, or Human Safety portion of the Safety Circuit are the E-Stops, Safety Relay and Plenum Door Switches for export dryers.

There are two ways to troubleshoot the Safety Circuit. One is through the Safety Circuit page of the Pinnacle 20|20 control while the other involves use of a voltmeter.

### Diagnosing Safety Circuit Via HMI

Before diagnosing the Safety Circuit, it is recommended to have a good understanding of the Pinnacle 20|20 Control. The Pinnacle 20|20 Control features a tab on the home page titled Troubleshooting. Pressing this tab populates different options. One of these options is the Safety Circuit tab. Pressing the Safety Circuit tab will bring up a page that visually illustrates the Safety Circuit and all associated components. To troubleshoot the disruption of the Safety Circuit, look for the component on the page that has a grayed out globe next to it as opposed to a green globe. Green globes indicate that the component and that particular part of the Safety Circuit is good. A grayed out globe indicates that the break in the Safety Circuit is associated with that particular component. One thing to note is that the High Limits and Motor Overloads are wired



in series respectively. Meaning, if one of the High Limits or Motor Overloads are tripped, all the High Limits or Motor Overloads proceeding the tripped one will appear on the Safety Circuit screen tripped as well. So the first High Limit or Motor Overload that appears with the grayed out globe should be addressed first as it is very likely that once addressed, all that follow may be good as well. For more information on diagnosing the Safety Circuit via the HMI, see the Pinnacle 20|20 controls manual.

### Diagnosing Safety Circuit With a Voltmeter

The Safety Circuit can also be diagnosed by using a DC voltmeter and the dryer schematic. Using the schematic as a guide, use the voltmeter to look for 24 vdc at terminals in the Low Voltage Cabinet. Be sure the Voltmeter is first set to read DC Voltage which is depicted with a straight line next to the V as opposed to a wavy line which depicts AC voltage. Take the black lead of the Voltmeter and place it in Terminal 320 (TB320). Next, move the red lead of the voltmeter to the first terminal of the Safety Circuit (TB341), followed in order by TB401 as shown below until 24 Volts no longer appears and 0 Volts measures on the Voltmeter instead.

TB341	Beginning of the safety circuit after circuit breaker #341.
TB401	Fan protector #1
TB402	Fan protector #2
TB403	Fan protector #3
TB404	Fan protector #4
TB405	Fan protector #5
TB406	Fan protector #6
TB407	Fan protector #7
TB408	Fan protector #8

Note: The dryer will only have the number of fan protector terminals as the dryer has fans.

TB421	High limit #1
TB422	High limit #2
TB423	High limit #3
TB424	High limit #4
TB425	High limit #5
TB426	High limit #6
TB427	High limit #7
TB428	High limit #8

Note: The dryer will only have the number of high limits as the dryer has burners.

If there is 24 vdc at terminal #460, the safety circuit is complete.

If the dryer is an export model dryer, the following items will be included in the Safety Circuit.

TB451	High gas pressure switch #1
TB452	High gas pressure switch #2
TB453	High gas pressure switch #3
TB454	High gas pressure switch #4
TB455	High gas pressure switch #5
TB456	High gas pressure switch #6
TB457	High gas pressure switch #7
TB458	High gas pressure switch #8

Note: The dryer will only have the number of high gas pressure switches as the dryer has burners.



Although the following items are not in series with the previously mentioned items, tripping any of these items will disengage the safety circuit and produce a red warning screen.

All dryers have “E-Stops” and have the option of a “Customer E-Stop” that if tripped, will disengage the safety circuit.

To check, visually inspect if any of these red E-Stop buttons are depressed:

Remote cabinet

Low voltage cabinet

High voltage cabinet

Customer E-Stop (Optional, provided by customer)

If the dryer is an export model, the following items, if tripped will disengage the safety circuit.

TB491	Plenum door #1 safety switch
TB492	Plenum door #2 safety switch
TB493	Plenum door #3 safety switch
TB494	Plenum door #4 safety switch
TB495	Plenum door #5 safety switch
TB496	Plenum door #6 safety switch
TB497	Plenum door #7 safety switch
TB498	Plenum door #8 safety switch





# Safety Circuit Schematic

The second part of the safety circuit below will help diagnose a dryer shut down. This is the Dryer Safety or Human Safety portion of the Safety Circuit. See page 5 of the electrical schematics to see this portion of the safety circuit that matches exactly to your particular dryer.

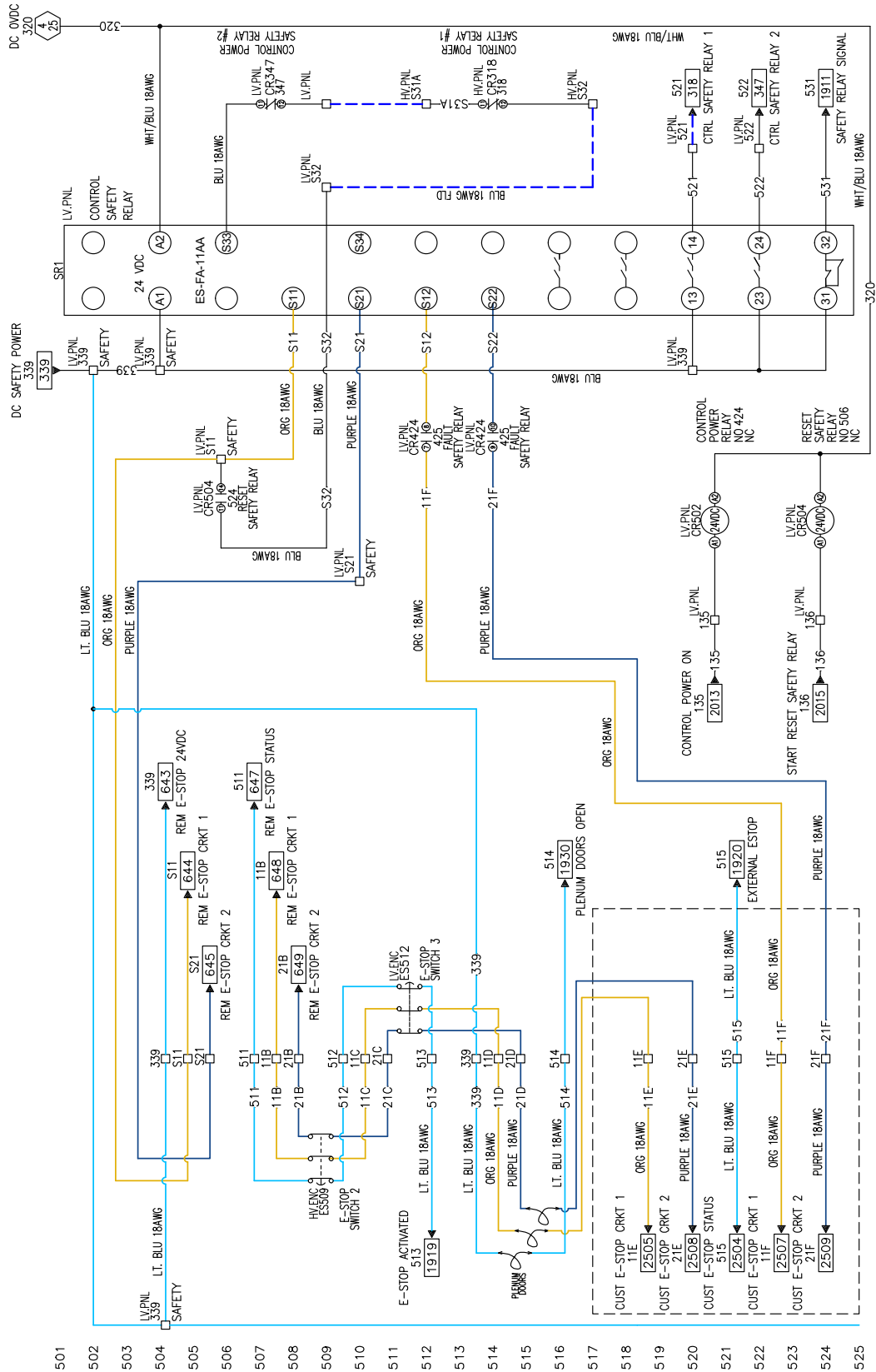



## Customer Interface

Customer connections are for remote equipment, and are used to interface the grain dryer with fill and takeaway equipment. The grain dryer does not supply power for these interfaces. An auxiliary power source should be used to power customer equipment.

### Fill Customer Connections

- **F1-F2** = Fill equipment status
- **F3-F4** = Fill 2 dry contacts
- **F5-F6** = Fill 1 dry contacts

**F1-F2.** **F1** and **F2** is a signal to the PLC confirming that customer fill equipment is not in a fault condition and can be started.

**F3-F4.** **F3** and **F4** are a dry set of, normally open contacts that close when the dryer fill cycle begins. When this closes (when the call for grain happens), the dryer will start all the customer's equipment that is associated with Fill 2. It is the last of the fill equipment to stop.

**F5-F6.** **F5** and **F6** are a dry set of normally open contacts that close when the dryer fill cycle begins. When this closes (after the delay following the call for grain expires), the dryer will start all the customer's equipment that is associated with Fill 1. Fill 1 equipment will stop after the call for grain but before fill 2 equipment stops.

### Takeaway Customer Connections

- **T1-T2** = Takeaway equipment status
- **T3-T4** = Takeaway 2 dry contacts
- **T5-T6** = Takeaway 1 dry contacts

**T1-T2.** **T1** and **T2** is a signal to the PLC confirming that customer takeaway equipment is not in a fault condition and can be started.

**T3-T4.** **T3** and **T4** are a dry set of normally open contacts that close when the dryer Takeaway START button is pressed. This starts all customer's equipment associated with Takeaway 2 immediately after the button is pressed. Equipment tied to this signal will stop after the Takeaway STOP button is pressed and the Takeaway 2 Stop Delay has elapsed.

**T5-T6.** **T5** and **T6** are a dry set of normally open contacts that close when the dryer Takeaway START button is pressed and the Takeaway 1 Start Delay has elapsed. This starts all customer's equipment associated with Takeaway 1. Equipment tied to this signal will stop immediately after the Takeaway STOP button is pressed.

### E-Stop Customer Connections

- **E1-E2** = Customer E-Stop status
- **E3-E4** = Safety Relay Circuit 1
- **E5-E6** = Safety Relay Circuit 2

**E1-E2.** **E1** and **E2** is a signal to the PLC confirming that all customer equipment included in the safety circuit are satisfied.

**E3-E4.** **E3** and **E4** breaks the 24V signal and initiates an emergency shutdown of the dryer.

**E5-E6.** **E5** and **E6** breaks the 24V signal and initiates an emergency shutdown of the dryer.

**Note:** *Breaking either E3/E4 or E5/E6 will result in the same emergency shutdown of the dryer.*



## Variable Frequency Drive (VFD)

In the case an error occurs on the variable frequency drives (VFD's) listed below are the display faults that will show up on the main display of the drive.

### Fault Code Description

Described below is the fault code and a description of the fault. This will also give an action to help resolve the issue.

CODE	FAULT	CAUSE	WHAT TO DO
0001	OVERCURRENT (2310)	Output current has exceeded trip level.	
		Sudden load change or stall.	Check motor load and mechanics.
		Insufficient acceleration time.	Check acceleration time ( <a href="#">2202</a> and <a href="#">2205</a> ). Check the possibility of using vector control.
		Incorrect motor data.	Check that motor data (Group 99) is equal to motor rating plate values. If using vector control, perform ID run ( <a href="#">9910</a> ).
		Motor and/or drive is too small for the application.	Check sizing.
		Damaged motor cables, damaged motor or wrong motor connection (star/delta).	Check motor, motor cable and connections (including phasing).
		Internal fault of the drive. Drive gives an overcurrent fault after start command even when the motor is not connected (use scalar control in this trial).	Replace the drive.
0002	DC OVERVOLT (3210)	Excessive intermediate circuit DC voltage. DC overvoltage trip limit is 420 V for 200 V drives and 840 V for 400 V drives.	
		Supply voltage is too high or noisy. Static or transient overvoltage in the input power supply.	Check input voltage level and check power line for static or transient overvoltage
		If the drive is used in a floating network, DC overvoltage fault may appear	In a floating network, remove the EMC screw from the drive.



CODE	FAULT	CAUSE	WHAT TO DO
		<p>If the overvoltage fault appears during deceleration, possible causes are:</p> <ul style="list-style-type: none"> <li>• Overvoltage controller disabled.</li> <li>• Deceleration time is too short.</li> <li>• Faulty or undersized braking chopper.</li> </ul>	<ul style="list-style-type: none"> <li>• Check that overvoltage controller is on (parameter <a href="#">2005 OVERVOLT CTRL</a>).</li> <li>• Check deceleration time (<a href="#">2203</a>, <a href="#">2206</a>).</li> <li>• Check brake chopper and resistor (if used). DC overvoltage control must be deactivated when brake chopper and resistor is used (parameter <a href="#">2005 OVERVOLT CTRL</a>). Retrofit drive with brake chopper and brake resistor.</li> </ul>
0003	DEV OVERTEMP (4210)	Drive IGBT temperature is excessive. The fault trip limit depends on the drive type and size.	
		Ambient temperature is too high.	Check ambient conditions.
		Airflow though the inverter is not free.	Check air flow and free space above and below the drive.
		Fan is not working properly	Check fan operation.
		Overloading of the drive.	50% overload is allowed for one minute in ten minutes. If higher switching frequency (parameter <a href="#">2606</a> ) is used.
0004	SHORT CIRC (2340)	Short-circuit in motor cable(s) or motor.	
		Damaged motor or motor cable.	Check motor and cable insulation. Check motor winding
		Internal fault of the drive. Drive gives an overcurrent fault after start command even when the motor is not connected (use scalar control in this trial).	Replace the drive.
0006	DC UNDERVOLT (3220)	Intermediate circuit DC voltage is not sufficient.	Check input power supply and fuses.
		Undervoltage controller disabled.	Check that undervoltage controller is on (parameter <a href="#">2006 UNDERVOLT CTRL</a> ).

CODE	FAULT	CAUSE	WHAT TO DO
		Missing input power line phase.	Measure the input and DC voltage during start, stop and running by using a multimeter or check parameter <i>0107 DC BUS VOLTAGE</i> .
		Blown fuse	Check the condition of input fuses.
		Rectifier bridge internal fault.	Replace the drive.
0007	AI1 LOSS (8110)  (programmable fault function <i>3001, 3021</i> )	Analog input AI1 signal has fallen below limit defined by parameter <i>3021 AI1 FAULT LIMIT</i> .	
		Analog input signal is weak or does not exist.	Check the source and wire connections of the analog input.
		Analog input signal is lower than fault limit.	Check parameters <i>3001 AI&lt;MIN FUNCTION</i> and <i>3021 AI1 FAULT LIMIT</i> .
0008	AI2 LOSS (8110)  (programmable fault function <i>3001, 3022</i> )	Analog input AI2 signal has fallen below limit defined by parameter <i>3022 AI2 FAULT LIMIT</i> .	.
		Analog input signal is weak or does not exist.	Check the source and wire connections of analog input.
		Analog input signal is lower than fault limit.	Check parameters <i>3001 AI&lt;MIN FUNCTION</i> and <i>3021 AI1 FAULT LIMIT</i> .



CODE	FAULT	CAUSE	WHAT TO DO
0009	MOT OVERTEMP (4310)  (programmable fault function <a href="#">3005...3009</a> / <a href="#">3504</a> )	Motor temperature estimation is too high.	
		Excessive load or insufficient motor power	Check motor ratings, load and cooling.
		Incorrect start-up data.	Check start-up data. Check fault function parameters <a href="#">3005...3009</a> . Minimize IR compensation to avoid heating (parameter <a href="#">2603 IR COMP VOLT</a> ). Check frequency of the motor (low running frequency of motor with high input current can cause this fault). Let the motor cool down. The necessary cooling time period depends on the value of parameter <a href="#">3006 MOT THERM TIME</a> . Motor temperature estimation is counted down only when the drive is powered on.
		Measured motor temperature has exceeded the fault limit set by parameter <a href="#">3504 FAULT LIMIT</a> .	Check value of fault limit. Check that actual number of sensors corresponds to value set by parameter <a href="#">3501 SENSOR TYPE</a> . Let the motor cool down. Ensure proper motor cooling: Check the cooling fan, clean cooling surfaces, etc.
0010	PANEL LOSS (5300)  (programmable fault function <a href="#">3002</a> )	Control panel selected as active control location for drive has ceased communicating.	Check panel connection. Check fault function parameters. Check parameter <a href="#">3002 PANEL COMM ERR</a> . Check control panel connector. Refit control panel in mounting platform. If the drive is in external control mode (REM) and is set to accept start/stop, direction commands or references through control panel: Check group <a href="#">10 START/STOP/DIR</a> and <a href="#">11 REFERENCE SELECT</a> settings.
0011	ID RUN FAIL (FF84)	Motor ID run is not completed successfully.	Check motor connection. Check start-up data (group <a href="#">99 START-UP DATA</a> ). Check maximum speed (parameter <a href="#">2002</a> ). It should be at least 80% of motor nominal speed (parameter <a href="#">9908</a> ).



CODE	FAULT	CAUSE	WHAT TO DO
0012	MOTOR STALL (7121)  (programmable fault function <a href="#">3010...3012</a> )	Motor is operating in stall region due to eg excessive load or insufficient motor power.	Check motor load and drive ratings. Check fault function parameters <a href="#">3010...3012</a> .
0014	EXT FAULT 1 (9000)  (programmable fault function <a href="#">3003</a> )	External fault 1	Check external devices for faults. Check parameter <a href="#">3003 EXTERNAL FAULT 1</a> setting.
0015	EXT FAULT 2 (9001)  (programmable fault function <a href="#">3004</a> )	External fault 2	Check external devices for faults. Check parameter <a href="#">3004 EXTERNAL FAULT 2</a> setting.
0016	EARTH FAULT (2330)  (programmable fault function <a href="#">3017</a> )	Drive has detected earth (ground) fault in motor or motor cable.	Check motor. Check motor cable. Motor cable length must not exceed maximum specifications.  <b>Note:</b> Disabling earth fault (ground fault) may damage drive.
		Drive internal fault.	Internal short-circuit may cause earth fault indication. This has happened if fault <a href="#">0001</a> appears after disabling the earth fault. Replace the drive.
0017	UNDERLOAD (FF6A)  (programmable fault function <a href="#">3013...3015</a> )	Motor load is too low due to eg release mechanism in driven equipment.	Check for problem in driven equipment. Check fault function parameters <a href="#">3010...3012</a> . Check motor power against drive power.
0018	THERM FAIL (5210)	Temperature of the drive exceeds the operating level of the thermistor.	Check that the ambient temperature is not too low.
		Drive internal fault. Thermistor used for drive internal temperature measurement is open or short-circuited	Replace the drive.
0021	CURR MEAS (2211)	Drive internal fault. Current measurement is out of range.	Replace the drive.



CODE	FAULT	CAUSE	WHAT TO DO
0022	SUPPLY PHASE (3130)  (programmable fault function <a href="#">3016</a> )	Intermediate circuit DC voltage is oscillating due to missing input power line phase or blown fuse.	Check input power line fuses and installation. Check for input power supply imbalance. Check the load.
		Trip occurs when DC voltage ripple exceeds 14% of nominal DC voltage.	Check fault function parameter <a href="#">2619 DC STABILIZER</a> .
0023	ENCODER ERR (7301)  <a href="#">5003</a> )	Communication fault between pulse encoder and pulse encoder interface module or between module and drive.	Check pulse encoder and its wiring, pulse encoder interface module and its wiring and parameter group <a href="#">50 ENCODER</a> settings.
0024	OVERSPEED (7310) <a href="#">0306</a> bit 7	Motor is turning faster than 120% of the highest allowed speed due to incorrectly set minimum/maximum speed, insufficient braking torque or changes in load when using torque reference. Operating range limits are set by parameters <a href="#">2001 MINIMUM SPEED</a> and <a href="#">2002 MAXIMUM SPEED</a> (in vector control) or <a href="#">2007 MINIMUM FREQ</a> and <a href="#">2008 MAXIMUM FREQ</a> (in scalar control).	Check minimum/maximum frequency settings (parameters <a href="#">2001 MINIMUM SPEED</a> and <a href="#">2002 MAXIMUM SPEED</a> ). Check adequacy of motor braking torque. Check applicability of torque control. Check need for brake chopper and resistor(s).
0027	CONFIG FILE (630F)	Internal configuration file error	Replace the drive.
0028	SERIAL 1 ERR (7510)  (programmable fault function <a href="#">3018</a> , <a href="#">3019</a> )	Fieldbus communication break	Check status of fieldbus communication.  Check fault function parameter <a href="#">3018 COMM FAULT FUNC</a> and <a href="#">3019 COMM FAULT TIME</a> settings. Check connections and/or noise on the line. Check if master can communicate.
0029	EFB CON FILE (6306)	Configuration file reading error	Error in reading the configuration files of the embedded fieldbus. See fieldbus user's manual.



CODE	FAULT	CAUSE	WHAT TO DO
0030	FORCE TRIP (FF90)	Trip command received from fieldbus	Fault trip was caused by fieldbus. See fieldbus user's manual.
0034	MOTOR PHASE (FF56)	Motor circuit fault due to missing motor phase or motor thermistor relay (used in motor temperature measurement) fault.	Check motor and motor cable. Check motor thermistor relay (if used).
0035	OUTP WIRING (FF95)  (programmable fault function <a href="#">3023</a> )	Incorrect input power and motor cable connection (ie input power cable is connected to drive motor connection).	Possible power wiring error detected. Check that input power connections are not connected to drive output.  Fault can be declared if input power is delta grounded system and motor cable capacitance is large. This fault can be disabled by parameter <a href="#">3023 WIRING FAULT</a> .
0036	INCOMPATIBLE SW (630F)	Loaded software is not compatible.	Loaded software is not compatible with the drive. Contact your local ABB representative.
0037	CB OVERTEMP (4110)	Drive control board overheated. Fault trip limit is 95 °C.	Check for excessive ambient temperature. Check for fan failure. Check for obstructions in air flow. Check the dimensioning and cooling of cabinet.
0044	SAFE TORQUE OFF (FFA0)	STO (Safe torque off) requested and it functions correctly.  Parameter <a href="#">3025 STO OPERATION</a> is set to react with fault.	If this was not expected reaction to safety circuit interruption, check cabling of safety circuit connected to STO terminals X1C.  If different reaction is required, change value of parameter <a href="#">3025 STO OPERATION</a> .  Reset fault before starting.
0045	STO1 LOST (FFA1)	STO (Safe torque off) input channel 1 has not de-energized, but channel 2 has. Opening contacts on channel 1 might have been damaged or there is a short-circuit.	Check STO circuit cabling and opening of contacts in STO circuit.
0046	STO2 LOST (FFA2)	STO (Safe torque off) input channel 2 has not de-energized, but channel 1 has. Opening contacts on channel 2 might have been damaged or there is a short-circuit.	Check STO circuit cabling and opening of contacts in STO circuit.





CODE	FAULT	CAUSE	WHAT TO DO
0101	SERF CORRUPT (FF55)	Drive internal error.	Replace the drive.
0103	SERF MACRO (FF55)		
0201	DSP T1 OVERLOAD (6100)	Drive internal error.	If fieldbus is in use, check the communication, settings and contacts. Write down fault code and contact your local ABB representative.
0202	DSP T2 OVERLOAD (6100)		
0203	DSP T3 OVERLOAD (6100)		
0204	DSP STACK ERROR (6100)		
0206	CB ID ERROR (5000)	Drive internal error.	Replace the drive.
1000	PAR HZRPM (6320)	Incorrect speed/frequency limit parameter setting	<p>Check parameter settings. Check that following applies:</p> <ul style="list-style-type: none"> <li>• <i>2001 MINIMUM SPEED &lt; 2002 MAXIMUM SPEED</i></li> <li>• <i>2007 MINIMUM FREQ &lt; 2008 MAXIMUM FREQ</i></li> <li>• <i>2001 MINIMUM SPEED / 9908 MOTOR NOM SPEED, 2002 MAXIMUM SPEED / 9908 MOTOR NOM SPEED, 2007 MINIMUM FREQ / 9907 MOTOR NOM FREQ and 2008 MAXIMUM FREQ / 9907 MOTOR NOM FREQ</i> are within range.</li> </ul>
1003	PAR AI SCALE (6320)	Incorrect analog input AI signal scaling	<p>Check parameter group <b>13 ANALOG INPUTS</b> settings. Check that following applies:</p> <ul style="list-style-type: none"> <li>• <i>1301 MINIMUM AI1 &lt; 1302 MAXIMUM AI1</i></li> <li>• <i>1304 MINIMUM AI2 &lt; 1305 MAXIMUM AI2.</i></li> </ul>

CODE	FAULT	CAUSE	WHAT TO DO
1004	PAR AO SCALE (6320)	Incorrect analog output AO signal scaling	Check parameter group <b>15 ANALOG OUTPUTS</b> settings. Check that following applies: <ul style="list-style-type: none"> <li>• <b>1504 MINIMUM AO1</b> &lt; <b>1505 MAXIMUM AO1</b>.</li> </ul>
1005	PAR PCU 2 (6320)	Incorrect motor nominal power setting	Check parameter <b>9909 MOTOR NOM POWER</b> setting. Following must apply: <ul style="list-style-type: none"> <li>• <math>1.1 &lt; (9906 \text{ MOTOR NOM CURR} \cdot 9905 \text{ MOTOR NOM VOLT} \cdot 1.73 / P_N) &lt; 3.0</math></li> </ul> Where $P_N = 1000 \cdot 9909 \text{ MOTOR NOM POWER}$ (if units are in kW) or $P_N = 746 \cdot 9909 \text{ MOTOR NOM POWER}$ (if units are in hp).
1006	PAR EXT RO (6320)  (programmable fault function <b>3027</b> )	Incorrect relay output extension parameters	Check parameter settings. Check that following applies: <ul style="list-style-type: none"> <li>• Output relay module MREL-01 is connected to drive. See parameter <b>0181 EXT MODULE STATUS</b>.</li> <li>• <b>1402 RELAY OUTPUT 2</b>, <b>1403 RELAY OUTPUT 3</b> and <b>1410 RELAY OUTPUT 4</b> have non-zero values.</li> </ul> See <i>MREL-01 output relay module user's manual</i> (3AUA0000035974 [English]).
1007	PAR FBUSMISS (6320)	Fieldbus control has not been activated.	Check fieldbus parameter settings.
1009	PAR PCU 1 (6320)	Incorrect motor nominal speed/frequency setting	Check parameter settings. Following must apply for induction motor: <ul style="list-style-type: none"> <li>• <math>1 &lt; (60 \cdot 9907 \text{ MOTOR NOM FREQ} / 9908 \text{ MOTOR NOM SPEED}) &lt; 16</math></li> <li>• <math>0.8 &lt; 9908 \text{ MOTOR NOM SPEED} / (120 \cdot 9907 \text{ MOTOR NOM FREQ} / \text{Motor poles}) &lt; 0.992</math></li> </ul> Following must apply for permanent magnet synchronous motor: <ul style="list-style-type: none"> <li>• <math>9908 \text{ MOTOR NOM SPEED} / (120 \cdot 9907 \text{ MOTOR NOM FREQ} / \text{Motor poles}) = 1.0</math></li> </ul>
1015	PAR USER U/F (6320)	Incorrect voltage to frequency (U/f) ratio voltage setting.	Check parameter <b>2610 USER DEFINED U1 ... 2617 USER DEFINED F4</b> settings.



CODE	FAULT	CAUSE	WHAT TO DO
1017	PAR SETUP 1 (6320)	Only two of the following can be used simultaneously: MTAC-01 pulse encoder interface module, frequency input signal or frequency output signal.	Disable frequency output, frequency input or encoder: <ul style="list-style-type: none"> <li>• change transistor output to digital mode (value of parameter <i>1804 TO MODE</i> = 0 [<i>DIGITAL</i>]), or</li> <li>• change frequency input selection to other value in parameter groups <i>11 REFERENCE SELECT</i>, <i>40 PROCESS PID SET 1</i>, <i>41 PROCESS PID SET 2</i> and <i>42 EXT / TRIM PID</i>, or</li> <li>• disable (parameter <i>5002 ENCODER ENABLE</i>) and remove MTAC-01 pulse encoder interface module.</li> </ul>

## Common Diagnostic Issues

Listed below are common issues that may occur while operating your Mathews Company grain dryer.

**Problem:**

Dryer will not reach operating temperature, or it reaches it slowly.

**Possible Cause/Solution:**

1. Low gas pressure. Increases gas pressure on the main gas regulatory.
2. Check for water in the gas train by opening the drain valve.
3. Make sure the dryer is completely full of grain by entering the heat plenum chamber and looking for daylight in one of the grain columns.
4. Make sure that the gas butterfly valve is being driven wide open by the modutrol motor. If not, check the motor or motor linkage. Also check to make sure that there is not a block within the gas piping. There should be 10 pounds on the primary regulator and 1 to 2 pounds on the secondary.
5. Ensure the max % valve opening on the Pinnacle 20|20 Control is not set too low.

**Problem:**

Blower motor(s) will not start.

**Possible Cause/Solution:**

1. Check that the fan circuit breaker has not tripped and that the fan button is pressed on the HMI.
2. Verify closing of the fan motor contactor. Check voltage on the load side of the contactor.
3. Inspect the contactor for defective contact or a burned out coil.
4. Inspect connections, and check voltage applied to the motor leads to determine if the motor is defective.

If the motor starts slowly, check for low voltage during starting due to excessive voltage drop in power supply wiring.

**Problem:**

Burner will not fire.

**Possible Cause/Solution:**

1. Check gas supply for possible obstruction or closed valves. Refill tank; replace or repair parts as required.
2. Inspect gas solenoid valves for defective coils or improper wiring. Replace the valve or coil if the valve will not open with proper voltage applied (115 volts).
3. Ensure initial % valve opening is properly set.



**Problem:**

Burner will not fire, but gauge shows gas pressure.

**Possible Cause/Solution:**

1. Check that the igniter is properly gapped and has a strong spark.
2. Inspect the porcelain and electrodes for damage or cracking. Clean or replace if necessary.
3. Machine does not have chassis ground.
4. Check solenoids for proper operation.
5. Ensure initial % valve opening is properly set.

**Problem:**

Uneven drying, some kernels appear brown while others are under dried. Uneven heat exiting from dryer columns.

**Possible Cause/Solution:**

1. Check plenum temperature setting. Some varieties of grain are more sensitive to higher operating temperatures. It may be necessary to lower the plenum operating temperature to accommodate this.

**Problem:**

Grain is not moving through columns.

**Possible Cause/Solution:**

1. Check the dryer for fine material buildup inside the columns.
2. Avoid leaving the dryer columns full for long periods at a time (2-3 days) while not operating the dryer, or during rainy weather.
3. Empty the dryer and clean regularly. Do not allow fine material to gather in the plenum chamber.

**Problem:**

Difficult lighting the burner

**Possible Cause/Solution:**

1. Fan must be ON to achieve air pressure light.
2. Ignition button is pressed on HMI. This applies 24 VAC at L1 (0 volts at L2 Neutral) of the ignition board.
3. After pre-purge time, the ignition board should power out 24 VAC at V1 (V2 neutral) for a trial ignition period to eliminate the gas valve light and gas valve light. The ignition trial time is 7 seconds. If the trial is not successful, voltage outputs stop.
4. Check the gas solenoid operation by listening for a click/snap or feeling the vibration as they open. If the solenoid doesn't open, check the wiring and coil for damage, bad connections, etc.
5. Check the spark plug (igniter) for spark. Check the high voltage wire for damage, good connections.
6. Replace the ignition board.
7. Ensure initial % valve opening is properly set.

**Problem:**

The burner lights but does not stay on.

**Possible Cause/Solution:**

(NOTE: This is most likely due to the flame sensing)

1. Ensure flame sense probe is located in the flame.
2. Inspect the sense wire for damage and for loose or wet connections.
3. Check that sense wire is routed separately from the high voltage ignition wire.
4. Check the ignition board (B.GND) is grounded separately from all other connections. Sharing a ground connection can cause problems.
5. Clean sense probe with fine steel wool.

Burner may have to be grounded at the burner body directly to the burner housing











