

Iron Horse Quality

Printed in the United States of America

\$3.00



Model 670, 690 & 970
(EM and EMS)
**Continuous Flow
Grain Dryers**
(Starting w/Serial No. 52698)

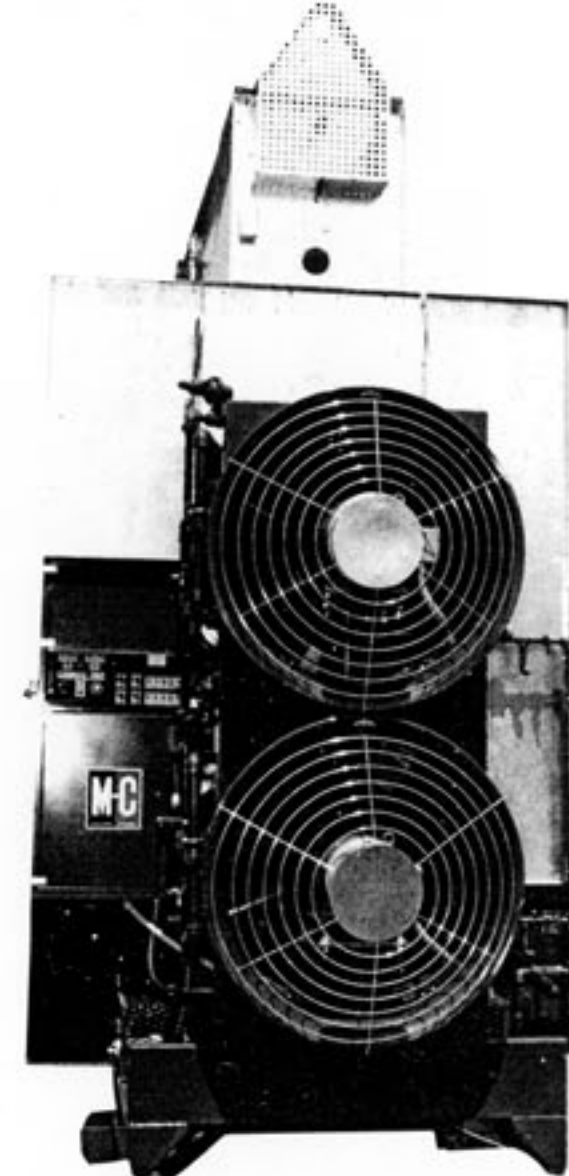



OPERATOR'S MANUAL

Form No. D308, September 1993

Mathews Company / 500 Industrial Ave., Crystal Lake, IL 60012, U.S.A.
815/459-2210 FAX 815/459-5889

Electrical Components

Starting with S/N 46799 - The reference numbers in this list are shown in the  or  symbols on the wiring diagrams.

Ref.	Part No.	Description	Ref.	Part No.	Description
1	120 6800	Mercury Switch	19	124 6890	.1 to 8 Minute Adj. Timer w/Brkt.
2	121 6849	Air Pressure Switch		127 6802	60 Second Timer w/Brkt.
3	124 6934	High Limit Switch		124 6831	10 Second Timer w/Brkt.
4	121 6925	115V Ignition Board (Incl. Ref. 8)	20	124 6841	Light Bulb Socket
5	123 6887	Differential Air Pressure Switch (Canadian Dryers Only)	21	124 6850	25W Rough Service Bulb
6	Terminal Block			124 6842	50W Rough Service Bulb
	124 6928	12 Position	22	021 6810	Relay Socket
	124 6929	3 Position	23	021 6809	Relay
7	128 6995	Electrode	24	021 6816	Timer Socket
8	122 6814	Ignition Reset (0.1 Amp.)	25	021 6815	60 Minute Adjustable Timer
9	115V LP Gas Solenoid Valves		29	124 6874	SCR Board (Dart)
	125 7082	1/2" Solenoid Valve in LP Liquid Line (All USA & Canadian 370 thru 1195)	32	124 6837	1/3HP DC Motor
	121 7002	3/4" Solenoid Valve in Gas Manifold (All USA & Canadian 370 & 665, & Canadian 675 thru 3175)	33	128 6957	Splitter Block
	128 7001	1 1/2" Solenoid Valve in Gas Manifold (All USA & Canadian 670, 690 & 970, & USA 675 thru 3175)	35	124 6872	Flame Sensing Probe
	115V Natural Gas Solenoid Valves		36	127 6812	Resistor (10W - 3K OHM)
	128 7001	1 1/2" Solenoid Valve in Gas Manifold (All USA & Canadian 370 thru 3175)	39	128 6992	Bin Level Indicator (Inside Mt.)
			44	121 6956	Linear Limit Control (138")
				128 6850	Linear Limit Control (92")
			45	123 6854	Light Fixture Cpt.
				123 6898	Red Glass Globe
				125 6823	100W Rough Service Bulb
			46	123 6868	Horn (Alarm Buzzer)
			47	---	Magnetic Starters (See Magnetic Starters Table)
			48	127 6855	Transformer-208V (750VA)
				127 6829	Transformer-230/460/575V (750VA)
			49	124 1089	10 Turn Potentiometer w/Wire
			50	124 6892	Multi-Dial
			51	124 6893	Thermistor
			52	124 6939	Potentiometer
10	128 6967	10 Amp. Fuse (NON-10)	57	121 6805	10 Amp. GLH Fuse
11	128 6851	Fuse Holder	78	123 7027	Manual Reset Shut-Off Valve (1") 675-3175 LP Gas
12	128 6845	Stop Button (Red)		123 7028	Manual Reset Shut-Off Valve (2") 675-1195 Nat. Gas
13	128 6844	Start Button (Black)	82	128 7004	Canadian Low Pressure Interlock
14	124 6848	8 Amp. Circuit Breaker (SCR Drive)	83	124 6940	Moisture-Matic®II Board
15	121 6808	125V Indicator Lamp Ass'y	84	124 6936	DC Meter
	122 6810	125V Indicator Lamp	85	124 1081	Meter Resistor Ass'y
	122 6800	Indicator Lamp Lens (Clear)	86	124 6938	Fuse Holder
16	121 6815	SPST ON-OFF Toggle Switch	87	124 6937	1 Amp. Fuse
17	120 6827	Momentary Contact Toggle Switch			
18	121 6807	DPDT ON-OFF-ON Toggle Switch			

CONTENTS

	Page
Introduction	
To the Owner - Operator	3
Safety Precautions	3
Warranty Registration	3
Model and Serial Number Location	3
Capscrew Grade Identification	4
Metric (SI) Measurement Conversion Table	4
Dimensional Drawings	
Dryer	38 & 39
Dryer Base	37
Electrical and Gas Piping Entrance	37
Electrical Components	40
Wiring Diagrams	(see foldouts at the back of the manual)
Set-Up Instructions	
General	5
Canadian Requirements	5
Permanent Installation	5
Portable or Temporary Installation	5
Anchoring the Dryer	5
Hopper and Level Auger	6
Level Auger Motor	7
Hopper Installation	8
Level Auger Motor and Bin Switch Wiring	9
Fan Clearance	9
Filling Equipment (Customer Supplied)	9
Loading Augers and Take Away Equipment	9
Electric Power Supply	10
Gas Supply and Connections	10
Gas Consumption (BTU/Hr.)	11
Fan Rotation	11
Level and Unload Auger Rotation	12
Control Panel Lights, Switches and Controls	
Control Panel Lights	12
Control Panel Switches and Controls	13
Initial Start-Up Instructions	
General	14
Filling the Dryer	14
Air Pressure Switches	15
Starting the Burners	16
Setting Burner Operating Temperature	17
Operating Instructions	
Operation of the Discharge System	18
Switching from Manual to Automatic	19
Moisture Control Setting & Adjustments When in Automatic	20
Level Auger Operation	21

Continued on next page

Model 690 Dryer Dimension Chart

(All Dimensions Are In Inches)

NOTE: The grain receiving tube is a standard 10" tube. Inside dimensions of the unload auger discharge are 10 $\frac{5}{8}$ " x 16".

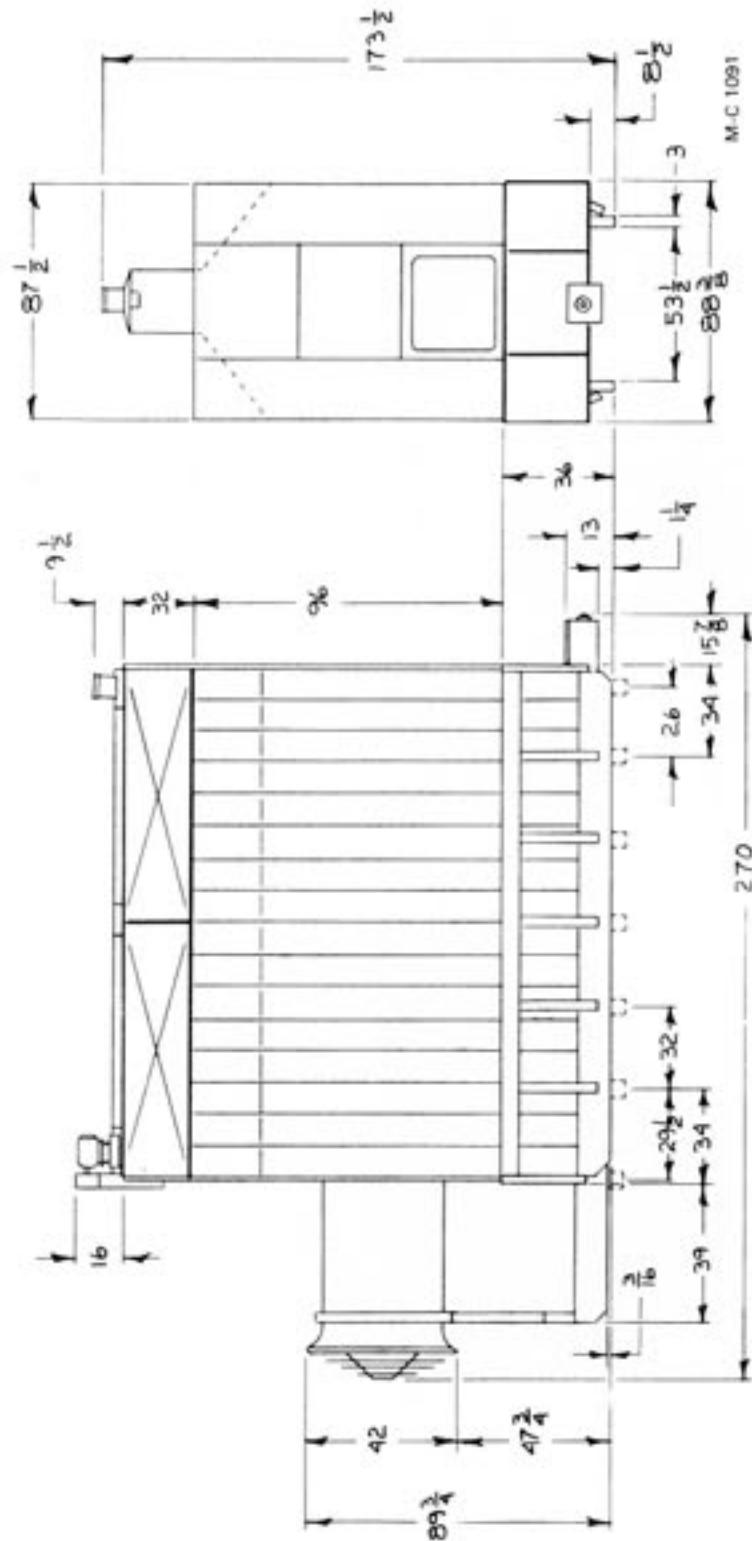

INTRODUCTION

To The Owner-Operator

This manual was prepared to provide owners and operator's of M-C Model 670, 690 and 970 Grain Dryers (starting with serial number 52698) with Operating Instructions and Maintenance Information that will enable them to keep their M-C Grain Dryer operating at peak efficiency.

Before operating your Grain Dryer read the Start-Up and Operating instructions. Check each item referred to and become familiar with the controls, adjustments and settings required to obtain efficient operation.

To keep the dryer operating at peak efficiency it is suggested that it be cleaned, lubricated, belt tension adjusted and the ignition system, level auger and unloading system be tested each year prior to the dryer season. Refer to "Pre-Season Check" in the Maintenance section. The pre-season check can be made when the dryer is empty. Any necessary repairs or adjustments can be made so that the dryer will be ready to operate before the drying season.

Safety Precautions



This symbol is used to call your attention to instructions concerning your personal safety. Be sure to observe and follow these instructions.

A safe operator is the best insurance against accidents. The precautions listed below must be observed at all times.

- Do not allow children or bystanders to be near the Grain Dryer or grain handling machinery while it is operating.
- Do not operate the Grain Dryer without all safety shields in place and secure.

NOTE: To provide clear illustrations some of the covers, guards and shields were removed.

Warranty Registration

It is important to send in your warranty registration card as soon as your new Grain Dryer is delivered. Not only does the card validate your grain dryer warranty, but it is also our way of knowing who has purchased M-C equipment so that we can keep in touch with you.

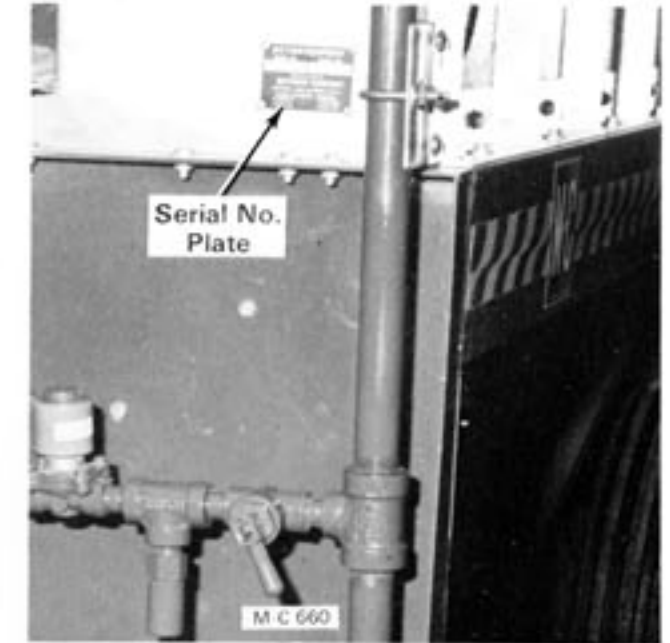

Figure A



Figure B

Model and Serial Number Location





The model and serial number of your Grain Dryer are stamped on a plate located on the left front end panel, see Figure A. On late production dryers, the plate is on the dryer front base panel just below the location shown in Figure A. For future reference record the model and serial number in the blank spaces in Figure B.

Capscrew Grade Identification

There are four grades of hex-head capscrews. Grade 1 and 2 are common capscrews, grade 5 and grade 8 are used when greater strength is required. Each grade can be identified by the marking on the head of the capscrew, see chart.

When servicing the Dryer and/or replacing capscrews, be sure to use the correct size and grade.

CAPSCREW GRADE IDENTIFICATION CHART

S.A.E. Grade	Description	Capscrew Head Marking*
1	WILL HAVE A PLAIN HEAD - NO RADIAL LINES	
2	Low or Medium Carbon Steel Not Heat Treated	
5	WILL HAVE 3 RADIAL LINES Quenched and Tempered Medium Carbon Steel	
8	WILL HAVE 6 RADIAL LINES Quenched and Tempered Special Carbon or Alloy Steel	

*The center marking identifies the capscrew manufacturer.

Metric (SI) Measurements

(English Units & Metric (SI) Equivalents)

Area

1 square inch = 6.4516 square centimeters
1 square foot = 0.0929 square meters
1 square yard = 0.8361 square meters
1 acre = 4047 square meters
1 acre = 0.4047 hectare

Force

1 pound (force) = 4.45 newtons

Length

1 inch = 25.4 millimeters
1 inch = 2.54 centimeters
1 foot = 304.8 millimeters
1 foot = 30.5 centimeters
1 foot = 0.305 meters
1 yard = 0.9144 meters
1 mile = 1.6093 kilometers

Mass

1 ounce = 28.35 grams
1 pound = 0.454 kilograms
1 ton = 907.1848 kilograms

Power

1 horsepower = 0.7457 kilowatts

Pressure

1 psi = 6.89 kilopascals
1 psi = 0.00689 megapascals
1 inch of mercury = 3.377 kilopascals

Temperature

1 degree Fahrenheit $(^{\circ}\text{F} - 32) \div 1.8 = ^{\circ}\text{Celsius}$

Torque

1 inch pound = 0.113 newton meters
1 foot pound = 1.356 newton meters

Velocity

1 mile per hour = 1.61 kilometers per hour

Volume

1 bushel = 35.24 liters
1 bushel = 0.0352 cubic meters
1 pint = 0.4731 liters
1 quart = 0.9464 liters
1 gallon = 3.7854 liters
1 cubic inch = 16.387 cubic centimeters
1 cubic foot = 0.0283 cubic meters
1 cubic yard = 0.7646 cubic meters

NOTE: The Mathews Company reserves the right to incorporate any changes in design without obligation to make these changes on units previously sold.

Electrical and Gas Piping Entrance

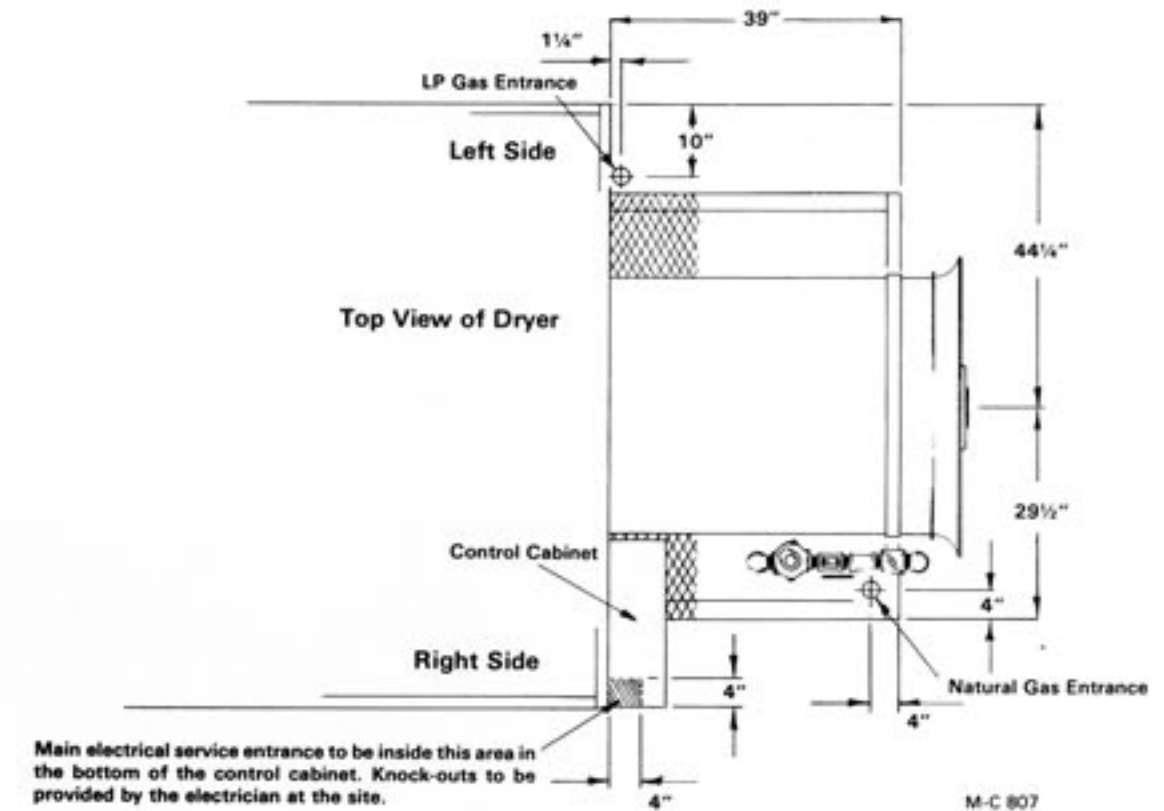

Dryer Base Dimensions

All Dimensions Are In Inches (Centimeters)

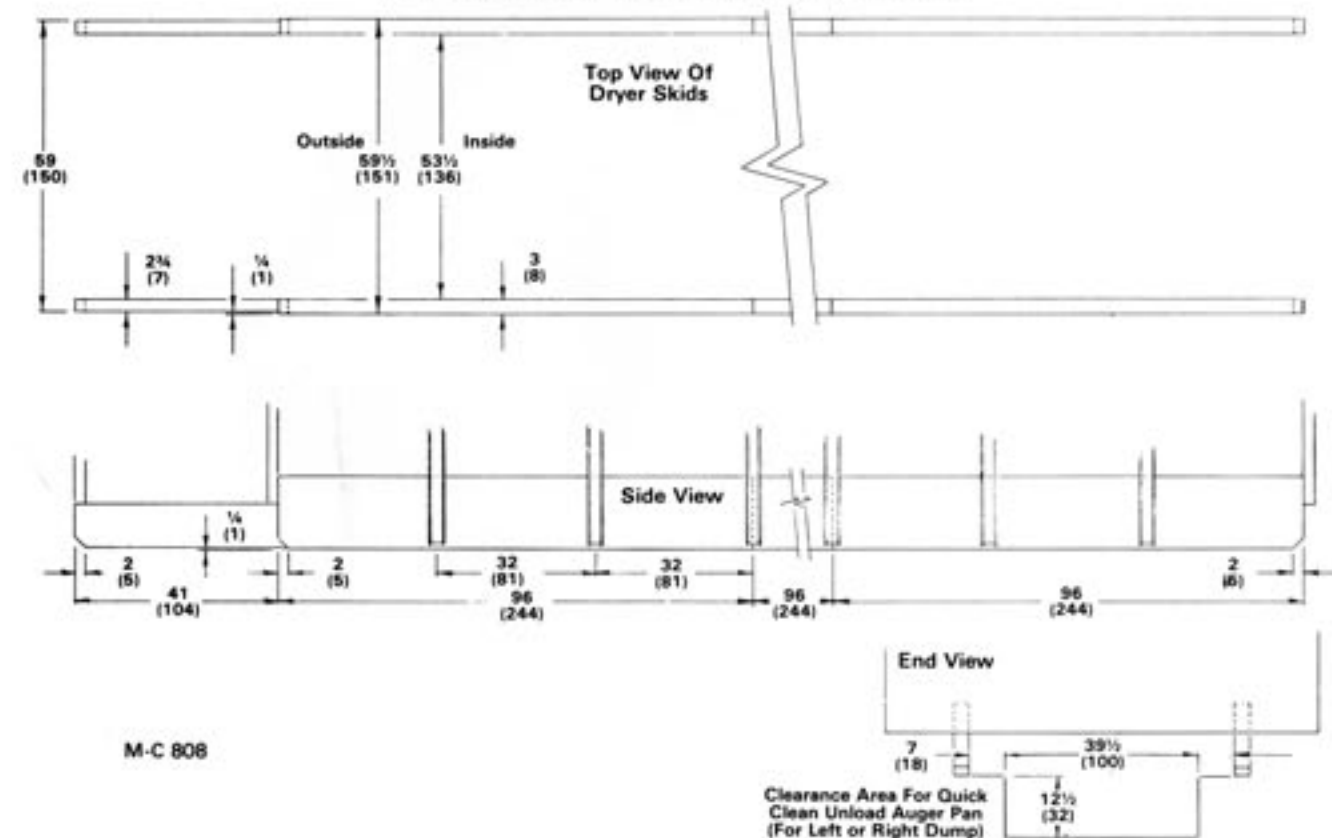

SET-UP INSTRUCTIONS

Problem	Possible Cause	Remedy
D. Repeated blowing of SCR board 10 amp. fuse	3. Motor shorted.	3. Replace or repair. Check for moisture in motor.
	4. Worn motor brushes.	4. Replace.
	5. Defective motor bearings.	5. Replace.
	6. Defective SCR board.	6. Replace.

MOISTURE-MATIC®II SYSTEM

Problem	Corrective Action																								
A. Plus (+) and minus (-) lights will not go off when calibrating Moisture-Matic®II control system.	1. Adjust the deadband trim pot on Moisture-Matic®II board (R-7) until both lights stay off when turning moisture control dial two spaces on the scale.																								
B. Metering rolls will not run.	<ol style="list-style-type: none"> 1. Discharge auger starter interlock bad. 2. Discharge auger not started. 3. Moisture-Matic®II 1 amp fuse is blown. 4. Moisture-Matic®II board inoperative. Check output voltage at (+) and (-) terminals on Moisture-Matic®II board. Voltage should be approximately 3 to 11 volts DC depending on the SCR speed control potentiometer setting in manual or moisture control setting in automatic. If no voltage, consult factory. 																								
C. Moisture-Matic®II does not control grain moisture.	<ol style="list-style-type: none"> 1. Moisture-Matic®II MANUAL OFF-AUTO switch not in AUTO position. 2. Bad thermistor. Check response with ohmmeter. <table border="1" style="margin-left: 20px;"> <thead> <tr> <th>Thermistor Temp.</th> <th>Thermistor Resistance</th> </tr> </thead> <tbody> <tr><td>30°F</td><td>29,000 OHMS</td></tr> <tr><td>40°F</td><td>23,000 "</td></tr> <tr><td>50°F</td><td>18,000 "</td></tr> <tr><td>60°F</td><td>14,500 "</td></tr> <tr><td>70°F</td><td>11,000 "</td></tr> <tr><td>110°F</td><td>5,200 "</td></tr> <tr><td>120°F</td><td>4,200 "</td></tr> <tr><td>130°F</td><td>3,600 "</td></tr> <tr><td>140°F</td><td>3,000 "</td></tr> <tr><td>150°F</td><td>2,500 "</td></tr> <tr><td>160°F</td><td>2,100 "</td></tr> </tbody> </table> 3. Bad Moisture-Matic®II board. 4. Bad moisture control potentiometer. Check potentiometer with ohmmeter. 5. Burner temperature not holding steady. 	Thermistor Temp.	Thermistor Resistance	30°F	29,000 OHMS	40°F	23,000 "	50°F	18,000 "	60°F	14,500 "	70°F	11,000 "	110°F	5,200 "	120°F	4,200 "	130°F	3,600 "	140°F	3,000 "	150°F	2,500 "	160°F	2,100 "
Thermistor Temp.	Thermistor Resistance																								
30°F	29,000 OHMS																								
40°F	23,000 "																								
50°F	18,000 "																								
60°F	14,500 "																								
70°F	11,000 "																								
110°F	5,200 "																								
120°F	4,200 "																								
130°F	3,600 "																								
140°F	3,000 "																								
150°F	2,500 "																								
160°F	2,100 "																								

General

Check to make sure that all the parts and hardware listed on the packing list have been received. Make claims for any shortages immediately.

The fan end of the dryer is the FRONT. LEFT and RIGHT is determined by standing at the rear of the dryer looking at the rear doors. LEFT and RIGHT of the control cabinet is determined by looking from the inside out through the control cabinet doors.

IMPORTANT: When setting up the dryer avoid dropping nuts, bolts or parts down the grain columns. If anything is accidentally dropped it must be removed before filling the dryer with grain.

Canadian Requirements

Dryers to be operated in Canada must comply with the following:

1. "The equipment shall be installed in accordance with the current Installation Code for Gas Burning Appliances and Equipment, CAN1 B149.1 and B149.2 and/or applicable Provincial Regulations which should be carefully followed in all cases. Authorities having jurisdiction should be consulted before installations are made."
2. "All electrical connections are to be made in accordance with CSA C22.1 Canadian Electrical Code Part 1 and/or Local Codes."

Permanent Installation

The dryer must be installed on a level concrete foundation designed to carry the weight of the dryer when full of grain (Model 670 approx. 27,600 lbs., Model 690 approx. 27,150 lbs. and Model 970 approx. 40,670 lbs.). The foundation must be engineered locally for ground and weather conditions to prevent settling and frost upheaval.

IMPORTANT: The dryer must be a minimum of 12 inches above the ground to provide clearance to open the quick clean unload auger pans. If the dryer is set on concrete piers perpendicular to the dryer skids, they must be notched to provide

the minimum 12 inch clearance. Refer to the dryer base dimension drawing at the back of this manual.

A dryer dimension drawing and an electrical and gas piping entrance drawing are at the back of this manual.

A vibration damper (treated wood planks, flat belting etc.) should be used between the skids and the top of the piers. Be sure to anchor the dryer base to the foundation.

Lift the dryer onto the piers with four slings - two on each side. Attach the slings to or around the skids just behind the fan housings and approximately one third in from the rear of the dryer. Use spreader bars across the top to avoid damage when lifting. Empty weight of the Model 670 is approx. 6600 lbs., Model 690 approx. 6150 lbs. and the Model 970 approx. 9200 lbs.

NOTE: The top of each pier must be level. If they are not, shim between the top of the pier and the vibration damper.

Portable or Temporary Installation

Place timbers or railroad ties under the skids (parallel). The dryer must be a minimum of 12" above the ground to provide clearance to open the quick clean unload auger pans.

A dryer dimension drawing and an electrical and gas piping entrance drawing are at the back of this manual.

Anchoring the Dryer

Immediately after installation, anchor the base of the dryer to the foundation. The dryer should also be guy wired in locations where the possibility of "blow-over" from wind exists.

All anchoring material and cable are to be supplied and installed by the customer.

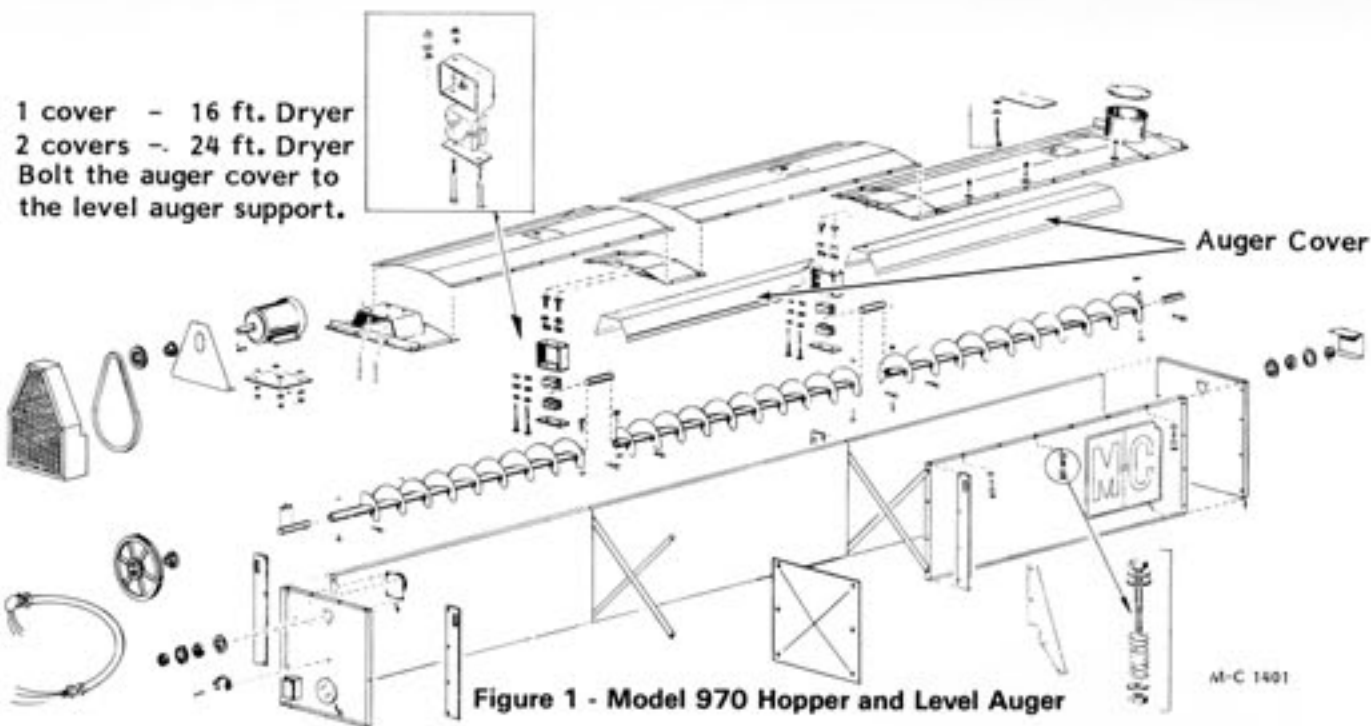

Hopper and Level Auger (See Figure 1)

NOTE: The hopper can be assembled on the dryer or on the ground and lifted on to the dryer. If it is assembled on the dryer, place the stiffener straps across the hopper mount angles as explained in step 1 under "Hopper Installation" on page 8.

1. Install the bin level indicator (with flexible conduit) to the inside of the hopper front end panel with $\frac{1}{4}$ -20 x $\frac{1}{2}$ " truss head screws and two-way locknuts, see Figure 2. Secure the 90° fitting with nut provided and thread the Slater junction box (Figure 3) onto the 90° fitting.
2. Bolt the hopper sides and end panels together with $\frac{3}{8}$ -16 x $\frac{3}{4}$ " capscrews and flanged locknuts. The cross straps go between the hopper sides. Install the four lift bars at the four corners on 16' dryers and at the front of the hopper, and at the front of the third hopper side panel on 24' dryers. Use $\frac{3}{8}$ -16 x 1" capscrews and flanged locknuts.
3. Assemble the level auger bearing(s) to the level auger support(s), see Figure 4. **DO NOT** put pressure on the wood bearings by over tightening the bearing bars, see Figure 4.
4. Install a 1 $\frac{1}{4}$ " bearing w/lock collar and flangettes in each hopper end panel. Secure with $\frac{3}{8}$ -16 x $\frac{3}{4}$ " carriage bolts and flanged locknuts.

5. Install the level auger front shaft (10" long w/key way) and a center shaft (10 $\frac{1}{4}$ " long) into the front auger (82 $\frac{3}{8}$ " flighting). Bolt the shafts to the auger with two $\frac{3}{8}$ -16 x 2" capscrews (grade 5) and two-way locknuts in each shaft.
6. Insert the auger front shaft through the bearing in the front end panel. Do not tighten the bearing lock collar.
7. Slide the level auger support assembly onto the center shaft and bolt the level auger support to the hopper sides with $\frac{3}{8}$ -16 x $\frac{3}{4}$ " capscrews and flanged locknuts.
8. **24' Dryers** - Install a center shaft (10 $\frac{1}{4}$ " long) into the center level auger (93 $\frac{1}{2}$ " flighting) and secure with two $\frac{3}{8}$ -16 x 2" capscrews (grade 5) and two-way locknuts. Slide the auger onto the center shaft in the front level auger. Slide the other level auger support assembly onto the center shaft and bolt the level auger support to the hopper sides. Align the flighting and bolt the center auger to the center shaft with two $\frac{3}{8}$ -16 x 2" capscrews (grade 5) and two-way locknuts.
9. Slide the rear auger (93 $\frac{1}{2}$ " flighting) onto the center auger shaft and support the rear of the auger. Align the flighting and bolt the rear auger to the center shaft with two $\frac{3}{8}$ -16 x 2" capscrews (grade 5) and two-way locknuts.

Problem	Possible Cause	Remedy
	3. Wet grain slug covering temperature probe.	3. Operate in MANUAL for several minutes to clear area.
	4. Loose wire or defective switch(es).	4. Trace power flow. See discharge circuit schematic at back of this manual.
	5. Defective Moisture-Matic®II control.	5. Replace.

SCR Drive Motor Runs Erratically (Metering roll switch in MANUAL position)

Problem	Possible Cause	Remedy
A. Motor speed fluctuates.	1. Loose connection from speed control potentiometer.	1. Trace power flow. See discharge circuit schematic at back of this manual.
	2. Defective speed control potentiometer.	2. Replace potentiometer.
	3. Motor is at current limit.	3. See "Trim Pot Adjustment" on page 33.
	4. Too much "IR" compensation.	4. See "Trim Pot Adjustment" on page 33.
B. Speed control does not regulate motor speed.	1. Loose connection from speed control potentiometer	1. Trace power flow. See discharge circuit schematic at back of this manual.
	2. Defective speed control potentiometer.	2. Replace.
	3. Minimum and maximum speed set incorrectly.	3. See "Trim Pot Adjustment" on page 33.
	4. Defective SCR board.	4. Replace.
C. Motor runs backwards.	1. Motor leads reversed.	1. Switch leads.
D. Repeated blowing of SCR board 10 amp. fuse	1. Low input voltage between "AC Line" terminals on SCR board.	1. Check - should be above 110 volts AC.
	2. Current limit set too high.	2. See "Trim Pot Adjustment" on page 33.

Troubleshooting Discharge System



CAUTION: To avoid electrical shock that could result in personal injury or possible death, always use properly insulated tools when checking electrical components and circuits. **NEVER** check circuit continuity by shorting terminals with a screwdriver or other metal devices.

SCR Drive Motor Does Not Run (Metering roll switch in MANUAL position)

Problem	Possible Cause	Remedy
A. No 115 volt AC input between "AC Line" terminals on SCR board.	<ol style="list-style-type: none"> 1. Discharge auger not running. 2. SCR 8 amp. circuit breaker tripped. 3. Defective or dirty discharge relay. 4. Loose wire or defective switch(es). 	<ol style="list-style-type: none"> 1. Start discharge auger. 2. Reset. 3. Clean or replace if necessary. 4. Trace power flow. See discharge circuit schematic at back of this manual.
B. No DC voltage output between "Arm + and Arm -" terminals on SCR board.	<ol style="list-style-type: none"> 1. SCR board 10 amp. fuse blown. 2. Minimum motor speed set incorrectly. 3. Defective speed control. 4. Defective SCR board. 	<ol style="list-style-type: none"> 1. Replace. 2. See "Trim Pot Adjustment" on page 33. 3. Replace. 4. Replace.
C. Have 115 volt AC input between "AC Line" terminals and output of 6 to 85 volts DC between "Arm + and Arm -" terminals.	<ol style="list-style-type: none"> 1. Overload condition. 2. Current limit set incorrectly. 3. Maximum motor speed set incorrectly. 4. Worn or improperly seated motor brushes. 5. Moisture or dirt accumulation in motor. 6. Defective motor. 	<ol style="list-style-type: none"> 1. Check metering rolls and gear box for binding. 2. See "Trim Pot Adjustment" on page 33. 3. See "Trim Pot Adjustment" on page 33. 4. Replace or adjust. 5. Disassemble and dry or clean. 6. Replace.

SCR Drive Motor Does Not Run (Metering roll switch in AUTOMATIC position)

NOTE: Operation of the moisture control is explained under step 5 on page 18.

Problem	Possible Cause	Remedy
A. Motor operates normally when metering roll switch is in the MANUAL position, but not in the AUTOMATIC position.	<ol style="list-style-type: none"> 1. Moisture control set too high. 2. Grain temperature not high enough to allow discharge. 	<ol style="list-style-type: none"> 1. Adjust set point. 2. Allow time.

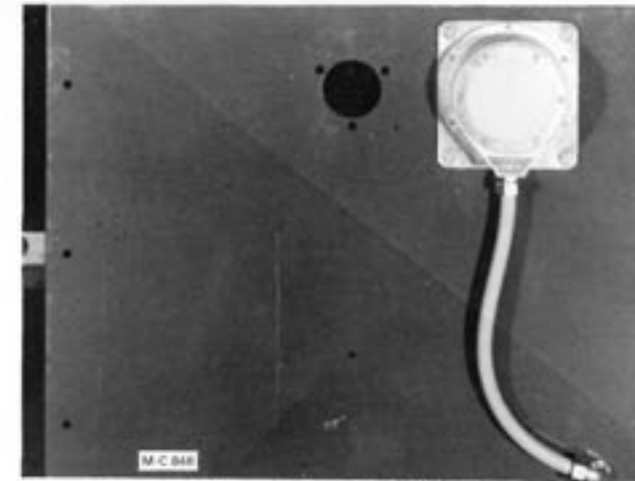

Figure 2 - Bin Switch

10. Slide the level auger rear shaft (8" long) through the bearing in the rear end panel into the rear auger. Do not tighten the bearing lock collar. Bolt the rear shaft to the rear level auger with two $\frac{3}{8}$ - 16 x 2" capscrews (grade 5) and two-way locknuts.
11. Rotate the level auger by hand and check alignment. Tighten both bearing lock collars and set screws.
12. Bolt the receiving hopper and level auger motor mount to the top of the hopper with $\frac{3}{8}$ - 16 x $\frac{3}{4}$ " capscrews, flatwashers and flanged locknuts. Bolt the stub guard to the top of the rear end panel.
13. Install the hopper covers. The front and rear covers are 76" long and the center cover on 24' dryers is 83" long. Secure the covers to the left side with $\frac{1}{4}$ -20 x 2" capscrews, flatwashers, springs and two-way locknuts as shown in Figure 1. Use the end holes and two middle holes only. Bolt the right side with $\frac{3}{8}$ -16 x $\frac{3}{4}$ " capscrews, flatwashers and flanged locknuts.

Level Auger Motor

1. Bolt the level auger motor to the motor mount plate. Use $\frac{3}{8}$ -16 x $1\frac{1}{4}$ " capscrews and flanged locknuts on 2 HP single phase motors and $\frac{5}{16}$ -18 x $\frac{3}{4}$ " capscrews and flanged locknuts on all other motors.
2. Put four $\frac{1}{2}$ -13 x $3\frac{1}{2}$ " full thread capscrews in the level auger motor mount and lock in place with flanged locknuts. Thread a $\frac{1}{2}$ -13 hex nut onto each capscrew and install the motor mount plate with motor, see Figure 3.
3. Install the level auger guard back as shown in Figure 3. Install a $\frac{1}{4}$ " x $1\frac{1}{2}$ " key in the level

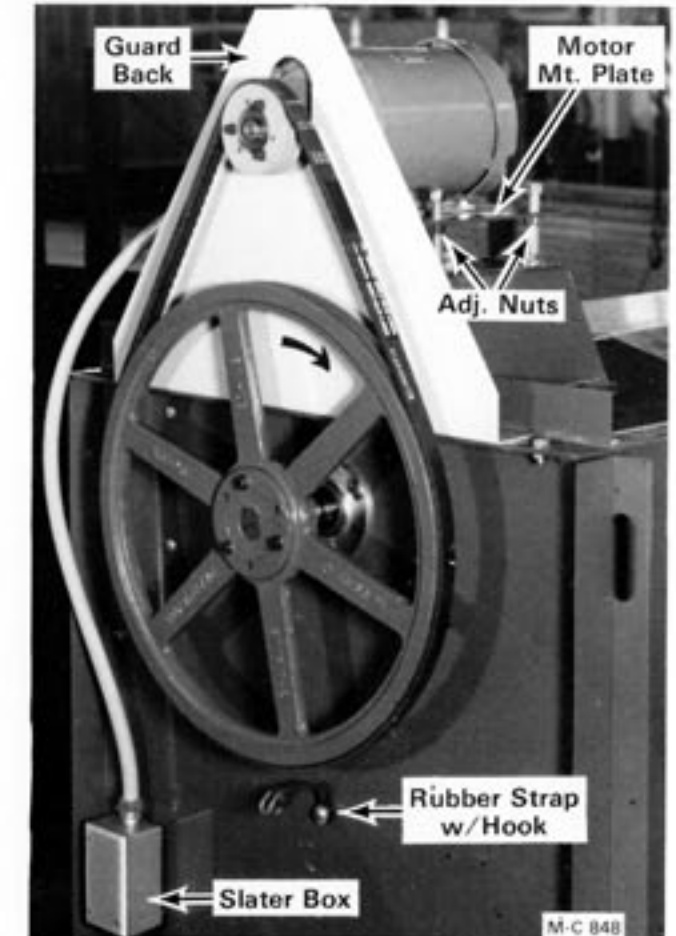

Figure 3

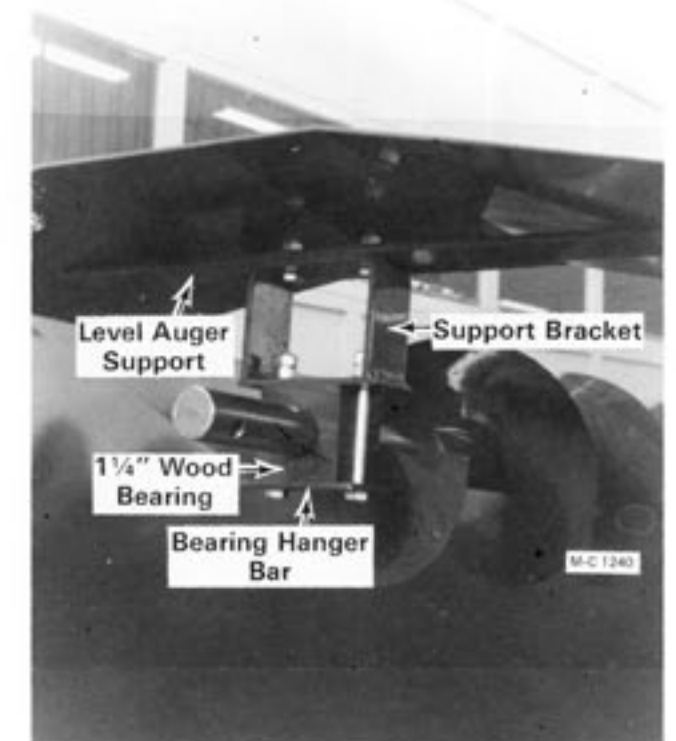

Figure 4 - Level Auger Bearing

auger shaft and a 3/16" x 1 3/8" key in the 1 1/2 HP motor shaft or a 3/16 x 1 5/8" key in the 2 HP motor shaft.

4. The level auger pulley and motor pulley are held on the shafts with tapered bushings. Before installing the pulleys and bushings thoroughly inspect the tapered surface of the bushings. Any paint, dirt, oil or grease **must** be removed.

5. Place the SK bushing (1 1/4" bore) into the level auger pulley and the SH bushing (5/8" or 7/8") bore into the motor pulley. The bushing and the bore of the pulley are tapered. Be sure to install the bushing into the large ID of the pulley tapered bore. If the bushing is installed into the small ID of the pulley, the pulley hub will crack when the mounting capscrews are tightened.

6. Place the three capscrews through the open holes in the bushing and thread them into the pulley by hand. **DO NOT** tighten the capscrews.

IMPORTANT: The capscrew and pulley threads must be clean and dry. Do not lubricate.

7. Slide the pulleys and bushings onto the shafts. If the bushings are too tight on the shaft, wedge a screwdriver blade into the saw cut in the flanged (not the tapered surface) to spread the bushing.

8. Install the belt and adjust the position of the pulleys to align the belt.

9. Tighten the three capscrews in the bushings evenly and progressively. Torque motor bushing capscrews to 9 ft. lbs. and level auger pulley bushing capscrews to 15 ft. lbs.

IMPORTANT: The tightening force on the three capscrews is multiplied many times by the wedging action of the bushing tapered surface. Do not exceed the specified torque, or use a lubricant on the capscrew threads. To do so may create bursting pressures in the hub of the pulley.

NOTE: There should be a 1/8 to 1/4 inch gap between the pulley hub and the flange of the bushing. If the gap is closed, the shaft is undersize.

10. Adjust the belt tension by loosening the locknuts and raising the motor mount plate evenly with the four adjusting nuts, then tighten the locknuts.

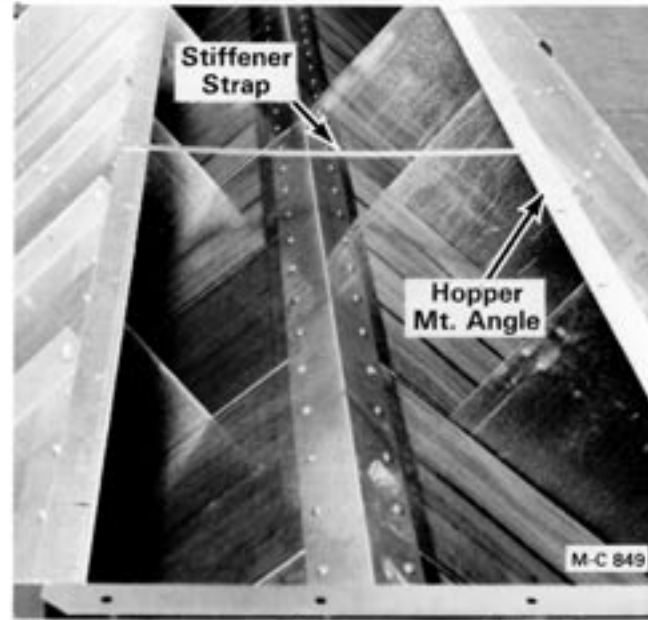

Figure 5

11. Install the rubber strap with hook to the front end panel as shown in Figure 3. Hook the level auger guard over the top of the guard back and secure with rubber strap and hook.

12. Remove the level auger motor junction box cover and the Slater junction box cover. Connect the flexible conduit wire assembly (36" long) to the motor and Slater box.

13. **Three phase motor** - Connect the wires in the level auger motor junction box to the terminals on the motor as follows:

Connect the red wire to terminal T1, blue wire to terminal T2 and the black wire to terminal T3.

14. **Single phase motor** - Refer to the wiring information on the inside of the level auger motor junction box cover. The level auger pulley **MUST** turn clockwise (viewed from the front of the dryer). Determine correct motor rotation and connect the red and black wires to the motor terminals specified on the diagram in the junction box cover.

Hopper Installation

1. Place a stiffener strap (28" long) across the center of the hopper mount angles on the screens (two on 16' and three on 24' dryers), see Figure 5.

2. Attach cables to the lift bars on the hopper. Use spreader bars between the cables and lift the hopper to the top of the screens.

SCR Board Trim Pot Adjustment Procedure

NOTE: Figure 41 shows approximate trim pot settings. Follow adjustment procedure below for final calibration.

Trim Pot	Function	Adjustment
MIN.	Sets Minimum Motor Speed when Speed Control is set at zero. CW rotation will increase minimum motor speed.	<ol style="list-style-type: none"> 1. Set SPEED control to zero. (Fully CCW) 2. Rotate Min pot CW until desired Min speed is reached (5.6 volts DC or 100 RPM).
MAX.	Sets Maximum Motor Speed when Speed Control is set at maximum (10) 100% rotation CW. CW rotation of MAX trim pot increases maximum motor speed.	<ol style="list-style-type: none"> 1. TURN DRIVE POWER OFF! 2. Connect DC Voltmeter: + to + Arm, - to - ARM. 3. Set meter voltage range: (90 VDC) 4. Turn power on. Set SPEED control at 100% (10). 5. Adjust MAX pot to rated motor armature voltage as shown on meter (85 volts DC). <p>NOTE: A tachometer or strobe maybe used in lieu of a meter. Follow above steps, except adjust MAX pot to rated motor speed (1750 RPM).</p>
ACCEL	Allows Adjustment of Acceleration.	<ol style="list-style-type: none"> 1. CW rotation increases time of acceleration (.5 to 8 seconds).
IR COMP	Calibrates speed regulation — % speed change from no load to full load at adjusted speed.	<ol style="list-style-type: none"> 1. Set Speed control at 50% (5). 2. Turn IR COMP pot CW until motor begins to hunt. 3. Turn IR COMP CCW until hunting stops. 4. Set IR COMP pot 1/3 of the span between where motor hunting stopped and fully CCW position. <p>NOTE: For more precise calibration, a tachometer or strobe may be substituted for the above.</p>
CUR. LIM.	Limits DC motor armature current (torque) to prevent damage to the motor or SCR board. The current limit is set for the rated motor current. CW rotation of this trim pot increases the armature current (or torque produced).	<ol style="list-style-type: none"> 1. TURN DRIVE POWER OFF! 2. Connect a DC Ammeter between A1 on motor and + ARM on SCR board. This is in series with motor. 3. Turn power on. 4. Set SPEED control at 50% (5). 5. Apply friction braking to the motor shaft until motor stalls. (zero RPM) 6. While motor is stalled, set current at 125% of rated motor armature current on the nameplate 4.4 amps (3.5 amps x 125%) by adjusting the CUR LIM pot. Remove ammeter after calibration.

Discharge System

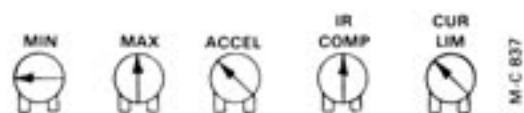

Figure 41 - Approximate Trim Pot Settings

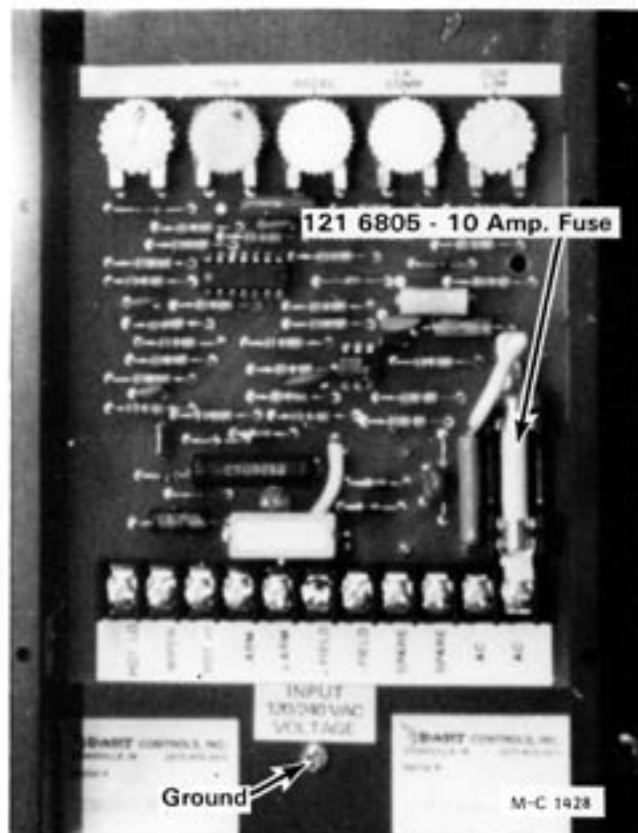

Figure 42 - SCR Drive Control Board

Description

The metering rolls are driven by a 1/3HP variable speed permanent magnet DC motor and reduction gear box. The RPM range of the metering rolls is 1/2 to 10.

The speed of the motor is directly proportional to the amount of DC voltage supplied to it. When voltage increases speed increases and when voltage decreases speed decreases.

The SCR control board converts incoming AC current to DC current and controls the amount of DC voltage going to the motor. The SCR speed control regulates the amount of DC voltage the SCR control board supplies to the motor.

When the discharge metering roll switch is in the AUTOMATIC position, the moisture control controls the SCR board as explained in step 5 on page 18.

SCR Board Terminal Strip Connections

- POT LO** - Connects to low side (white wire) of speed control. **INPUT MUST NOT BE GROUNDED** or serious damage to SCR board may result.
- WIPER** - Connects to (+) of Moisture-Matic®II board.
- POT HI** - Connects to high side (black wire) of speed control. **INPUT MUST NOT BE GROUNDED** or serious damage to SCR board may result.
- + ARM** - Connects to motor armature wires 0-90 volts DC. **MUST NOT BE SWITCHED OR BROKEN WHILE POWER IS ON** or serious damage to SCR board may result.
- ARM** - Connects to motor armature wires. Reverse + and - motor leads to reverse motor rotation. **MUST NOT BE SWITCHED OR BROKEN WHILE POWER IS ON** or serious damage to SCR board may result.
- + FIELD** - NOT USED (Shunt wound motors)
- FIELD** - Connects to (-) of Moisture-Matic®II board.
- SPARE** - NOT USED
- SPARE** - NOT USED
- AC LINE** - Connect hot wire 115 volt AC.
- AC LINE** - Connect neutral wire (white).

The hopper for 16' dryers weighs approximately 450 pounds and the 24' approximately 550 pounds.

3. Bolt the hopper to the hopper mount angles with 3/8-16 x 3/4" capscrews and flanged locknuts.

Level Auger Motor and Bin Switch Wiring

NOTE: The level auger wire assembly consists of a length of 1/2" flexible conduit.

1. Connect the flexible conduit to the bottom of the Slater junction box on the hopper front end panel, see Figure 3.
2. Connect the wires in the Slater junction box together with wire nuts furnished as follows: (tape all connections)
 - A. Connect the two wires imprinted TB24 → LSW-C together, connect the two wires imprinted LSW-NC → LASW together.
 - B. Connect the two black wires together, two red wires together and two blue wires together (blue used on three phase dryers only).

Fan Clearance

NOTE: Remove the tie down wire from each fan. These wires keep the fans from rotating during shipment.

1. Before turning on the electric power, check for clearance between fans and fan housings. The fit between fan and housing is very close. Some shifting may have occurred during shipping. Clearance can be checked by turned each fan by hand.
2. To adjust fan clearance, loosen the four locknuts under the motor base and turn the adjusting nuts on top to raise or lower the motor, see Figure 6. The holes in the base are slotted to allow for side to side adjustment. Tighten locknuts after adjustment has been completed.
3. Install the fan guards.



CAUTION: Do not touch any part of the fan while it is in motion - even when turned by hand.

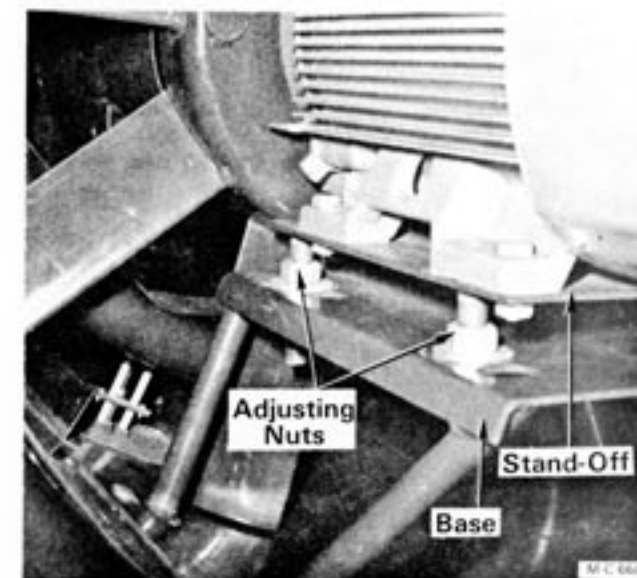

Figure 6

Filling Equipment (Customer Supplied)

1. There are two general methods used to fill the dryer—downspouting from an overhead wet bin or with an auger from the wet bin.
2. Be sure that the system used has the grain moving capacity to fill the dryer faster than the grain shrinks and dries. If it does not, the Grain Flow Timer will shut the dryer down when the grain level in the hopper is low.
3. **Gravity Filling System** — To prevent overloading the level auger, a slide gate must be installed in the downspout to regulate the flow of grain to the level auger.

Loading Augers and Take Away Equipment

1. Customer supplied loading augers **MUST** be controlled by the dryer. The take away equipment can be controlled by the dryer or by a separate source.

IMPORTANT: The control power to the loading auger must come from the auxiliary contact in the dryer level auger magnetic starter. If the dryer controls the take away equipment, it must be controlled by the auxiliary contact in the dryer unload auger magnetic starter.

The jumper wire(s) supplying power to the 115 volt coil on customer supplied magnetic starters must be removed before attaching any wires to the auxiliary contact in the dryer level and unload auger magnetic starter.

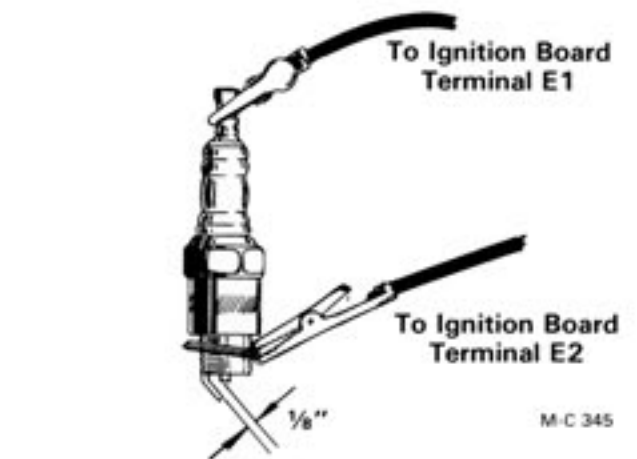
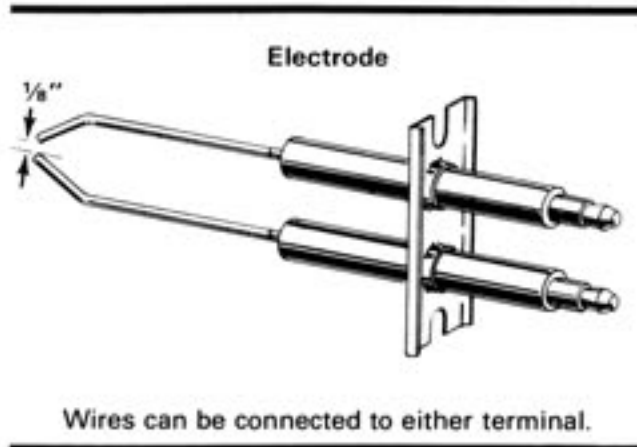

Figure 40

- B. Examine the electrode in the dryer for damage or improper gap. The gap must be 1/8 inch. Also check for porous or cracked ceramic insulator(s) that could hold moisture. The electrode cannot be repaired. If it is damaged or defective, it must be replaced.

CAUTION: After completing tests or repairs, the jumper wire on the air pressure switch must be removed before starting the dryer.

Checking Gas Solenoid Valves

1. Close the gas main hand valve in the control cabinet. Turn off the electric power to the dryer. Flip all of the toggle switches on the control panel to the OFF position. Turn off the fan motor circuit breaker.
2. Disconnect the two wires at the back of the air pressure switch and connect them together with a short jumper wire. Do not

allow the jumper wire to come in contact with any metal. This will by-pass the air pressure switch.

CAUTION: This is only a temporary test procedure. Do not run the fan and burner with the air pressure switch disconnected or by-passed. This safety air pressure switch is for your protection and the protection of the dryer.

3. Turn on the electric power supply to the dryer. Flip the control circuit toggle switch ON, then push it up to the START position and release it.
4. Push the fan start button. The air pressure light will be on.
5. Check to be sure that there is 115V power to the ignition board. Connect a voltmeter between terminal A (L1) and L2 on the ignition board, see Figure 38 and 39.
6. Flip the ignition switch ON. After the 10 second delay the voltmeter should read 115V.
7. If the voltmeter does not read 115V, check the 10 second delay and the ignition switch with a voltage tester. Also check for loose or broken wires from the ignition switch to the ignition board.
8. If there is 115V between terminal A (L1) and L2 check for 115V at terminal B (V1) on the ignition board, see Figure 39 and 40. Connect a voltmeter between terminal V2 and B (V1) on the ignition board.
9. Flip the ignition switch OFF then ON. After the 10 second delay the voltmeter should read 115V. If not, the ignition board is defective and must be replaced.

NOTE: The voltmeter will show a reading during the "trial ignition" period only, (5 seconds). To check again, flip the ignition switch OFF then ON. The 5 second "trial ignition" period starts after the 10 second delay.

10. If there is 115V at terminal B (V1) check to be sure that both solenoid valves are working. To do this, remove the red cap on top of the solenoid valve. Hold a screwdriver near the coil and flip the ignition switch OFF then ON. If the coil is working, a magnetic attraction will be felt (after the 10 second delay).

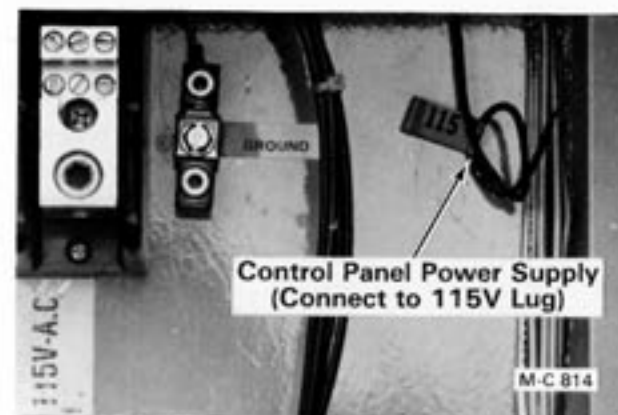

Figure 9

2. An Excess Flow valve must be installed on the LP tank. One is furnished with the dryer. **NEVER** have two Excess Flow tank valves installed on the same LP Gas Line.
3. Each burner requires 12 to 20 lbs. (less in mild weather) of gas pressure at the gauge in the manifold when operating.
4. Consult the LP Gas supplier for gas line size required from the supply tank to the dryer that will provide the amount of fuel to meet the dryer BTU/Hr. requirement at the required operating pressure. See the Gas Consumption (BTU/Hr.) chart.

IMPORTANT: Use type of supply line specified by Local Codes.

5. Connect the LP Gas line from the tank valve to the short flexible LP Gas inlet hose at the front of the dryer on the left side. (Hose not used on dryers operated in Canada).

CAUTION: Before starting the dryer test for any gas leaks. Turn the gas supply on and apply soap water to **ALL** pipe joints and unions, including pipes assembled on the site and those assembled at the factory.

Natural Gas

1. Each burner requires 5 to 10 lbs. of gas pressure at the gauge in the manifold when operating.
2. Consult the gas company for gas supply line size required to the dryer that will provide an adequate volume of gas to meet the dryer (BTU/Hr. requirement at the required operating pressure. See Gas Consumption (BTU/Hr.) chart.

IMPORTANT: Use type of supply line specified by Local Codes.

CAUTION: Before starting the dryer test for any gas leaks. Turn the gas supply on and apply soap water to **ALL** pipe joints and unions, including pipes assembled on the site and those assembled at the factory.

Gas Consumption (BTU/Hr.) see note

	670	690	970
Dry & Cool	2,310,000	—	3,722,000
All Heat	3,608,000	3,515,600	5,570,000

NOTE: BTU/Hr based on normal drying temperatures (at 50°F) drying shelled corn.

Fan Rotation

IMPORTANT: Before checking fan rotation, inspect for and remove any foreign material (nuts, bolts, tools, parts etc.) from the hopper, grain columns, metering rolls, unload auger and heat chambers.

1. Check fan rotation from the front of the dryer. Both fans must turn counter-clockwise.

CAUTION: Do not turn the electric power on until the fan guards have been installed.

2. Flip all switches on the control panel OFF. Turn on the electric power supply to the dryer. The 115V POWER ON light will be on.
3. Flip the control circuit toggle switch ON. The control circuit ON light and high limit lights will be on. If the high limit lights are not on, push the reset button on the high limit switch.
4. Push the spring loaded control circuit toggle switch up to the START position and release it. The READY light and LEVEL AUGER light will be on.
5. With everyone clear of the fans, push the fan start button. Immediately push the stop button, check fan rotation and be sure the fan is not rubbing the housing.

6. If fan rotation is not correct it can be changed as follows:

CAUTION: Turn off and lock the electric power supply to the dryer.

- A. **Three phase motors** - Move the wire from terminal T1 to T3 and T3 to T1 on the fan magnetic starter in the lower control cabinet, see Figure 10.
- B. **Single phase motors** - Refer to the wiring information on the inside of the fan motor junction box cover.

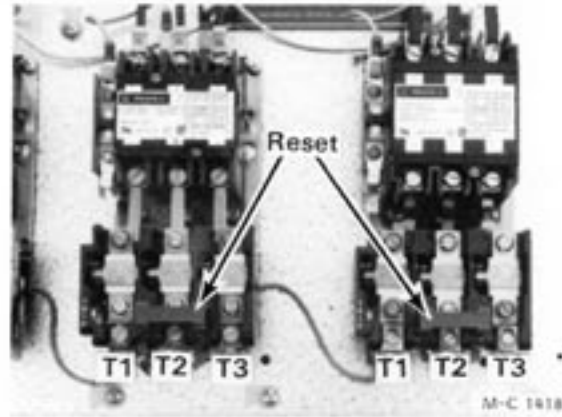

Figure 10 - Fan Magnetic Starters - 3 Phase

Level and Unload Auger Rotation

1. Looking at the front of the dryer, the level auger pulley **MUST** turn clockwise and the unload auger pulley **MUST** turn counter-clockwise. If rotation is not correct it can be changed as follows:

CAUTION: Turn off and lock the electric power supply to the dryer.

- A. **Three phase motors** - Move the wire from terminal T1 to T3 and T3 to T1 on the magnetic starter in the lower control cabinet, see Figure 11.
- B. **Single phase motors** - Refer to the wiring information on the inside of the motor junction box cover.

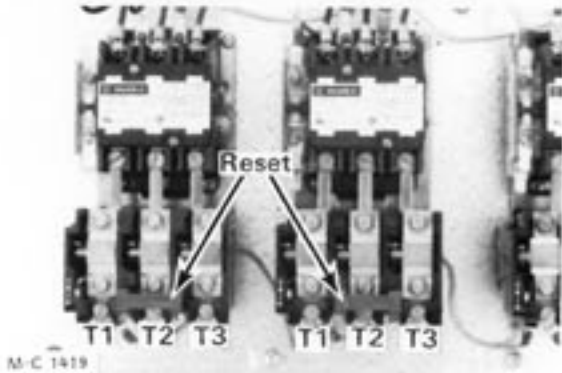

Figure 11 - Level and Unload Auger Magnetic Starters - 3 Phase

CONTROL PANEL LIGHTS, SWITCHES & CONTROLS

Control Panel Lights (See Figure 12)

Ref. 1 - 115V Power On Light

Indicates that 115 Volt electric power to the dryer control panel is on.

Ref. 2 - Control Circuit On Light

Indicates that the control circuit toggle switch is in the on position, the rear discharge overload door is closed and all motor magnetic starter overload relay blocks are closed.

Ref. 3 - Control Circuit Ready Light

Indicates that the control circuit toggle switch has been pushed up to the start position and the dryer is ready to be started.

Ref. 4 - Grain Flow Light

Indicates low grain level in the hopper. The dryer will shut down when this light comes on.

Ref. 5 - Level Auger Light

Indicates that the grain level in the hopper is low and the level auger bin switch in the hopper has closed, activating the level auger circuit.

Ref. 6 - (-) Light

Indicates that the discharge rate is slowing down if Moisture-Matic®II is in automatic.

Ref. 7 - High Limit Light

Indicates that the high limit switch is closed and the temperature in the plenum chamber has not exceeded the high limit setting.

Ref. 8 - Air Pressure Light

Indicates that the air pressure switch is closed and the fan motor magnetic starter is engaged. (Dryer must be full of grain and fans running).

Ref. 9 - Gas Valve Light

Indicates that the ignition board has supplied power to the gas solenoid valves.

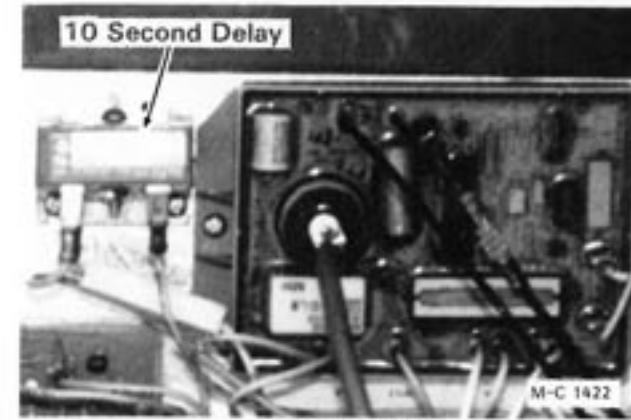

Figure 37

CAUTION: This is only a temporary test procedure. Do not run the fan and burner with the air pressure switch disconnected or by-passed.

7. Turn on the electric power supply to the dryer. Flip the control circuit toggle switch ON, then push it up to the START position and release it.
8. Push the fan start button. The air pressure lights will be on.
9. Flip the ignition switch ON. After the 10 second delay observe the electrode during the "trial ignition" period. In some cases the spark can be heard.

CAUTION: There may be a small amount of gas in the line that could ignite. Flip the ignition switch on and off for several "trial ignition" periods before entering the dryer to observe the electrode.

10. If there is no spark the ignition board must be tested. The ignition board does not have to be removed for this test. Proceed as follows:

A. Flip the ignition switch OFF. Remove the electrode wires from terminals E-1 and E-2 on the ignition board, see Figure 38 and 39.

B. Using a new properly gapped electrode (1/8 inch) or an automotive spark plug gapped to (1/8 inch), connect terminals E-1 and E-2 on the ignition board to the test electrode or spark plug with the jumper wires, see Figure 40.

CAUTION: HIGH VOLTAGE - to prevent severe electrical shock, hold the test electrode or spark plug with an insulated device during the test and keep the wires away from the control cabinet to prevent arcing.

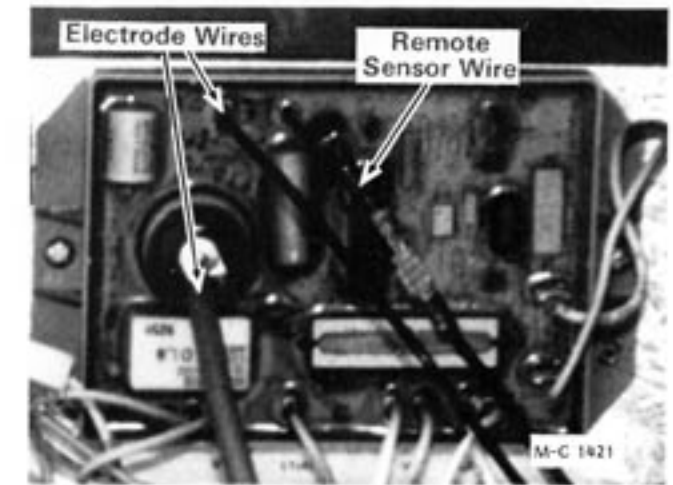

Figure 38

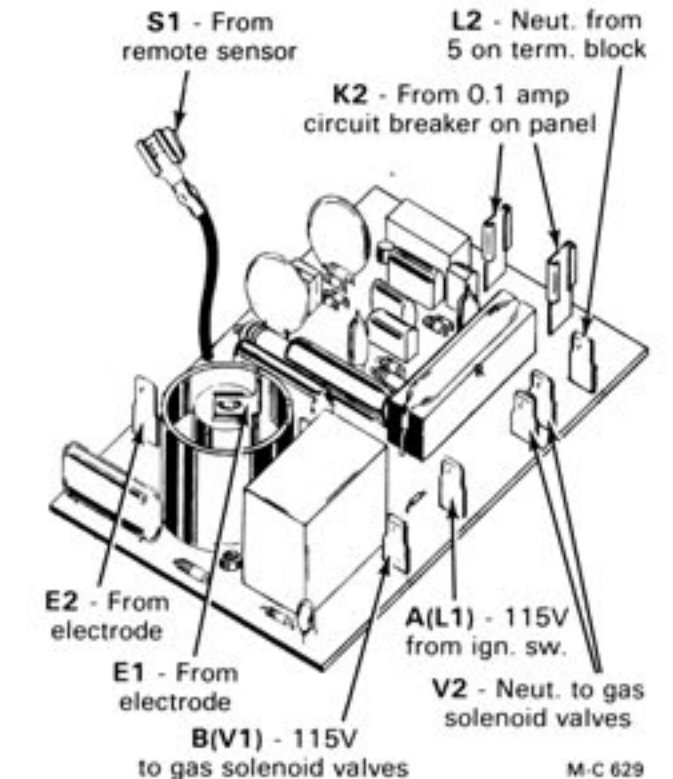

Figure 39

- C. Flip the ignition switch ON and check for spark at the test electrode or spark plug. Spark should occur after the 10 second delay. If a spark does not occur, the ignition board is defective and must be replaced.

11. If there is a spark on the test electrode or spark plug, the electrode on the dryer or the electrode lead wires are defective.

A. Check the condition of the electrode lead wires. The wires must be replaced if they are found to be non-conductive or shorted.

Direct Spark Ignition System

Operation

The direct spark ignition system consists of an electronic ignition board, a direct spark ignition electrode and a remote sensor, Figure 36, for each burner. For ignition to occur, the dryer must be running and the High Limit and Air Pressure lights on the control panel must be on.

The dryer is wired so that the current flow from the control cabinet goes to the High Limit Switch, Fan Start-Stop Button, Fan Magnetic Starter, Air Pressure Switch, Ignition Switch, 10 Second Delay and then to the Ignition Board. This is a safety feature that prevents ignition if the heat chamber temperature is too high or there is insufficient air flow.

The 10 second delay before ignition is also a safety feature that allows the fan to purge the heat chamber of any unburned gas that may remain after a burner has been shut down for any reason.

When the ignition switch is flipped on, the ignition board is energized (after the 10 second delay) and generates a high voltage spark between the tips of the electrode and opens the gas solenoid valves at the same time. The gas valve light on the control panel will be on.

The electrode provides the spark for ignition and the remote sensor senses the presence of the flame. A small amount of electrical current passes from the remote sensor to the flame completing the electrical circuit. If the flame is not present, the circuit will be broken and the ignition system will "lock out".

The ignition board is electronically timed so that when the ignition switch is flipped ON, the electrode will continue to spark and the gas solenoid valves will be held open for a "trial ignition" period (about 5 seconds) - after the 10 second delay.

When ignition occurs and a flame is present, the ignition system will continue to operate (spark shuts off). If ignition fails, flame is not present, the ignition system will "lock out" (after the 5 second trial period) closing the gas solenoid valves. The gas valve light on the control panel will be out. Flip the ignition switch OFF, then ON for another "trial ignition" period.

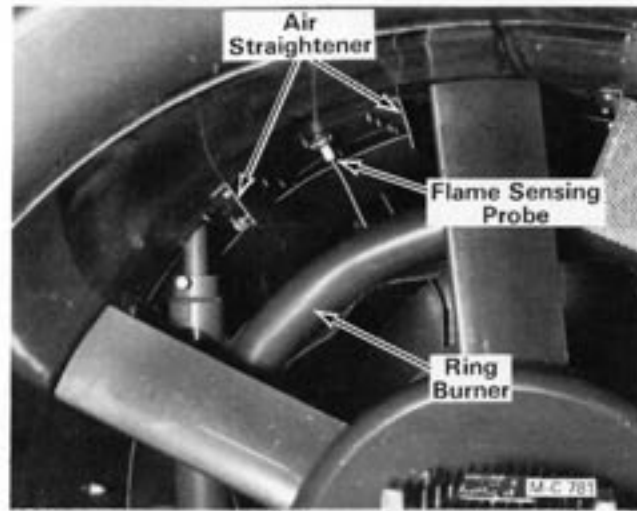

Figure 36

Testing

If after several attempts for ignition there is still no flame, turn the fan off and check the ignition system as follows:

1. Push in ignition reset button (circuit breaker) on the control panel. The circuit breaker protects the ignition board from heat build up due to repeated ignition attempts.
2. The ignition board may have absorbed some moisture during periods of continued rain, fog or blowing snow which would cause the ignition board not to function properly. Carefully dry the ignition board with warm air. Also check the electrode to be sure it is dry.
3. Look for loose, burned or broken wires, poor or corroded connections. Check the 10 second delay, see Figure 37, and the ignition switch with a voltage tester.
4. Check for spark at the electrode. Turn off the electric power supply to the dryer. Flip all of the toggle switches on the control panel to the OFF position. Turn off the fan motor circuit breaker.
5. Close the burner gas main hand valve (handle 90° to the piping.)
6. Disconnect the two wires at the back of the air pressure switch and connect them together with a short jumper wire. Do not allow the jumper wire to come in contact with any metal. This will by-pass the air pressure switch.

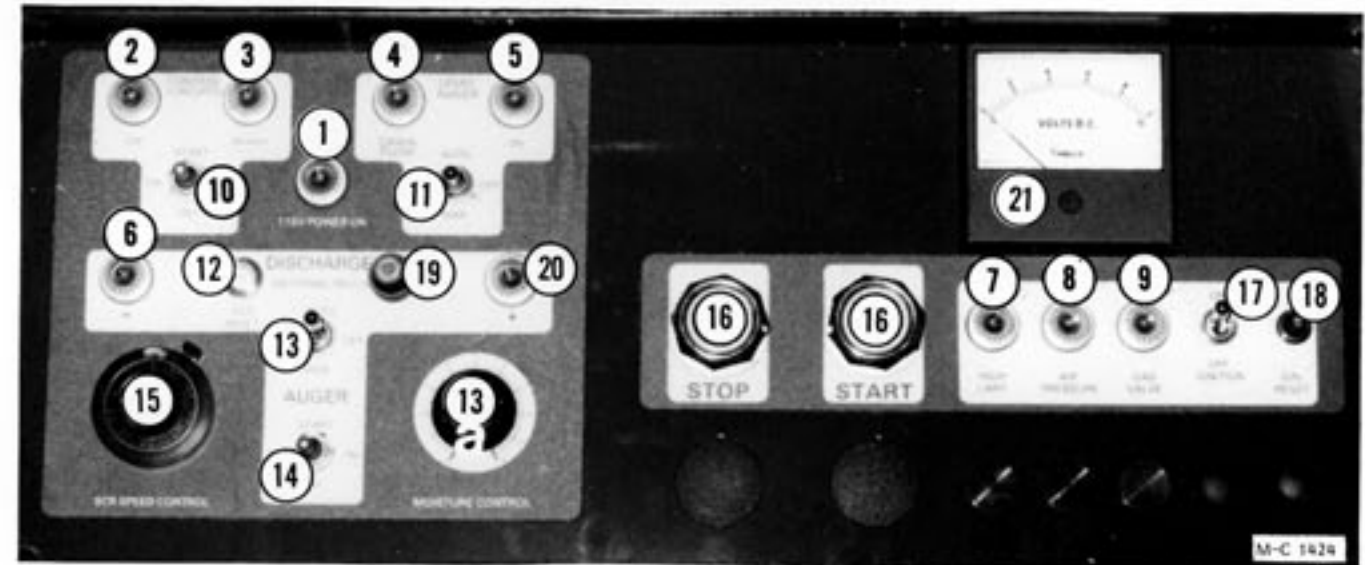

Figure 12

Ref. 10 - Control Circuit Switch

When the switch is in the on position, the control circuit on light will be on if the rear discharge overload door is closed and all magnetic starter overload relay blocks are closed. High limit lights will be on. If they are not, push the reset button on the high limit switches.

When the switch is pushed up to the start position the ready light will be on if both high limit lights are on. When the ready light is on the dryer can be started.

NOTE: If there is a momentary loss of electric power, the dryer will shut down. When the power comes back on, the 115V POWER ON light and the control circuit ON light will be on. The dryer will have to be restarted. This feature prevents an unattended dryer restarting.

Ref. 11 - Level Auger Switch

When the switch is in the manual position the level auger will start immediately when the level auger bin switch in the hopper closes and stop when the hopper is full.

When the switch is in the automatic position, the grain flow timing circuit is activated.

NOTE: The operation of the level auger circuit is explained in detail under "Level Auger Operation" on page 21.

Ref. 12 - SCR Drive Reset Button

The SCR drive reset button (8 amp. circuit breaker) protects the SCR drive control board.

Ref. 13 - Discharge Metering Roll Switch

When the switch is in the automatic position, the Moisture-Matic®II will speed up and slow down the SCR drive motor automatically. Unloading starts when the moisture content of the grain is reduced to the level that the moisture control is set for and slows down or stops when the moisture content is above this setting.

When the switch is in the manual position, the SCR drive motor will run continuously. The operation of the moisture control is explained under "Operation of the Discharge System" on page 18.

Ref. 13A - Moisture-Matic®II Balance Knob

When the discharge metering roll switch is in the automatic position, the Moisture-Matic will control the SCR drive motor to maintain the moisture content of discharge grain.

Ref. 14 - Discharge Auger Switch

This switch starts and stops the discharge auger. Push this spring loaded switch up to start the unload auger and release it. It will move down to the on position.

Ref. 15 - Manual SCR Drive Speed Control

This manual speed control is used to adjust the speed of the DC motor that drives the grain metering rolls and changes discharge speed when metering rolls switch is in the manual position.

Ref. 16 - Fan Start-Stop Buttons

Black button starts and red button stops the fans.

Ref. 17 - Ignition Switch

Flip this switch on to light the burner. After a ten second delay the gas valve light will come on and the burner will light. If the burner does not light in 5 seconds (after the gas valve light comes on) the ignition board will "lock out" closing the gas solenoid valves.

Ref. 18 - Ignition Reset Button

The ignition reset button (0.1 amp. circuit breaker) protects the ignition board from heat build up due to repeated ignition attempts.

Ref. 19 - Moisture-Matic®II Fuse

Ref. 20 - (+) Light

Indicates that the discharge rate is speeding up if Moisture-Matic®II is in automatic.

Ref. 21 - DC Volt Meter

Indicates the DC volts to the DC motor both in manual and automatic.

INITIAL START-UP INSTRUCTIONS

General

IMPORTANT: Inspect for and remove any foreign material (nuts, bolts, tools, parts etc.) from the hopper, grain columns, metering rolls, unload auger and heat chambers before filling the dryer with grain.

1. Flip all of the toggle switches on the control panel to the OFF position.
2. **LP Gas** - Close the liquid line flip valve for each burner (handle down), see Figure 13.
3. Close the gas main hand valve for each burner (handle 90° to the piping), See Figure 14.
4. Check the modulating valve in each burner gas manifold to be sure the "T" handle has not been turned all the way in to the wide open position, see Figure 14. The "T" handle should be halfway between the closed and fully open position.
5. Turn on the electric power supply to the dryer. The 115V POWER ON light will be on.
6. Flip the control circuit toggle switch ON. The control circuit ON light and high limit lights will be on. If the high limit lights are not on, push the reset button on the high limit switch, see Figure 15.

Filling the Dryer

CAUTION: Do not allow anyone to be in the hopper when filling the dryer. Always turn off and lock the electric power supply to the control cabinet before allowing anyone to work in the hopper.

1. Flip the level auger toggle switch to the MANUAL position. The level auger will start immediately and the level auger light on the control panel will be ON.

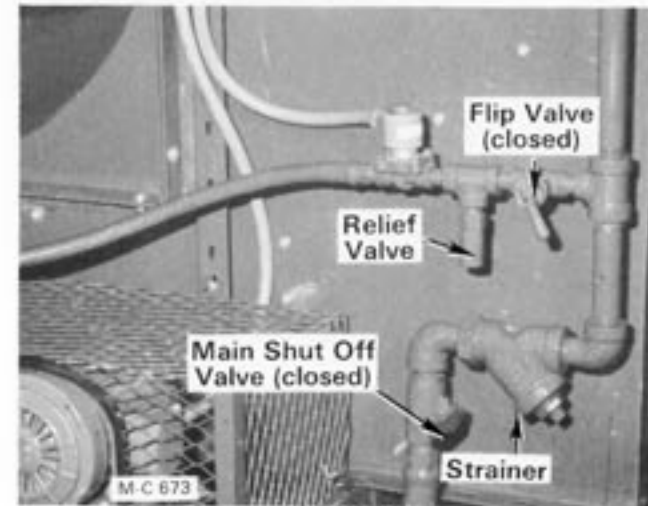

Figure 13

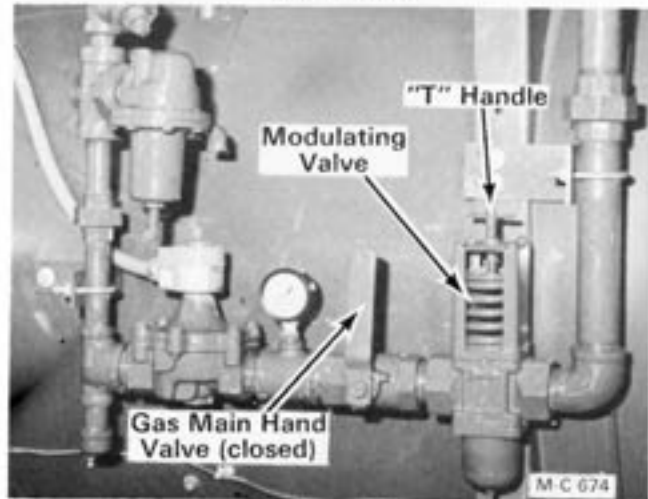

Figure 14

2. When the dryer is full, the grain will open the level auger bin switch in the hopper. The level auger will stop and the LEVEL AUGER light will be out.

High Limit Switch

Adjust High Limit 30° to 50° above operating temperature. This will avoid nuisance shutdowns during start up.



CAUTION: This is only a temporary procedure for checking the burners. When drying grain NEVER operate the dryer with the air pressure switches disconnected or by-passed. This safety air pressure switch is for your protection and the protection of the dryer.

5. Turn on the electric power supply to the dryer. Flip the control circuit toggle switch ON. The control circuit ON light and high limit lights will be on. If any high limit light is not on, push the reset button on the high limit switch, see Figure 32A.
6. Push the control circuit toggle switch up to the start position and release it. The READY and LEVEL AUGER lights will be on.
7. Start the bottom burner fan, the air pressure light will be ON. When the fan comes up to speed, open the gas main hand valve ¼ of the way. Flip the ignition switch ON. After a ten second delay the gas valve light will be ON and the burner will light.

NOTE: The ignition board is electronically timed so that the ignition system will continue to spark and hold the solenoid gas valves open for a "trial ignition" period (about 5 seconds). If the burner does not light the system will "lock out" (after the 5 second trial period) closing the solenoid gas valves. The gas valve light will be out. Flip the ignition switch OFF, then ON again for another "trial ignition" period.

8. If after several attempts for ignition there is still no flame, push the 0.1 (1/10th) amp. ignition reset button (circuit breaker) on the control panel. This circuit breaker protects the ignition board from heat build up due to repeated ignition attempts.
9. If the burner fails to light, check the electrode and ignition board as explained under "Direct Spark Ignition System", page 28.
10. If the ignition system is good, check the Gas Solenoid Valves as explained on page 30. They may be defective stopping gas flow to the burner.
11. After the burner lights, close the gas main hand valve. Run the fan until the burner goes out, then turn the fan off.



CAUTION: Be sure to remove the jumper wire on the air pressure switch and reconnect the two wires that were removed.

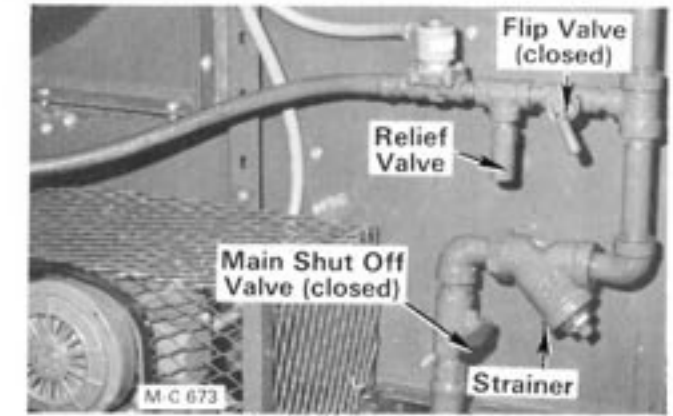

Figure 33 - LP Gas

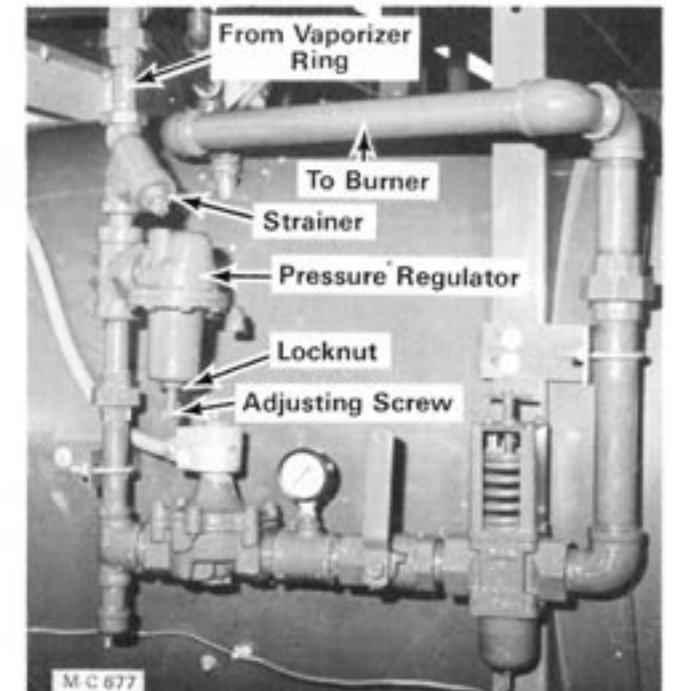

Figure 34 - LP Gas

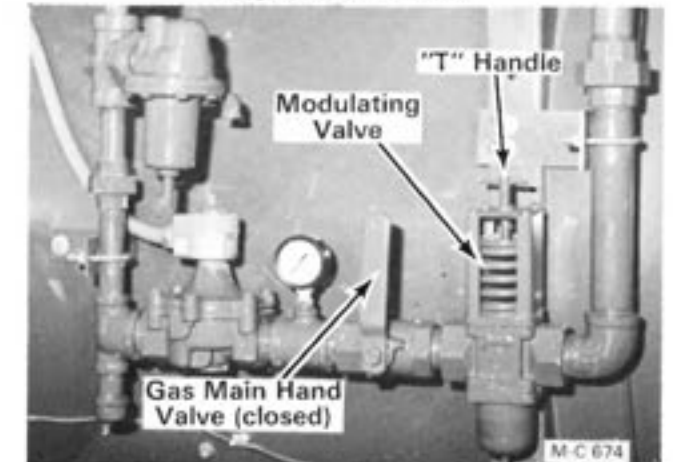

Figure 35 - LP Gas

12. Check the top fan and burner. After the fans and burners have been checked, turn off the gas supply to the dryer. Turn off and lock the electric power supply. Lock the control cabinet doors.

6. Remove the air pressure switches and clean the tube and filter, see Figure 32. Be sure the vent hole in the bottom of the air pressure switch body is open, see Figure 32A.

7. **LP Gas** - Remove the plug at the end of each strainer, see Figure 33 and 34. Remove and clean the screen in each strainer. Check flexible LP hoses for signs of fatigue, replace as necessary.

Level Auger and Discharge System

1. Flip all of the toggle switches on the control panel to the OFF position. Flip all of the circuit breakers in the bottom cabinet ON. Turn the electric power supply to the dryer ON.

2. Flip the control circuit toggle switch ON. Then push it up to the start position and release it. The READY light will be on.

3. Check the level auger. Flip the level auger toggle switch to the MANUAL position. The level auger will start immediately.

4. Push the discharge auger toggle switch up and release it. The discharge auger will start.

5. Flip the discharge metering roll toggle switch to the MANUAL position. The SCR drive motor will start and turn the SCR speed control to change speed.

6. Check the SCR motor speed, slow should be 5 to 6 DC volts. Turn the SCR speed control to ten (10) and check the SCR motor speed, it should be 85 DC volts. If motor speed is not correct, see "Troubleshooting Discharge System" on page 34.

NOTE: To perform the balance of the discharge system check the outside air temperature; must be above 50°F.

7. Set the SCR speed control to mid-range and lock in place. Turn the moisture control to balance the lights.

8. Flip the discharge metering roll switch to AUTOMATIC. The SCR drive motor will run at the speed selected in step 7.

9. Turn the moisture control balance up until (-) light goes on. The SCR motor speed will decrease.

10. Turn the moisture control balance down until the (+) light goes on. The SCR motor will increase.

Fans and Burners

1. Turn off the electric power supply to the dryer. Flip all of the toggle switches on the

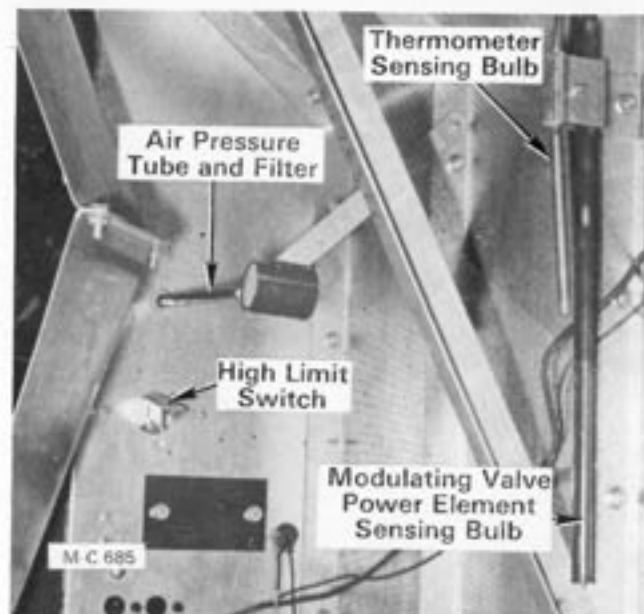

Figure 32

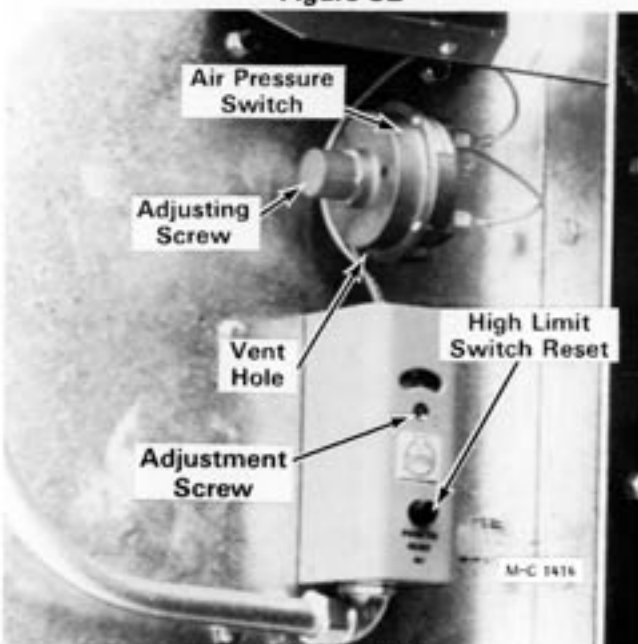

Figure 32A

control panel to the OFF position.

2. Close the gas main hand valve for each burner (handle 90° to the piping), see Figure 35.

3. **LP Gas** - Open the supply valve at the tank, the hand valve at the LP Gas inlet hose and open (lift up) the liquid line flip valve on each burner, see Figure 33.

Natural Gas - Open the supply valve.

4. Disconnect the two wires at the back of each air pressure switch (there is one for each burner), see Figure 32A. Connect the two wires together with a short jumper wire. Do not allow the jumper wire to come in contact with any metal. This will by-pass the air pressure switch.

Air Pressure Switches

General

1. There is an air pressure switch for each heat chamber, see Figure 15. The air pressure switch senses the static air pressure in the heat chamber when the dryer is full of grain and the fan is running. If the static air pressure drops because of fan failure, the air pressure switch opens stopping current flow to the ignition switch. The gas solenoid valves will close and the burner will shut down.

2. The air pressure switch is designed to protect the dryer from fire that may result from fan (air flow) failure while the burner is ignited and flame is present.

CAUTION: This safety feature is for your protection and protection of the dryer. The air pressure switches should be checked for correct operation at the start of the drying season and periodically during the season.

Checking

1. After the dryer has been filled and before any burners are started, the operation of each air pressure switch **MUST** be checked. Be sure the rear doors are closed.
2. Start the fan or fans. When it comes up to speed, start the second fan.

NOTE: The fan magnetic starters are wired in series. If one fan magnetic starter overload relay trips the dryer will shut down. All lights except the POWER ON light will be out. When the overload relay is reset the control circuit ON and high limit lights will be on.

Flip the control circuit switch up to the start position and release it, the READY light will be on. Flip the ignition switches OFF and restart the fans, burners and discharge auger.

3. The air pressure light on the control panel will come ON as the fan comes up to speed.
4. If the light does not come ON or comes ON too soon (before the fan comes up to speed) the air pressure switch must be adjusted.

NOTE: If the light does not come on, remove the air pressure switch and check to be sure the 1/8" vent hole in the bottom of the air pressure switch

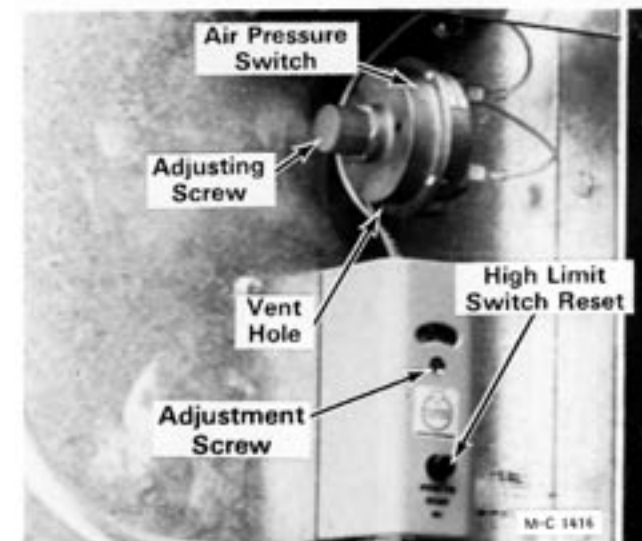

Figure 15

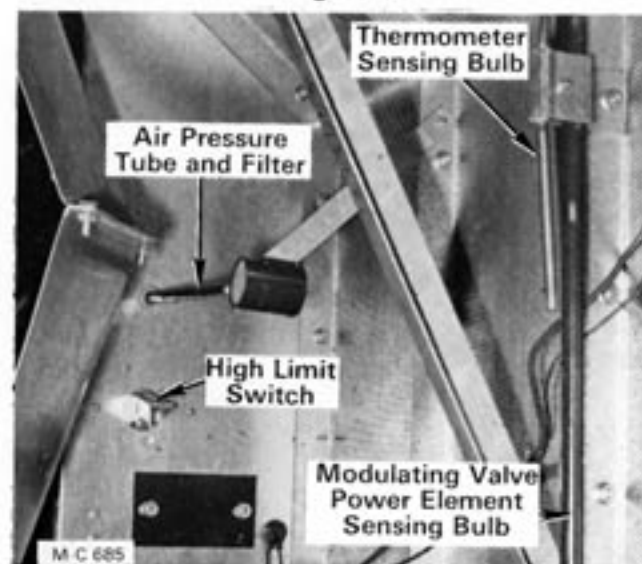

Figure 16

is open, see Figure 15. Also check for an obstruction in the air pressure tube and filter, see Figure 16.

Adjusting

NOTE: Both fans must be running before the air pressure switches can be accurately adjusted.

1. Remove the plastic cap on the air pressure switch. The slotted screw is the adjusting screw, see Figure 15.
2. Turn the adjusting screw in (clockwise) until the air pressure light goes out.
3. Turn the adjusting screw out (counterclockwise) until the air pressure light comes on. After the air pressure light comes on, turn the adjusting screw out an additional 1/2 turn to allow for normal changes in static pressure.

4. Shut off the fan. The Air Pressure light will go out when the fan stop button is pushed. These dryers are wired so that the power flows from the fan start button to the air pressure switch.
5. If all air pressure switch adjustment is used and the Air Pressure light does not come on, the air pressure switch is defective and must be replaced. Check the operation of the new switch. Adjust if necessary.
6. If the air pressure light is blinking, turn the adjusting screw out a small amount.

Starting the Burners

1. **LP Gas** - Open the supply valve at the tank, the hand valve at the LP Gas inlet hose and open (lift up) the liquid line flip valve on each burner, see Figure 13. The flip valve is open when the handle is 90° to the piping.

Natural Gas - Open the supply valve.

2. Start the bottom fan. When it comes up to speed, start the top fan.
3. Open the gas main hand valve (Figure 14) ¼ of the way. Flip the bottom burner ignition switch ON. After a ten (10) second delay the gas valve light will be ON and the burner will light.

NOTE: The ten second delay before ignition is a safety feature that allows the fan to purge the heat chamber of any unburned gas that may remain after a burner has been shut down for any reason.

4. After the flame is established, **slowly** open the bottom burner gas main hand valve all the way (handle parallel to the piping).

NOTE: Opening the gas main hand valve slowly will prevent possible freezing of the LP Gas line and also prevent the temperature from rising too fast. If the temperature rises too fast, the High Limit Switch will trip out and the dryer will shut down.

5. If the LP Gas line freezes, close the gas main hand valve and flip the ignition switch OFF. After the gas line thaws out repeat steps 3 and 4, but open the gas main hand valve slower.

NOTE: The ignition board is electronically timed so that the ignition system will continue to spark and hold the solenoid gas valves open for a



Figure 17

“trial ignition” period (about 5 seconds). If the burner does not light, the system will “lock out” (after the 5 second trial period) closing the solenoid gas valves. The gas valve light will be out.

6. Flip the ignition switch OFF then ON again. The gas valve light will come ON after the ten second delay and another trial for ignition period (5 seconds) will start.
7. If after several attempts for ignition there is still no flame, push the 0.1 (1/10th) amp. ignition reset button (circuit breaker) on the control panel, see Figure 17. This circuit breaker protects the ignition board from heat build up due to repeated ignition attempts.

NOTE: If the burner fails to light, check the electrode, 10 second delay and ignition board as explained under “Direct Spark Ignition System”, page 28.

8. If the High Limit Switch trips out, close the gas main hand valve and flip the ignition switch OFF. Push the reset button on the High Limit Switch to reset it, see Figure 15. Adjust High Limit 30° to 50° above operating temperature. This will avoid nuisance shutdowns during start up.

NOTE: When a High Limit Switch trips out the dryer will shut down. Both fans and burners will have to be restarted.

9. Push the control circuit switch up to the START position and release it. Restart the fan. Repeat steps 3 and 4, but open the gas main hand valve slower to prevent the temperature from rising too fast.

10. **LP Gas Only** - When the flame is established, the heat causes the LP Gas to vaporize. After the burner has been running for 10 minutes check the vaporizer coil as follows:

- A. Check the LP Gas line coming out of the fan housing from the vaporizer coil to the pressure regulator with your hand, see Figure 18.

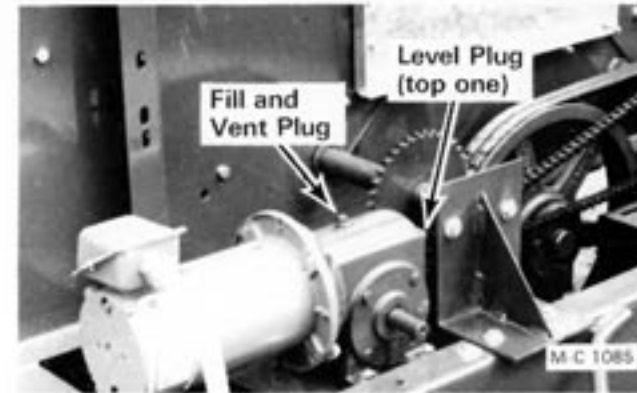

Figure 30

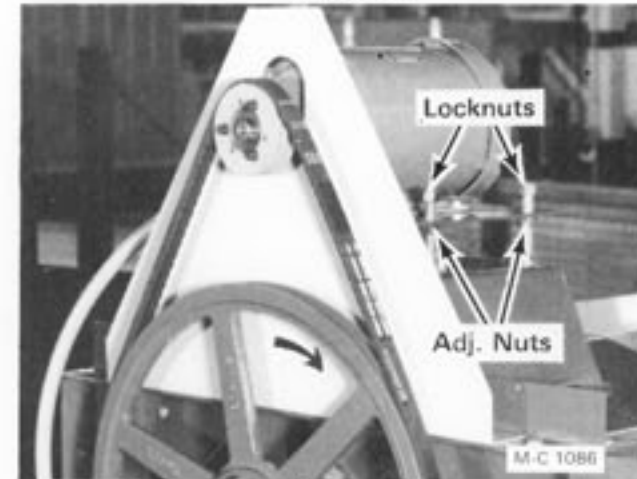

Figure 31

Screens and Heat Recovery System

NOTE: Be sure to keep the inside screens and heat chambers as clean as possible to reduce the possibility of fire. Also, a clean dryer works better than a dirty one.

1. Check the exterior screens periodically and clean as necessary.
2. Clean the inside screens and heat chambers every 8 to 10 hours.
3. If the dryer is equipped with a heat recovery system, remove and clean the bottom covers.

NOTE: Under some drying conditions, the inside screens and heat recovery bottom covers may have to be cleaned more often.

Belt Adjustment

General

1. After approximately 24 hours of operation the belts will seat themselves in the pulley grooves and the tension may have to be readjusted. If the belts squeal when the motor starts they are not tight enough.

2. Never apply belt dressing as this will damage the belt and cause early belt failure.

Discharge Auger

1. Loosen the unload auger motor mounting locknuts. Turn the locknut on the “J” bolt to adjust tension.

Level Auger

1. Adjust the belt tension by loosening the locknuts and raising the motor mount plate evenly with the four adjusting nuts, then tighten the locknuts, see Figure 31.

Pre-Season Check

All of the following tests and adjustments can be made when the dryer is empty. The air pressure switch, modulating valve and vaporizer coil (LP Gas) adjustments can only be made when the dryer is full of grain. These adjustments are covered under “Initial Start-Up Instructions” on page 14.



CAUTION: The gas and electric power supply to the dryer **MUST** be off when performing steps 1 thru 7. Flip all of the circuit breakers in the bottom cabinet OFF. Lock the main electric supply to the dryer so that the power cannot be accidentally turned on.

General

1. Lubricate all bearings, chains and sprockets. Check the oil level in the SCR drive gear box. Refer to “Lubrication” on page 24.
2. Check and adjust the unload and level auger belts. Refer to “Belt Adjustment”.
3. Tighten all electrical connections in the bottom control cabinet. Check the ground connection in the cabinet to be sure it is clean and tight. Also check the ground connection from the dryer base to the grounding rod.
4. Clean out the unload auger and grain metering rolls. Each unload auger pan is hinged on the left side and secured on the right side with two overcenter latches. Push the handle on the latches down to open the pans and pull them up overcenter to lock the pans.
5. Clean all of the screens, fans, burners and heat chambers. Remove and clean heat recovery system bottom covers (if equipped).

7. Flip the discharge metering roll toggle switch to the MANUAL position and start the discharge auger to unload all of the grain. When the dryer is empty, flip the discharge metering roll and discharge auger toggle switches OFF. Flip the control circuit toggle switch OFF.

CAUTION: Before continuing to the next step, turn off and lock the electric power supply to the dryer. Flip all of the circuit breakers in the bottom cabinet OFF and lock the control cabinet doors.

8. Clean out the unload auger and the grain metering rolls. Each unload auger pan is hinged on the left side and secured on the right side with two overcenter latches. Push the handle on the latches down to open the

panels and pull them up overcenter to lock the pans.

9. Clean the fans, burners and heat chambers.
10. Clean all of the screens. If the dryer is equipped with a heat recovery system, remove and clean the bottom covers.
11. Lubricate all bearings with a hand grease gun, see "Lubrication". Do not over lubricate. Too much grease may damage the bearing seals. Lubricate the SCR drive chain and sprockets with engine oil.
12. Loosen the level auger and unload auger drive belts.

MAINTENANCE

CAUTION: Do not allow children or bystanders near the dryer while it is being adjusted and/or serviced.

Lubrication

CAUTION: To prevent accidental starting of the motors during lubrication, turn off and lock the electric power supply to the dryer. Flip all of the circuit breakers in the bottom cabinet OFF and lock the control cabinet doors.

NOTE: Use a hand grease gun to lubricate bearings. Use a good grade of bearing grease and **do not** over lubricate. Too much grease may damage the bearing seals. Avoid getting grease on any of the belts.

Change the oil in the SCR drive gear box after the first two weeks of operation. Use Mobil SHC 634 oil or equivalent. Gear box capacity is ¾ pint. Also change the oil at the start of each drying season.

Every 100 Hours

1. Lubricate the unloading auger front bearing and the front bearing on each grain metering roll, see Figure 29.



Figure 29

2. All other bearings used on the dryer are prelubricated and require no further lubrication.

Periodically

1. Remove the oil level plug (top one) on the end of the SCR drive gear box, see Figure 30. The oil level should be even with the bottom of the hole. If not, remove the vent plug on top of the gear box and add Mobil SHC 634 oil or equivalent until it just runs out. Install the level and vent plug.
2. Oil SCR drive sprockets and chain with engine oil. Be careful not to get oil on the belts.

CAUTION: The line may be very hot.

B. When the vaporizer coil is positioned correctly in the flame, the LP Gas line coming out of the fan housing from the vaporizer coil to the pressure regulator should feel very warm, but not so hot that you cannot hold your hand on it.

C. If it feels cool, the vaporizer coil is not close enough to the flame. If it is very hot, the vaporizer coil is too close to the flame.

D. Shut the burner and both fans off.

CAUTION: Turn off and lock the electric power supply to the control cabinet.

E. Go into the plenum chamber and move the coil closer to or away from the flame, see Figure 19.

F. After the adjustment has been made, turn on the electric power supply. Restart the fans and burner, and recheck temperature.

11. **LP Gas Only** - With the burner operating, check the reading on the gas pressure gauge in the manifold see Figure 18. It should be approximately 12 to 20 pounds (less in mild weather). If not, loosen the locknut on the pressure regulator adjusting screw, see Figure 18. Turn the adjusting screw IN to increase and OUT to decrease pressure.

NOTE: After the dryer has been operating for several hours the pressure regulator(s) will be functioning properly. It will not be necessary to adjust them on future start-ups.

Setting Burner Operating Temperature

NOTE: Refer to the "Suggested Burner Operating Temperature Setting Chart" on page 18. Temperatures shown are initial settings and may have to be adjusted for local crop and weather conditions.

1. With the burners operating, set the operating temperature by adjusting the modulating valve.
2. Turn the "T" handle on the modulating valve IN to INCREASE temperature and OUT to DECREASE temperature, see Figure 20. There is a temperature gauge on the side of the control cabinet for each burner.

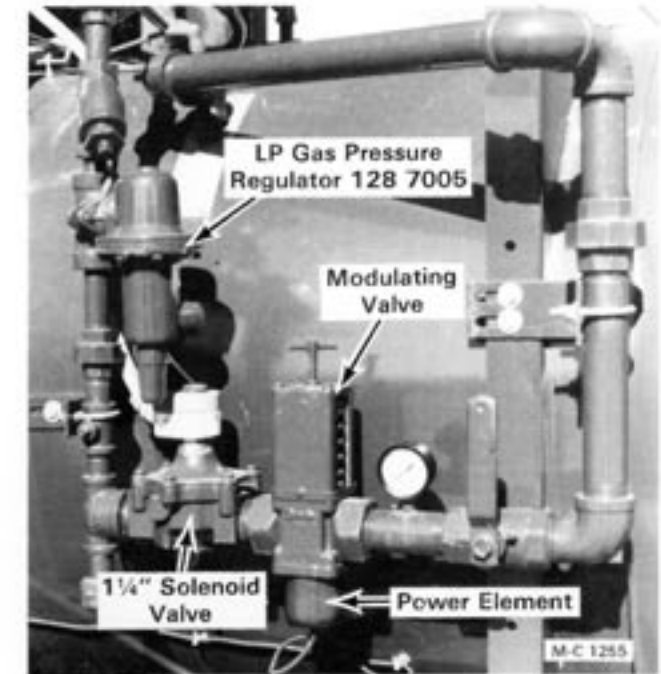

Figure 18 - LP Gas

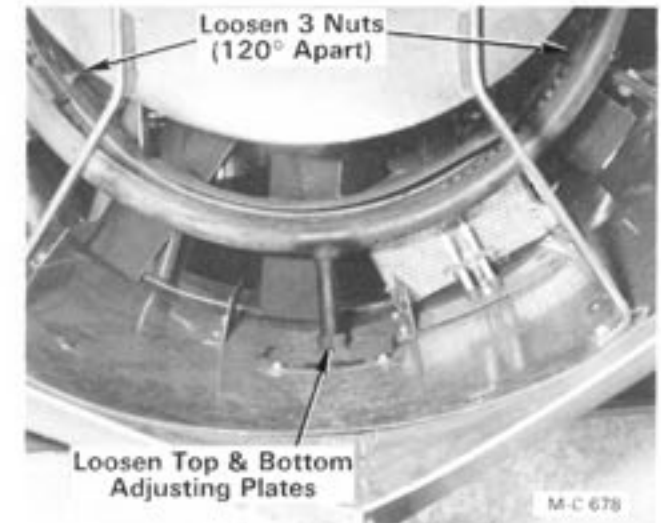

Figure 19 - LP Gas

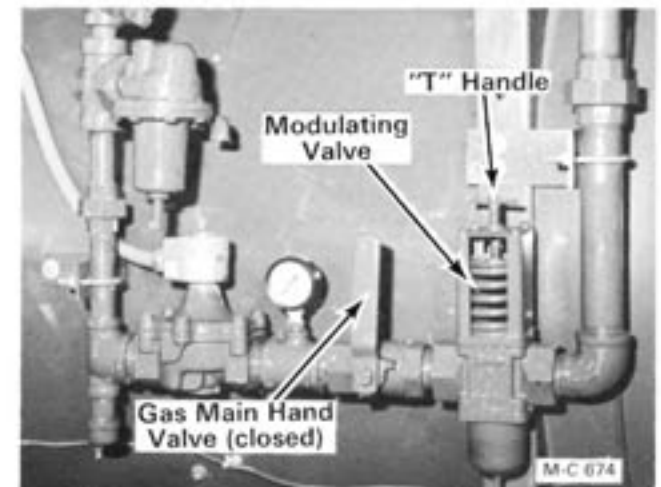

Figure 20 - LP Gas

- After the burner operating temperature has been set for both burners, close the gas main hand valves, flip the ignition switches off and turn the fans off.

NOTE: After the dryer has been operating for several hours the modulating valves will be functioning properly. It will not be necessary to adjust them on future start-ups unless the burner operating temperature is to be changed.

Suggested Burner Operating Temperature Settings (°F)

IMPORTANT: Use this chart as a starting point for drying the crops listed. Depending on the condition of the crop, you may have to increase or decrease the temperature shown. When drying seed grain, use lower temperatures.

Dryer Model	Corn		Sorghum & Wheat		Sunflower Oats, Barley Soybeans	
	Dry & Cool	All Heat	Dry & Cool	All Heat	Dry & Cool	All Heat
670 & 970	230	235	170	170	140	140
	Cool	200	Cool	150	Cool	130
690	—	235	—	170	—	140

OPERATING INSTRUCTIONS

Operation of the Discharge System (See Figure 21)

- The grain metering rolls are driven by a 1/3 HP direct current motor and gearbox. The speed of the motor in manual is controlled by a potentiometer (SCR drive speed control) located on the control panel, see Figure 22. The speed control dial is graduated from 0 (slow) to 10 (fast).
- A grain temperature sensing thermistor probe is located in the grain column on the right side of the dryer. It sends the grain temperature reading to the Moisture-Matic®II control on the component mounting panel in the control cabinet. The moisture control is adjusted by turning the moisture control dial (potentiometer) on the control panel. (See Figure 22)
- When the discharge metering roll switch is in the AUTOMATIC position, the Moisture-Matic®II moisture control controls the SCR drive motor.
- Change the speed manually to establish a discharge rate to give you the desired moisture content.

- After the discharge rate has been steady for 3 hours or more and the moisture content has been consistent for the same amount of time you are ready to switch from manual to automatic.
- The Moisture-Matic®II control when in automatic will change the speed of the discharge metering rolls automatically to compensate for varying incoming moisture contents.

AUTOMATIC MOISTURE CONTROL SYSTEM

There is a direct relationship between grain temperature and grain moisture and any change in grain temperature will mean a change in grain moisture. If the temperature of the grain goes down, the moisture content will have increased. If the temperature of the grain goes up, the moisture content will have gone down.

The automatic moisture control on M-C Dryers maintains uniform moisture content of the grain coming out of the dryer by changing the unloading rate or the speed which the grain is flowing through the dryer. The automatic moisture control system controls the moisture content by sensing the temperature of the grain in the drying section.

Restarts



CAUTION: If the outside temperature went below freezing (32°F) after the dryer was shut down, check to be sure that the grain in the lower part of the grain drying columns or in the metering rolls are not frozen. Frozen grain would prevent the dryer from unloading, which could possibly result in a fire.

- If the grain is frozen, start the bottom burner to thaw it out or clear it by hand as follows:
 - The lower portion of the grain columns and the metering rolls are accessible from inside the dryer.
 - Open the dryer rear lower door.
 - There is a clean-out in every lower inside screen. Remove lower screen covers, see Figure 28. Reinstall the lower screen covers and close the dryer rear door.
- Flip all of the toggle switches on the control panel to the OFF position. Turn on the electric power supply to the dryer.
- LP Gas** - Open the tank supply valve, hand valve at the LP Gas inlet hose and the liquid line flip valve for each burner.
- Natural Gas** - Open the gas supply valve.
- Flip the control circuit toggle switch ON. Then push it up to the START position and release it.
- Start the bottom fan. When it comes up to speed, start the top fan.
- Start the burners. Flip the level auger toggle switch to AUTOMATIC
- Push the discharge auger spring loaded toggle switch up and release it. It will move down to the ON position.
- Flip the discharge metering roll toggle switch to the AUTOMATIC position to begin discharging grain.
- The moisture control will automatically control the metering rolls to maintain the desired moisture content.

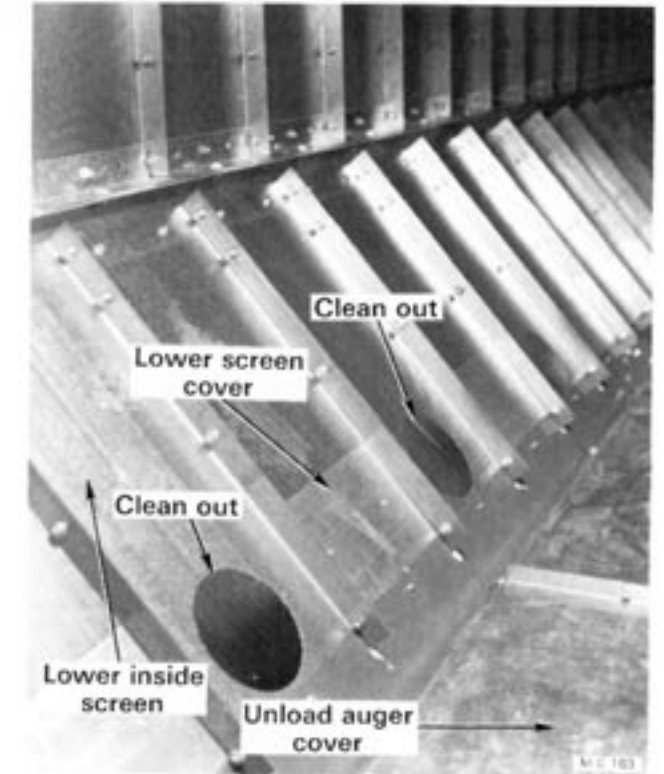

Figure 28

Final Shut Down

When finishing a crop or at the end of the season all of the grain in the dryer must be dry before the dryer is completely unloaded.

- When wet grain level is below sight glass, flip the discharge metering roll switch OFF.
- Run the burners until all the grain is at the desired moisture content (approx. 5 minutes per point of moisture to be removed).
- When the grain is dry, close the LP Gas supply valve at the tank or close the natural gas supply valve. Operate the burners until the flame goes out. Flip the ignition switches OFF.
- Close the gas main hand valves (handle 90° to the piping).
- LP Gas** - Close the liquid line flip valve for each burner (handle down) and the hand valve at the LP Gas inlet hose.
- Run the fans approximately 20 minutes to cool the grain in the dryer, then turn them off.

- When the problem has been corrected, flip the control circuit switch OFF, then ON to reset the Grain Flow Timer. Flip it up to the START position and release it, the READY light will go on.
- Flip the level auger switch to MANUAL. Restart the fans, burner(s) and discharge auger. Flip the level auger switch to the AUTOMATIC position. The level auger .1 to 8 minute delay will be activated if the level auger panel light is on calling for grain.

CAUTION: Do not allow anyone to be in the hopper as the level auger will start automatically.

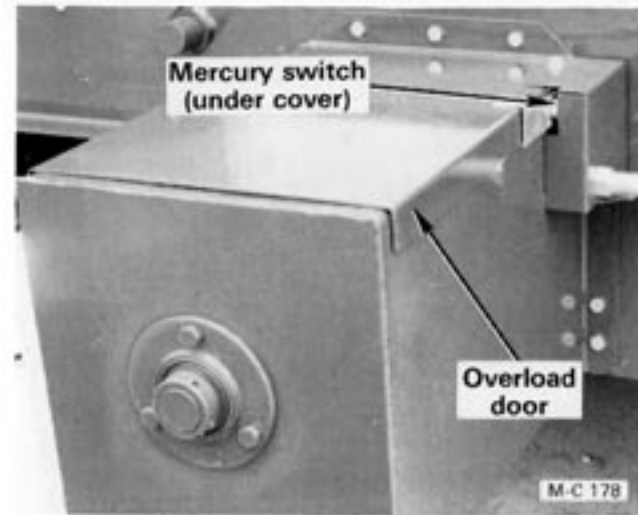

Figure 26

Rear Discharge Overload Door

- If the customer supplied grain take away system fails, the dryer will continue to discharge grain until the rear discharge overload door, Figure 26, is raised by the grain.
- When the overload door raises, the dryer will shut down and all of the lights except the 115V POWER ON light will be out. The Grain Flow Timer will automatically reset.
- When the problem has been corrected and the rear discharge overload door closes, the control circuit ON and the high limit lights will be on. Flip the control circuit switch up to the start position and release it, the READY light will be on.
- The level auger delay will be activated if the level auger switch is in the AUTOMATIC position and the level auger bin switch in the hopper is calling for grain.

CAUTION: Do not allow anyone to be in the hopper as the level auger will start automatically.

- Flip the ignition switches OFF and restart the fans, burners and discharge auger.

Control Cabinet Heat Bulb

- The heat bulb in the upper control cabinet, Figure 27, will always be on when the electric power supply to the dryer is on. It does not have an ON-OFF switch.
- The bulb supplies heat to help keep the electrical components in the cabinet dry.

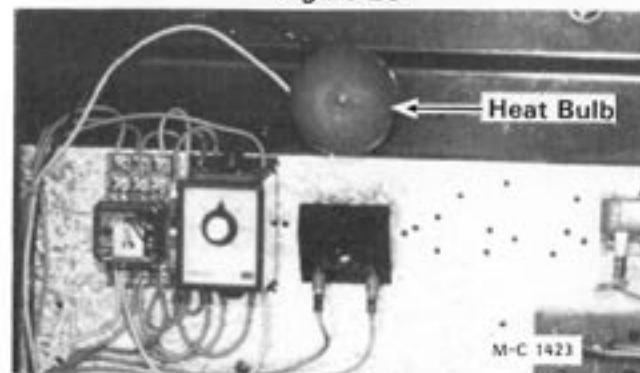

Figure 27

Temporary Shut Down

- Close the LP Gas supply valve at the tank or close the natural gas supply valve. Operate the burners until the flame goes out. Flip the ignition switches OFF.
- Close the gas main hand valves (handles 90° to the piping).
- LP Gas** - Close the liquid line flip valve for each burner (handle down) and the hand valve at the LP Gas inlet hose.
- Flip the discharge metering roll, level auger and discharge auger toggle switches OFF.
- Run the fans approximately 20 minutes to cool the grain in the dryer, then turn them OFF. Flip the control circuit toggle switch OFF.
- Turn off and lock the electric power supply to the dryer.

NOTE: Do not turn the 115V electric power supply off if the heat bulb in the control cabinet is to remain on.

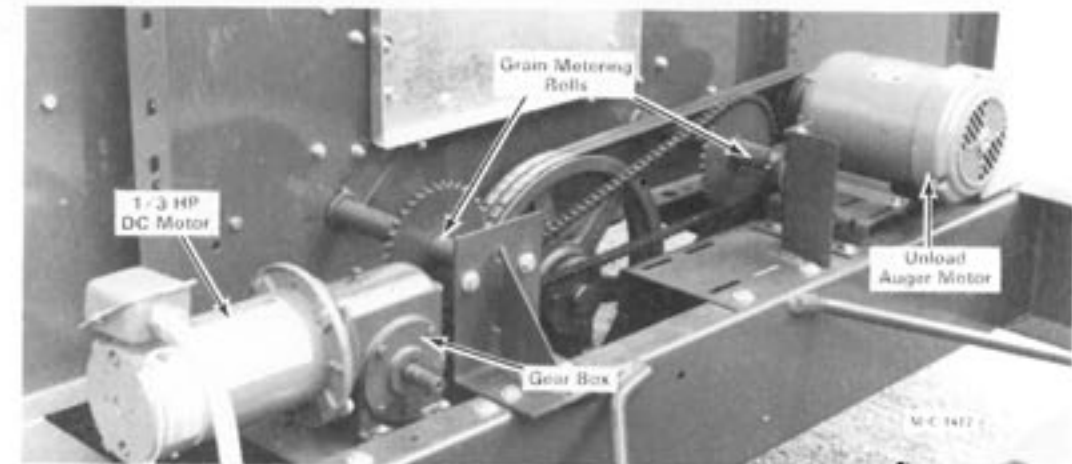

Figure 21

The moisture control is sensing temperature and reacting to it by slowing down or speeding up the rate of unload.

SWITCHING FROM MANUAL TO AUTOMATIC

- See #5 again. (Very important)
- Keep the metering rolls switch in manual.
- Turn the moisture control dial to balance the Moisture-Matic®II to the point that both the (-) and the (+) lights are off. At that point the Moisture-Matic®II is calibrated to the moisture content established in the manual setting.
- Switch the metering roll switch to the automatic position.
- Now the manual speed control is out and the discharge rate is being controlled completely by the Moisture-Matic®II system.
- The discharge speed on the DC volt meter should be the same as when in manual but will begin to change automatically.
- When moisture content of the incoming grain changes (wetter or dryer), the discharge rate will change automatically. If the speed should slow down because the incoming grain is wetter the (-) light will come on and you will see the speed slow down until it has automatically re-adjusted itself. When adjusted for that condition the (-) light will go out and the discharge speed will remain until another change is needed.

If the discharge speed should increase because the incoming grain is drier the

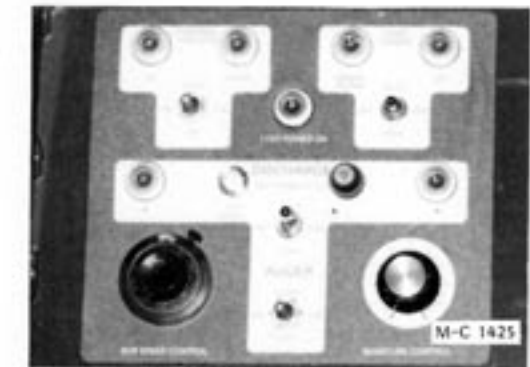
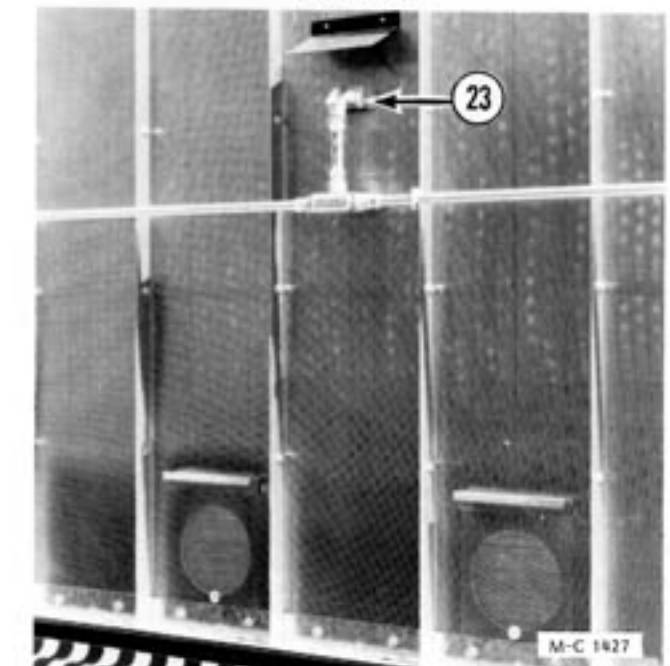

Figure 22



Ref. 23 - Moisture-Matic®II Sensing Probe

(+) light will come on and you will see the speed increase until the speed is readjusted. When adjusted for that condition the light will go out and the discharge speed will remain until another rate change is needed.

The system will automatically change speed (+) and (-) to keep the discharge moisture content at the level you were at in manual.

Grain Metering Roll Discharge Rate Chart		
SCR Drive Dial Setting	16' Dryers Bu./Hr. (approx.)	24' Dryers Bu./Hr. (approx.)
0	75	114
1	149	225
2	287	432
3	427	640
4	564	847
5	703	1055
6	841	1262
7	979	1470
8	1117	1677
9	1256	1885
10	1329	1995

M-C 806

Figure 24

MOISTURE CONTROL SETTING AND ADJUSTMENTS WHEN IN AUTOMATIC

The discharge rate will change to keep moisture content the same as when in manual. However, if you want to change the discharge moisture content when operating in automatic, simply turn the moisture control dial up to a higher number for drier grain or down to a lower number for wetter grain. When you turn the dial either the (+) light or the (-) light will come on and you will see the DC volt meter indicator change to reflect the change in speed.

END OF DAY OR DRYER SHUTDOWN

At the time you want to shut off the dryer you can leave the metering roll switch in automatic and the discharge on. As the dryer begins to cool, the discharge speed will slow down automatically until the Moisture-Matic senses cold grain and stops the metering system completely.

NEXT DAY START-UP

You can start the unload system and set the metering system in the automatic position. As the grain warms up the metering system will start slowly and gradually speed up to the normal speed and will even go past the normal speed for a short period. This is normal because on shut down and start up the grain will be a little dryer and the system is automatically moving that grain through to get it out. When the wetter grain comes down again you will see the speed settle down to the normal speed range.

GOING BACK TO MANUAL

At any time you can switch back to manual. Just flip the metering switch to the manual position. At that time the Moisture-Matic®II will be out of the system and the discharge speed will be controlled by the SCR speed control manually. The DC volt meter will indicate the manual speed setting. If you want to unload at the same speed in manual as it was in automatic, readjust the SCR speed dial until the DC volt meter indicates the same DC volts as you had in automatic.

When operating in manual the (+) and (-) lights may be lit. However, they are only indicating what would happen if you were in automatic based on the set point of the moisture control knob. When in manual you can balance the (+) and (-) lights. However, unless you go to the automatic position nothing will change. In the manual position only you will change the discharge rate by adjusting the SCR dial.

Level Auger Operation

Description

There is an adjustable .1 to 8 minute delay in the level auger circuit, see Figure 25. It is activated when the level auger switch is in the AUTOMATIC position and the level auger light is calling for grain.

This delay prevents nuisance starting and stopping of the level auger. If the level auger switch is flipped to OFF and back to the AUTOMATIC position the delay will recycle.

The Grain Flow Timer, Figure 25, will shut the dryer down if there is an insufficient grain supply to fill the hopper. When the level auger starts, the Grain Flow Timer will be activated. When the timer counts down to zero, the dryer will shut down and the Grain Flow light will come on.

Setting the Grain Flow Timer

IMPORTANT: If the timer has not been set, the dryer will shut down when the level auger toggle switch is flipped from MANUAL to AUTOMATIC.

1. Set the adjustable level auger delay, Figure 21, for time desired (.1 to 8 minutes).
2. Flip the level auger switch to the AUTOMATIC position. Turn the timer control knob, Figure 25, to 30 minutes. The level auger will start after the .1 to 8 minute delay if the level auger light is on calling for grain.
3. Check the level auger refill time a minimum of 6 times. The level auger light will come ON when the level auger bin switch in the hopper calls for grain and will go OUT when the hopper is full. The length of time that the level auger light is on is the refill time (including the .1 to 8 minute delay).
4. Average the 6 refill times and reset the Grain Flow Timer, Figure 25, to run 5 minutes longer. For example, if it takes the level auger an average of 5 minutes to refill the dryer, set the Grain Flow Timer to run 10 minutes.

NOTE: The timer does not operate when the level auger toggle switch is in the MANUAL or OFF position.

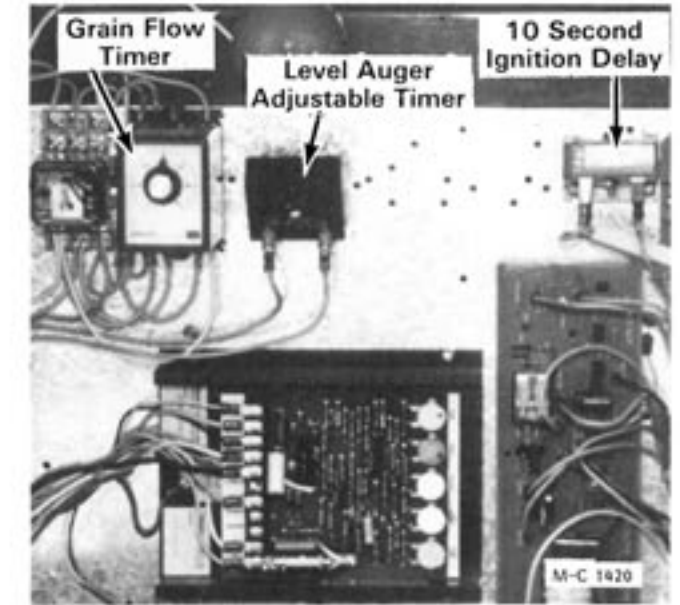

Figure 25

Grain Flow Timer Operation

With the Grain Flow Timer set to run 5 minutes longer than the level auger refilling time, the timer will work as follows:

1. The timer will start when the level auger starts. The red light on the face of the timer will be on and the red needle on the timer dial will start to move to zero.
2. After the level auger refills the dryer and shuts off, the level auger light will go out and the timer red needle will automatically reset. The red light on the face of the timer will be out.
3. If there is an insufficient grain supply, the level auger will continue to run beyond the 5 minute refilling period. When the level auger has run the length of time that the Grain Flow Timer has been set for, the dryer will shut down.
4. The grain flow, high limit, control circuit ON and 115V power ON lights will be on. Flip the level auger switch OFF.

NOTE: When the Grain Flow Timer shuts the dryer down determine the problem.



CAUTION: Turn off and lock the electric power supply to the dryer before any service work is performed.